

**ADO** Alüminyum

AD 55 T YALITIMLI DOĞRAMA SİSTEMİ

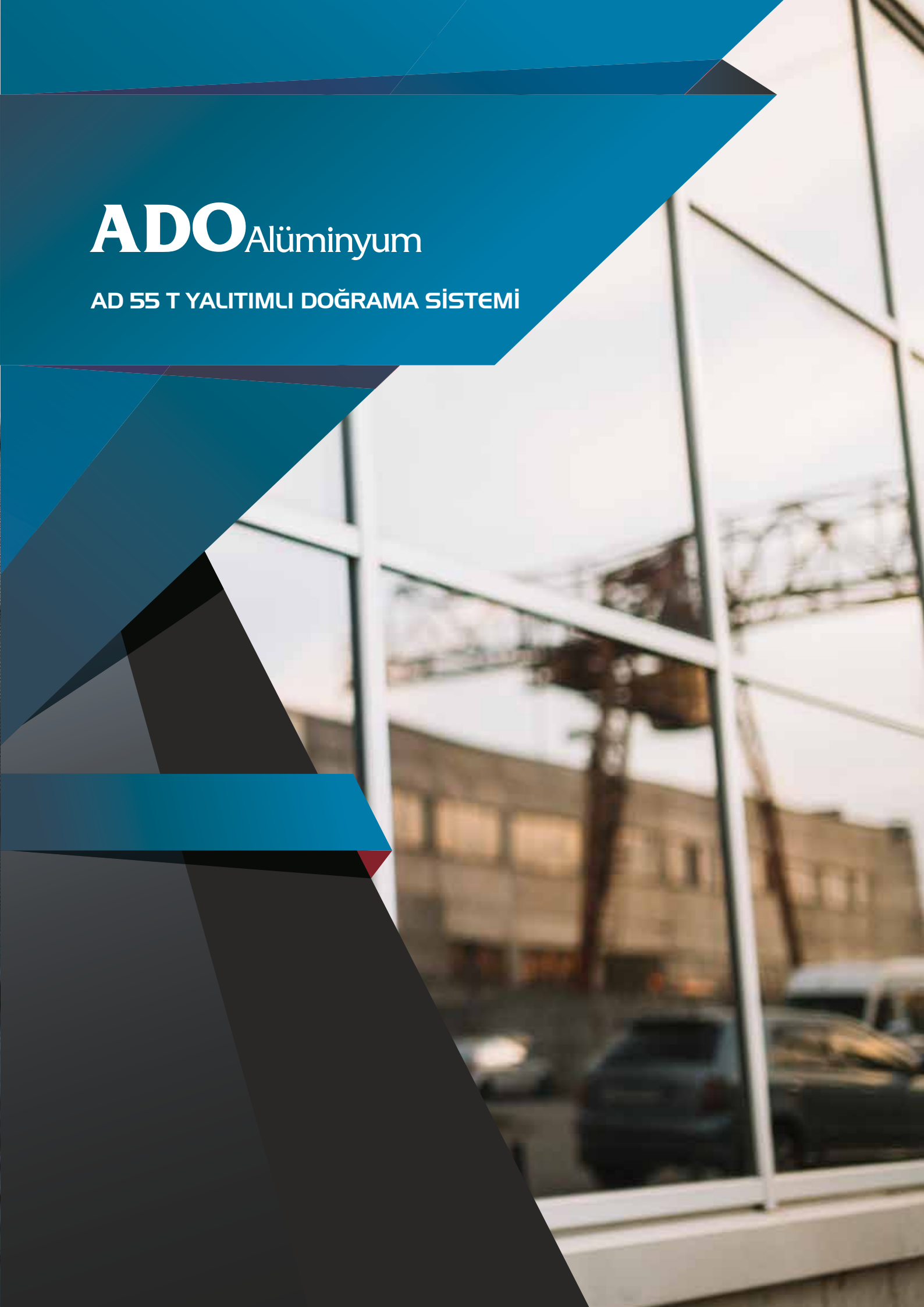



## AD 55 T YALITIMLI DOĞRAMA SİSTEMİ

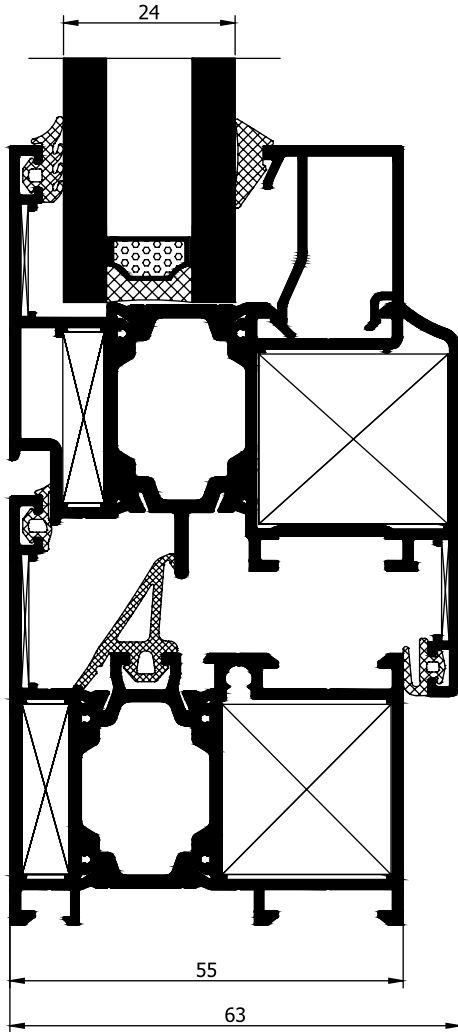

Alüminyum profiller AIMgSi 0,5 - F22 alaşımından ve 12020 Standartlarına göre üretilir.

### Fiziksel Özellikler :

1- Yoğunluk	: 2,71 kg /dm <sup>3</sup>
2- Elastisite Modülü	: 69 kN /mm <sup>2</sup>
3- Direnç	: 20° 33 n Ω .m
4- Erime Noktası	: 600 - 655 °
5 - Genleşme Katsayısı	: 20 - 100° C μ °C <sup>+1</sup>

### Mekanik Özellikler :

1- Elastisite Limiti	: 190 MPa
2 - Kopma dayanıklılığı	: 220 MPa
3- Sertlik	: 67 Brinell
4- Uzama	: % 10

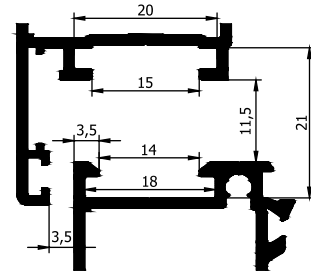

EURO KANAL TİP 1

### SİSTEM BİLGİLERİ :

Profil Genişlik : Kasa 55mm - Kanat 63mm

Isı Bariyer Ölçüsü : 18mm

Isı Geçirgenlik değeri ( Uf ) : 2.520 W/m<sup>2</sup>K

Fitil ( Conta ) : Tüm fitiller Kaucuk Özellikli EPDM dir.

Yapılabilir Pencere Tipleri : İçe açılır - Çift açılır - Çift Kanat açılır - Woswagen Pencere - Pivot pencere tipleri ile İçe açılır Kapı - Dışa açılı Kapılar.

Kullanılabilir Cam Kalınlığı : 4m Tek cam dan 34mm Isı cam kalınlığına kadar EPDM fitil kalınlıkları ve ölçüsüne uygun cam çitası ile ayarlanak istenilen ısı cam kullanım imkanı sunmaktadır.

Su Tahliye : Bütün Profiller Su tahliye sistemine sahiptir.

Bağlantılar : Köşe birleşimlerini sağlamak için Pres Köşe takoz bağlantıları ve Çene L parçaları kullanılarak preslenir. Orta Kayıtlar dışarıdan vidaatılarak ve iç kısımdan takozları ile bağlanır.

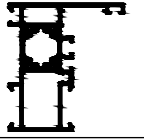
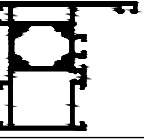
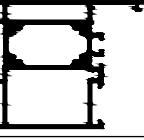
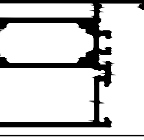
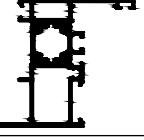
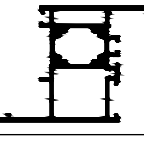
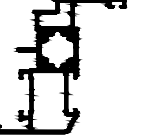
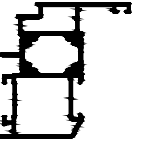
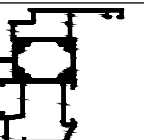
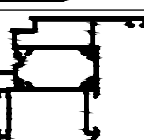
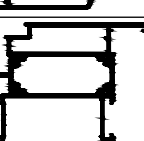
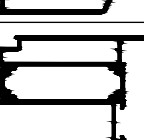

## AD 55 T YALITIMLI DOĞRAMA SİSTEMİ PROFİLLERİ

No:	Profil Şekli	Profil Kod	Profil Adı	Profil Ağırlık ( Kg/m )		
1		AD 21 - 001	KASA PROFİLİ	1,148 Kg/m		
2		AD 21 - 002	KASA PROFİLİ	1,312 Kg/m		
3		AD 21 - 003	KASA PROFİLİ	1,475 Kg/m		
4		AD 21 - 004	KASA PROFİLİ	1,685 Kg/m		
5		AD 21 - 005	PERVAZLI KASA PROFİLİ	1,250 Kg/m		
6		AD 21 - 006	PERVAZLI KASA PROFİLİ	1,530 Kg/m		
7		AD 21 - 007	KANAT PROFİLİ	1,272 Kg/m		
8		AD 21 - 008	KANAT PROFİLİ	1,435 Kg/m		
9		AD 21 - 009	PVC AKSESUAR UYUMLU KANAT PROFİLİ	1,455 Kg/m		
10		AD 21 - 010	KANAT PROFİLİ	1,646 Kg/m		
11		AD 21 - 011	KANAT PROFİLİ	1,815 Kg/m		
12		AD 21 - 012	KANAT PROFİLİ	2,065 Kg/m		

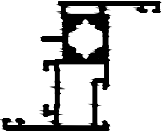
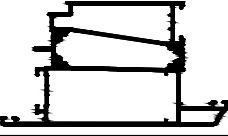
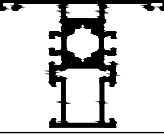
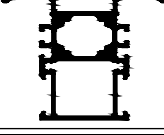
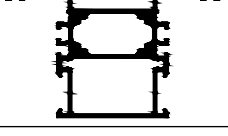
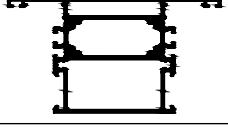
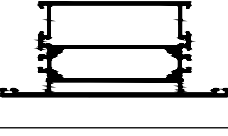
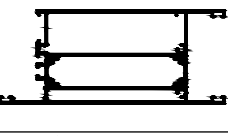
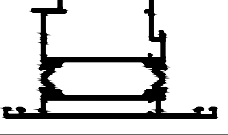
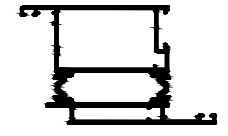
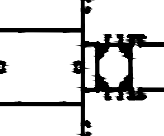
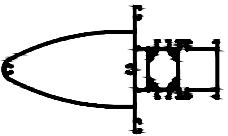
## AD 55 T YALITIMLI DOĞRAMA SİSTEMİ PROFİLLERİ

No:	Profil Şekli	Profil Kod	Profil Adı	Profil Ağırlık ( Kg/m )		
13		AD 21 - 013	KANAT PROFİLİ	1,215 Kg/m		
14		AD 21 - 014	BİNİLİ DIŞA AÇILIM KANAT PROFİLİ	2,235 Kg/m		
15		AD 21 - 015	ORTA KAYIT PROFİLİ	1,295 Kg/m		
16		AD 21 - 016	ORTA KAYIT PROFİLİ	1,458 Kg/m		
17		AD 21 - 017	ORTA KAYIT PROFİLİ	1,620 Kg/m		
18		AD 21 - 018	ORTA KAYIT PROFİLİ	1,835 Kg/m		
19		AD 21 - 019	ORTA KAYIT PROFİLİ	2,392 Kg/m		
20		AD 21 - 020	ETEK PROFİLİ	2,518 Kg/m		
21		AD 21 - 021	HEMYÜZ DIŞA AÇILIM KANAT PROFİLİ	1,750 Kg/m		
22		AD 21 - 022	HEMYÜZ İÇE AÇILIM KANAT PROFİLİ	1,712 Kg/m		
23		AD 21 - 023	TAKVİYELİ ORTA KAYIT PROFİLİ	2,125 Kg/m		
24		AD 21 - 024	TAKVİYELİ ORTA KAYIT PROFİLİ	2,290 Kg/m		

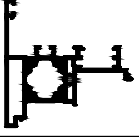
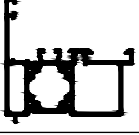
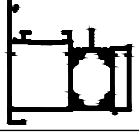
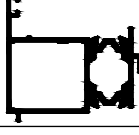
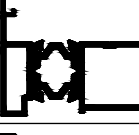
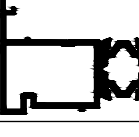
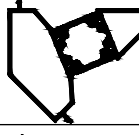
## AD 55 T YALITIMLI DOĞRAMA SİSTEMİ PROFİLLERİ

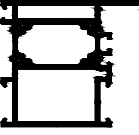
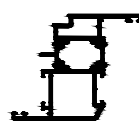
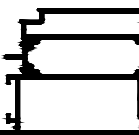
No:	Profil Şekli	Profil Kod	Profil Adı	Profil Ağırlık ( Kg/m )		
25		AD 21 - 025	BİNİLİ KANAT ORTA ADAPTÖR PROFİLİ	1,226 Kg/m		
26		AD 21 - 026	BİNİLİ DIŞA AÇILIM KANAT KASA ADAPTÖR PROFİLİ	1,132 Kg/m		
27		AD 21 - 027	PİVOT PENCERE ADAPTÖRÜ	1,316 Kg/m		
28		AD 21 - 028	HEMYÜZ KAPI KASA ADAPTÖR PROFİLİ	0,992 Kg/m		
29		AD 21 - 029	HEMYÜZ İÇE AÇILIM KANAT ORTA ADAPTÖR PROFİLİ	0,958 Kg/m		
30		AD 21 - 030	HEMYÜZ DIŞA AÇILIM KANAT ORTA ADAPTÖR PROFİLİ	0,930 Kg/m		
31		AD 21 - 031	135 ° KÖŞE PROFİLİ	0,900 Kg/m		
32		AD 21 - 032	90 ° KÖŞE PROFİLİ	1,302 Kg/m		
33		AD 21 - 039	KÖŞE PROFİLİ	1,132 Kg/m		
34		AD 21 - 051	KASA PROFİLİ (2 mm)	1,768 Kg/m		
35		AD 21 - 052	KANAT PROFİLİ (2 mm)	1,710 Kg/m		
36		AD 21 - 053	KANAT PROFİLİ (2 mm)	2,449 Kg/m		

## AD 55 T YALITIMLI DOĞRAMA SİSTEMİ PROFİLLERİ

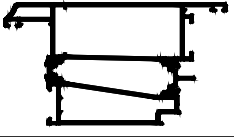
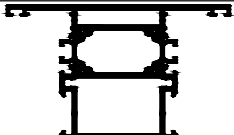
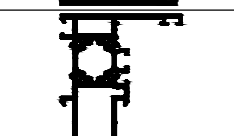
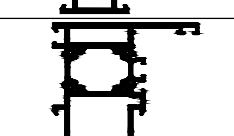
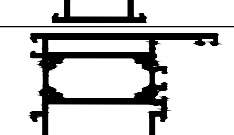
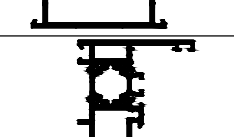
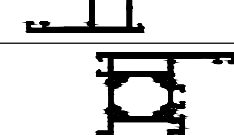
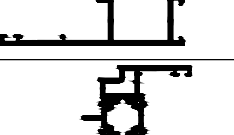
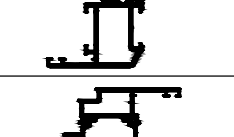
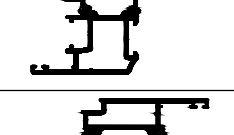
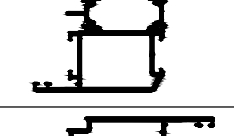
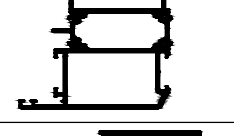

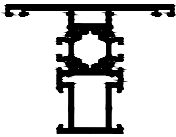
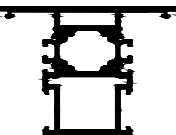
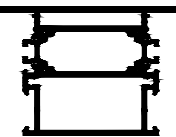
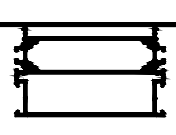
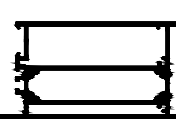
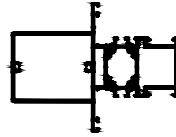
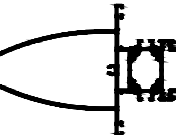
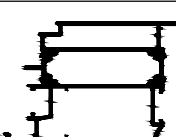
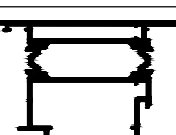
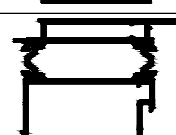
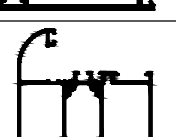
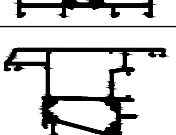

No:	Profil Şekli	Profil Kod	Profil Adı	Profil Ağırlık ( Kg/m )		
37		AD 21 - 054	BİNİLİ DIŞA AÇILIM KANAT PROFİLİ ( 2 mm)	2,676 Kg/m		
38		AD 21 - 055	ORTA KAYIT PROFİLİ (2 mm)	1,936 Kg/m		
39		AD 21 - 056	KASA PROFİLİ (2 mm)	1,343 Kg/m		
40		AD 21 - 057	KASA PROFİLİ (2 mm)	1,558 Kg/m		
41		AD 21 - 058	KASA PROFİLİ (2 mm)	1,980 Kg/m		
42		AD 21 - 059	PERVAZLI KASA PROFİLİ (2 mm)	1,473 Kg/m		
43		AD 21 - 060	PERVAZLI KASA PROFİLİ (2 mm)	1,801 Kg/m		
44		AD 21 - 061	KANAT PROFİLİ (2 mm)	1,500 Kg/m		
45		AD 21 - 062	PVC AKS. UYUMLU KANAT PROFİLİ (2 mm)	1,720 Kg/m		
46		AD 21 - 063	KANAT PROFİLİ (2 mm)	1,920 Kg/m		
47		AD 21 - 064	KANAT PROFİLİ (2 mm)	2,131 Kg/m		
48		AD 21 - 065	KANAT PROFİLİ (2 mm)	1,422 Kg/m		

## AD 55 T YALITIMLI DOĞRAMA SİSTEMİ PROFİLLERİ



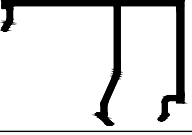
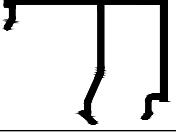
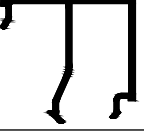
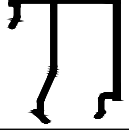
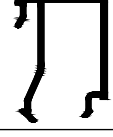
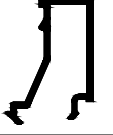

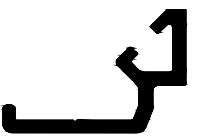
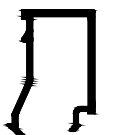



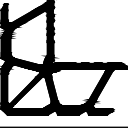
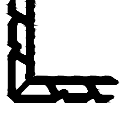

No:	Profil Şekli	Profil Kod	Profil Adı	Profil Ağırlık ( Kg/m )		
49		AD 21 - 066	ORTA KAYIT PROFİLİ (2 mm)	1,512 Kg/m		
50		AD 21 - 067	ORTA KAYIT PROFİLİ (2 mm)	1,724 Kg/m		
51		AD 21 - 068	ORTA KAYIT PROFİLİ (2 mm)	2,146 Kg/m		
52		AD 21 - 069	ORTA KAYIT PROFİLİ (2 mm)	2,781 Kg/m		
53		AD 21 - 070	ETEK PROFİLİ (2 mm)	2,910 Kg/m		
54		AD 21 - 071	TAKVİYELİ ORTA KAYIT PROFİLİ (2 mm)	2,567 Kg/m		
55		AD 21 - 072	TAKVİYELİ ORTA KAYIT PROFİLİ (2 mm)	2,786 Kg/m		
56		AD 21 - 073	PVC AKS. UYUMLU KANAT PROFİLİ	2,080 Kg/m		
57		AD 21 - 078	HEMYÜZ DIŞA AÇILIM KANAT PROFİLİ (2 mm)	2,020 Kg/m		
58		AD 21 - 079	HEMYÜZ İÇE AÇILIM KANAT PROFİLİ (2 mm)	1,980 Kg/m		
59		AD 21 - 088	OVAL KASA PROFİLİ	1,648 Kg/m		
60		AD 21 - 089	PVC AKS. UYUMLU DIŞA AÇILIM KANAT PROFİLİ	1,846 Kg/m		

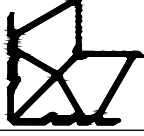



**AD 55 T YALITIMLI DOĞRAMA SİSTEMİ PROFİLLERİ**

No:	Profil Şekli	Profil Kod	Profil Adı	Profil Ağırlık ( Kg/m )		
61		AD20-038	TİJ PROFİLİ	0,130 Kg/m		
62		AD21-033	TEK CAM ÇITA PROFİLİ	0,350 Kg/m		
63		AD21-034	TEK CAM ÇITA PROFİLİ	0,335 Kg/m		
64		AD21-035	ISICAM ÇITA PROFİLİ	0,312 Kg/m		
65		AD21-036	ISICAM ÇITA PROFİLİ	0,295 Kg/m		
66		AD21-037	ISICAM ÇITA PROFİLİ	0,278 Kg/m		
67		AD21-038	ISICAM ÇITA PROFİLİ	0,247 Kg/m		
68		AD21-040	ÇITA PROFİLİ	0,179 Kg/m		
69		AD21-041	ÇITA PROFİLİ	0,140 Kg/m		
70		AD21-087	ISICAM ÇITA PROFİLİ	0,252 Kg/m		
71		AD21-044	KÖŞE TAKOZU	3,030 Kg/m		
72		AD21-045	KÖŞE TAKOZU	3,566 Kg/m		

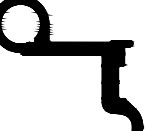



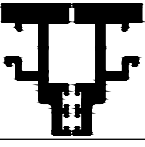

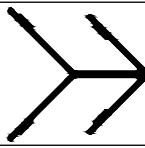
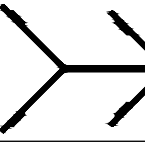
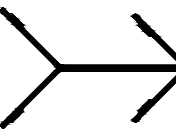
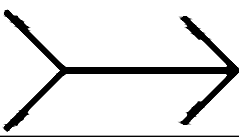
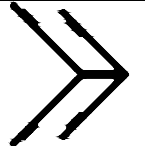
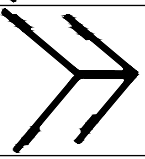
**AD 55 T YALITIMLI DOĞRAMA SİSTEMİ PROFİLLERİ**

No:	Profil Şekli	Profil Kod	Profil Adı	Profil Ağırlık ( Kg/m )		
73		AD21-046	KÖŞE TAKOZU	4,157 Kg/m		
74		AD21-047	KÖŞE TAKOZU	3,220 Kg/m		
75		AD21-048	KÖŞE TAKOZU	5,307 Kg/m		
76		AD21-050	KÖŞE TAKOZU	6,366 Kg/m		
77		AD21-042	ORTA KAYIT BAĞLANTI PROFİLİ	0,327 Kg/m		
78		AD21-043	ORTA KAYIT BAĞLANTI PROFİLİ	0,347 Kg/m		
79		AD21-074	ORTA KAYIT BAĞLANTI PROFİLİ	0,507 Kg/m		
80		AD21-075	ORTA KAYIT BAĞLANTI PROFİLİ	0,444 Kg/m		
81		AD21-076	ORTA KAYIT BAĞLANTI PROFİLİ	0,423 Kg/m		
82		AD21-077	ORTA KAYIT BAĞLANTI PROFİLİ (SETSKURLU)	0,388 Kg/m		
83		AD21-080	MENTEŞE PROFİLİ	0,575 Kg/m		
84		AD21-081	MENTEŞE PROFİLİ	0,640 Kg/m		

**AD 55 T YALITIMLI DOĞRAMA SİSTEMİ PROFİLLERİ**

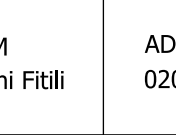
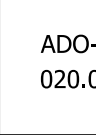
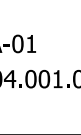
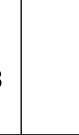
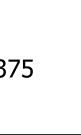
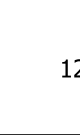
No:	Profil Şekli	Profil Kod	Profil Adı	Profil Ağırlık ( Kg/m )		
85		AD21-049	PİVOT MENTEŞE	3,150 Kg/m		
86		AD16-029	PERVAZ PROFİLİ	1,092 Kg/m		
87		AD20-048	VİDALI KÖŞE BAĞLANTI PROFİLİ	1,079 Kg/m		
88		AD20-049	VİDALI KÖŞE BAĞLANTI PROFİLİ	1,176 Kg/m		
89		AD20-050	VİDALI KÖŞE BAĞLANTI PROFİLİ	1,271 Kg/m		
90		AD20-051	VİDALI KÖŞE BAĞLANTI PROFİLİ	1,415 Kg/m		
91		AD20-052	VİDALI KÖŞE BAĞLANTI PROFİLİ	0,984 Kg/m		
92		AD20-053	VİDALI KÖŞE BAĞLANTI PROFİLİ	1,016 Kg/m		
93						
94						
95						
96						

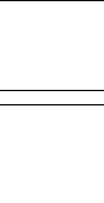
## AD 55 T YALITIMLI DOĞRAMA SİSTEMİ AKSESUARLARI

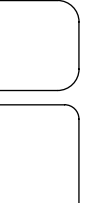
No:	Şekil	İsim	Kod	Koli Bilgileri			
				Mt	Kg		
1		EPDM İç Bini Fitili	ADO-A-01 020.004.001.03	375	12		
2		EPDM Dış Bini Fitili	ADO-A-02 020.005.001.03	571	12		
3		EPDM Dış Cam Fitili	ADO-A-03 020.001.001.03	267	12		
4		EPDM Orta Fitil	ADO-A-04 020.003.001.03	126	12		
5		EPDM Çıta Fitili	ADO-A-05 020.002.001.03	197	12		
6		EPDM Çıta Fitili	ADO-A-06 020.002.002.03	164	12		
7		EPDM Çıta Fitili	ADO-A-07 020.002.003.03	197	12		
8		EPDM Çıta Fitili	ADO-A-08 020.002.004.03	255	12		
9		EPDM Çıta Fitili	ADO-A-09 020.002.005.03	240	12		
10		SAC KÖŞE GÖNYE 39,7x15,7	005.002.001.00				
11		SAC KÖŞE GÖNYE 35x14,2	005.002.002.00				
12		SAC KÖŞE GÖNYE 45x18,7	005.002.003.00				

## AD 55 T YALITIMLI DOĞRAMA SİSTEMİ 1,5 mm KASA PROFİLLERİ

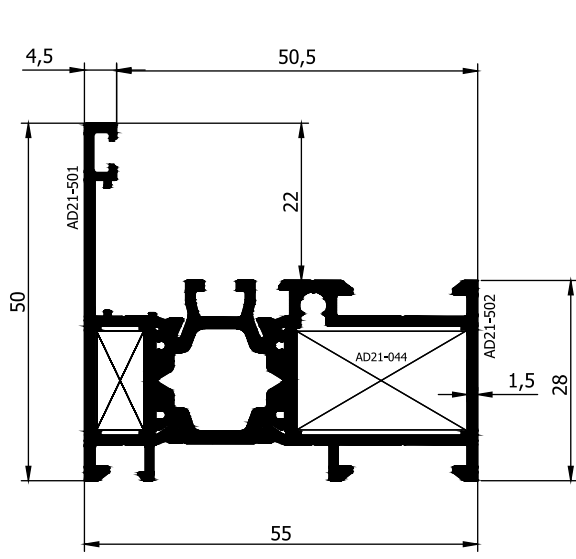

AD 21 - 001 ( 1,148 Kg/m )

Jx : 14,76 cm<sup>4</sup> | Jy : 5,15 cm<sup>4</sup>

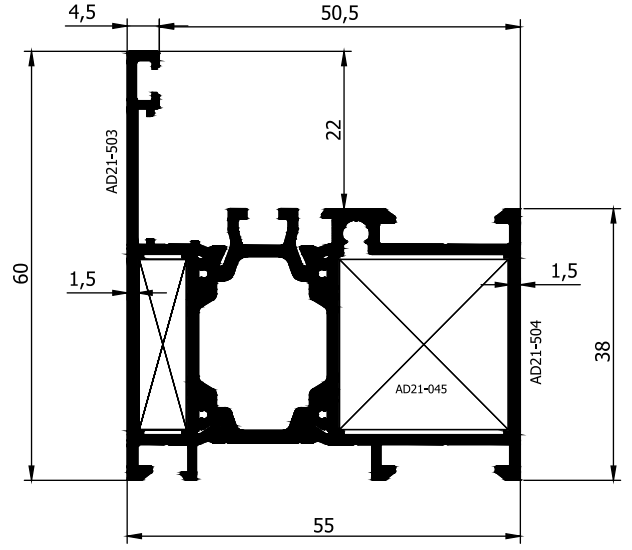

AD 21 - 002 ( 1,315 Kg/m )

Jx : 17,76 cm<sup>4</sup> | Jy : 10,22 cm<sup>4</sup>

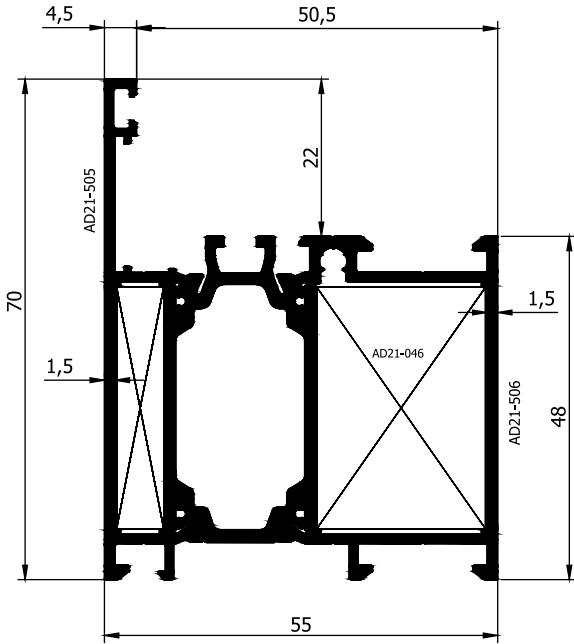

AD 21 - 003 ( 1,475 Kg/m )

Jx : 22,25 cm<sup>4</sup> | Jy : 16,50 cm<sup>4</sup>

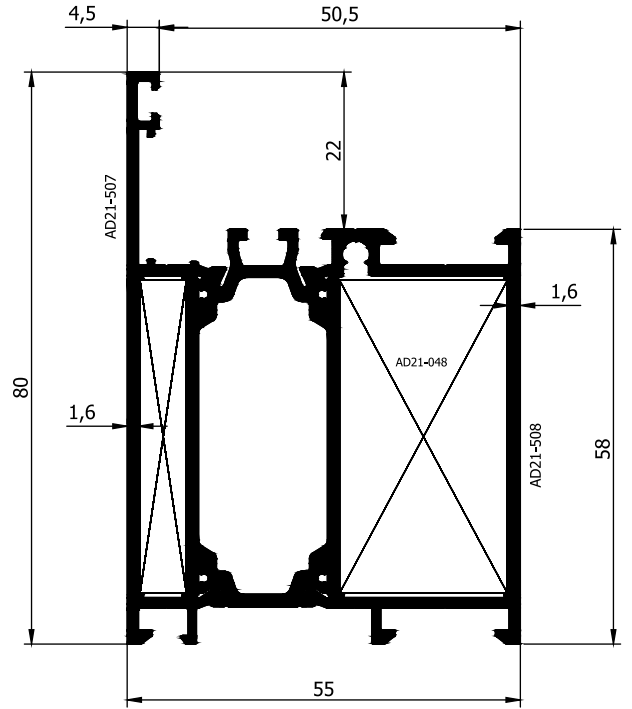

AD 21 - 004 ( 1,685 Kg/m )

Jx : 32,65 cm<sup>4</sup> | Jy : 21,67 cm<sup>4</sup>

Uyarı: Tablodaki profil ağırlıklarımız teorik olup; teslim anındaki tartımız geçerlidir.

**AD 55 T YALITIMLI DOĞRAMA SİSTEMİ  
1,5 mm KASA PROFİLLERİ**

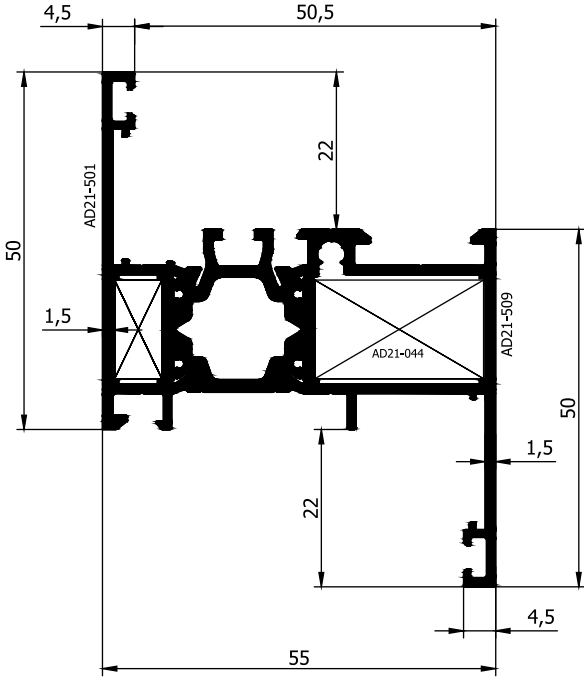

AD 21 - 005 ( 1,250 Kg/m )

Jx : 20,46 cm<sup>4</sup> | Jy : 06,40 cm<sup>4</sup>

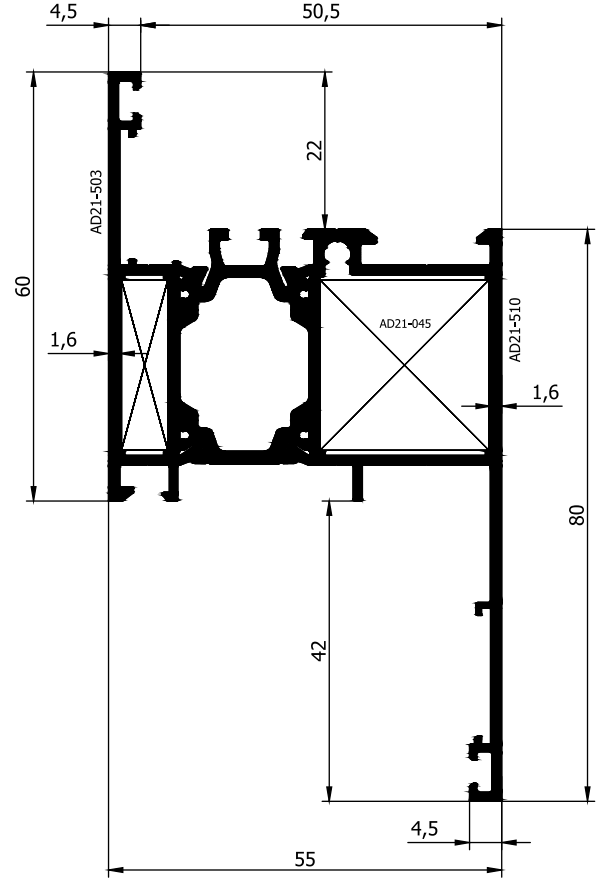

AD 21 - 006 ( 1,530 Kg/m )

Jx : 37,10 cm<sup>4</sup> | Jy : 12,93 cm<sup>4</sup>

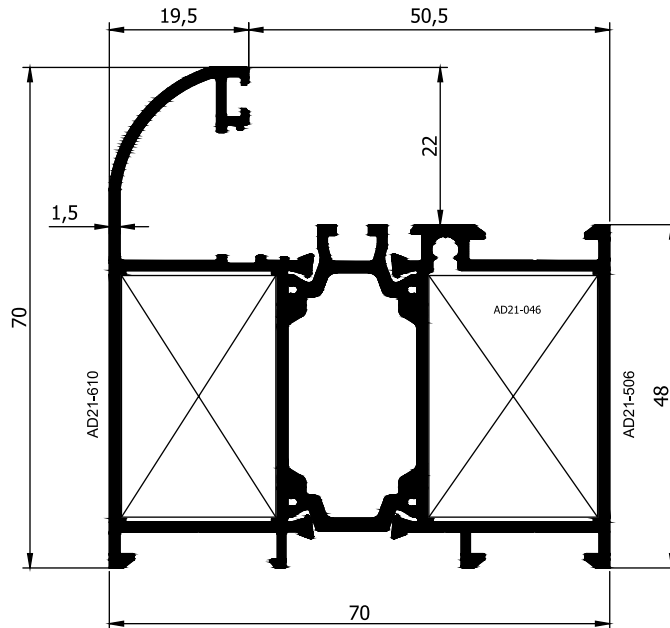

AD 21 - 088 ( 1,648 Kg/m )

Uyarı: Tablodaki profil ağırlıklarımız teorik olup; teslim anındaki tartımız geçerlidir.

## AD 55 T YALITIMLI DOĞRAMA SİSTEMİ 1,5 mm KANAT PROFİLLERİ

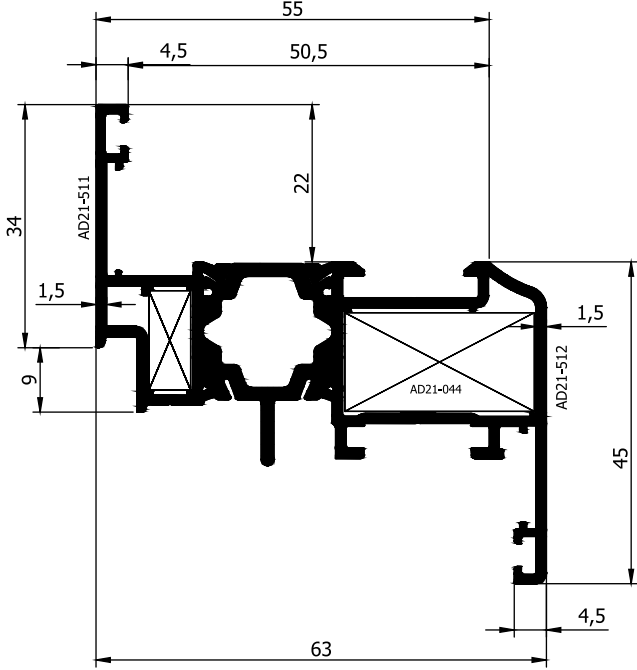

AD 21 - 007 ( 1,272 Kg/m )  
Jx : 24,59 cm<sup>4</sup> | Jy : 4,91 cm<sup>4</sup>

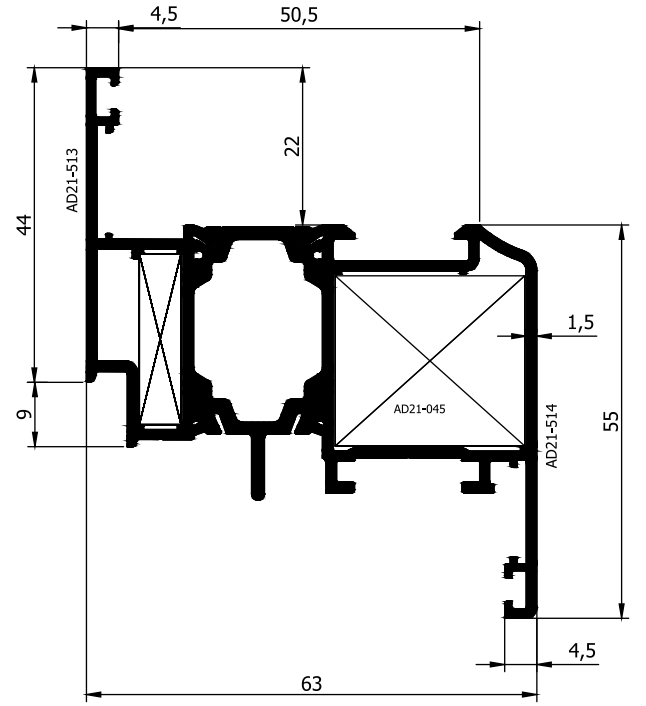

AD 21 - 008 ( 1,435 Kg/m )  
Jx : 29,72 cm<sup>4</sup> | Jy : 9,62 cm<sup>4</sup>

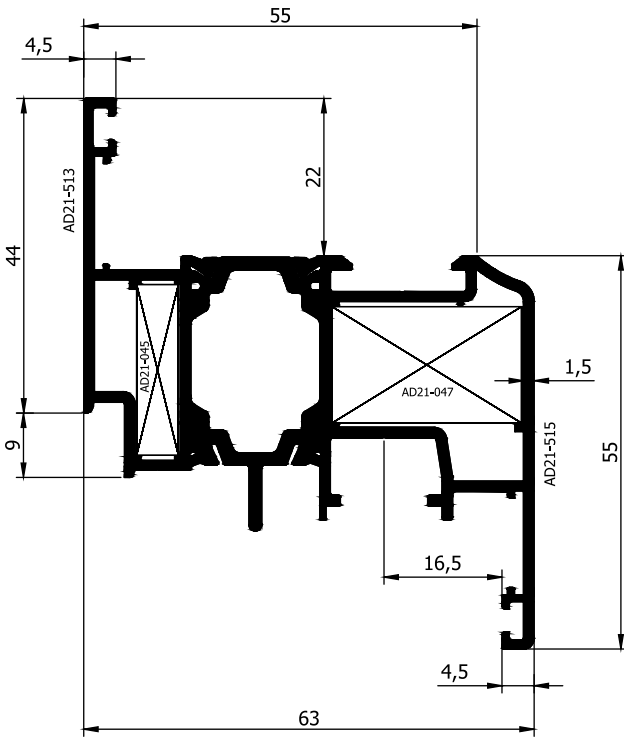

AD 21 - 009 ( 1,455 Kg/m )  
Jx : 29,64 cm<sup>4</sup> | Jy : 9,44 cm<sup>4</sup>

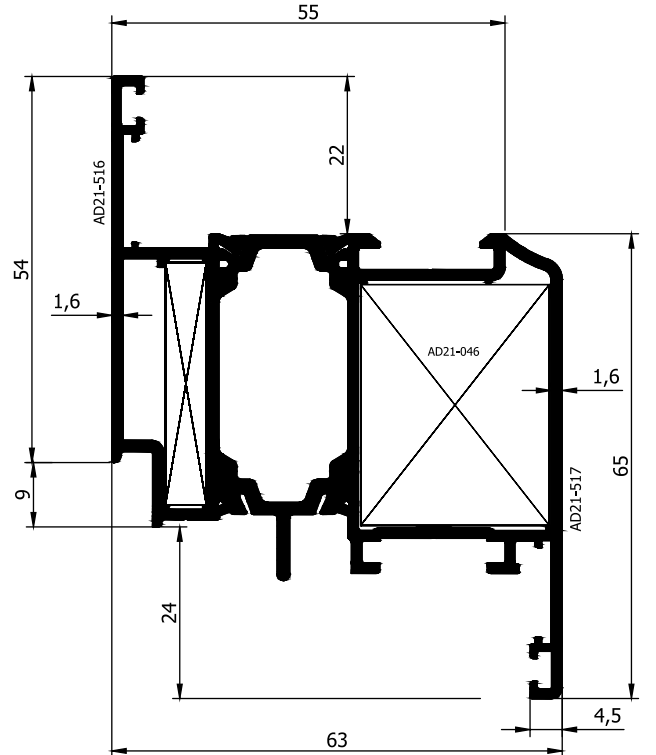

AD 21 - 010 ( 1,646 Kg/m )  
Jx : 37,69 cm<sup>4</sup> | Jy : 16,19 cm<sup>4</sup>

## AD 55 T YALITIMLI DOĞRAMA SİSTEMİ 1,5 mm KANAT PROFİLLERİ

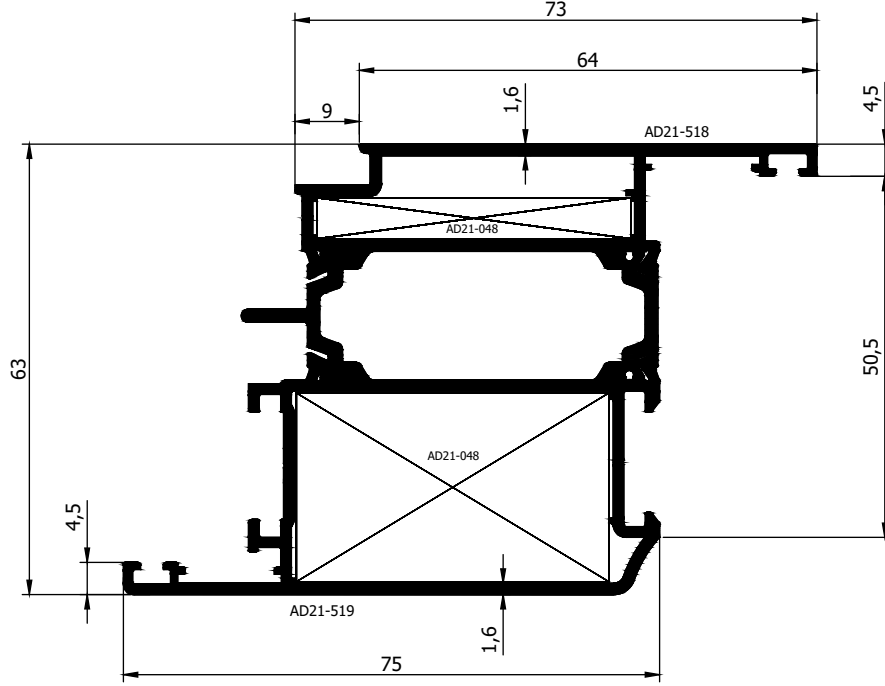

AD 21 - 011 ( 1,815 Kg/m )

Jx : 47,60 cm<sup>4</sup> | Jy : 22,82 cm<sup>4</sup>

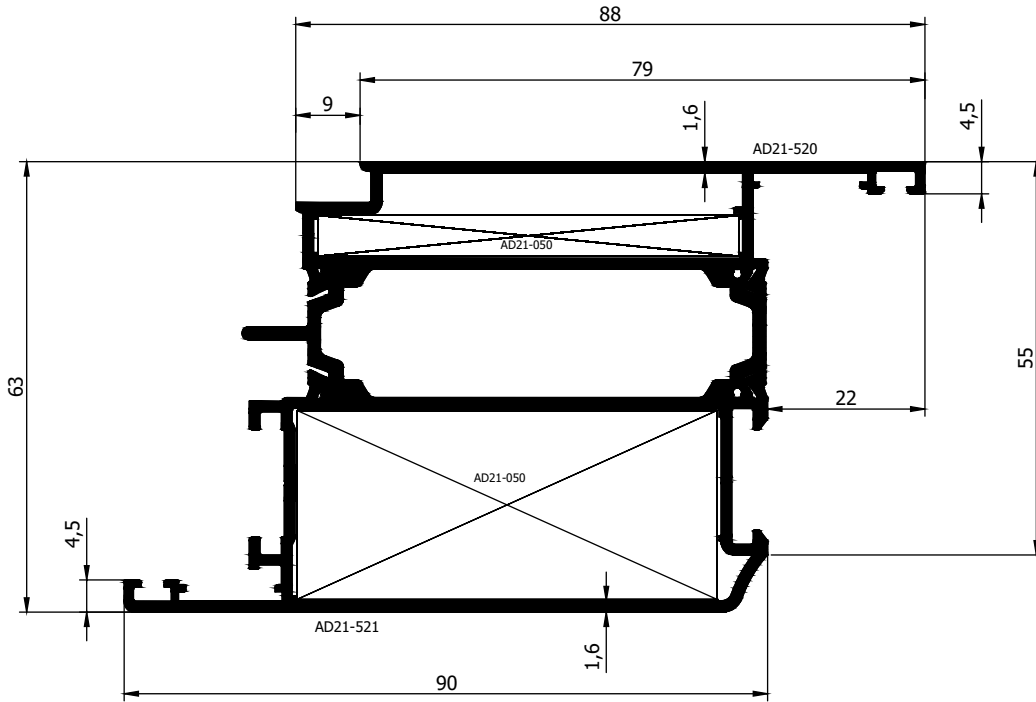

AD 21 - 012 ( 2,066 Kg/m )

Jx : 70,79 cm<sup>4</sup> | Jy : 31,33 cm<sup>4</sup>

Uyarı: Tablodaki profil ağırlıklarımız teorik olup; teslim anındaki tartımız geçerlidir.



AD 55 T YALITIMLI DOĞRAMA SİSTEMİ  
1,5 mm KANAT PROFİLLERİ

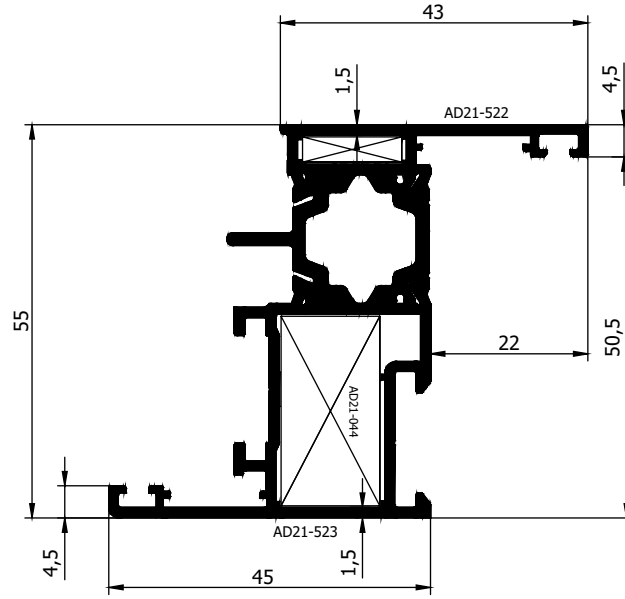

AD 21 - 013 ( 1,215 Kg/m )

Jx : 20,36 cm<sup>4</sup> | Jy : 5,16 cm<sup>4</sup>

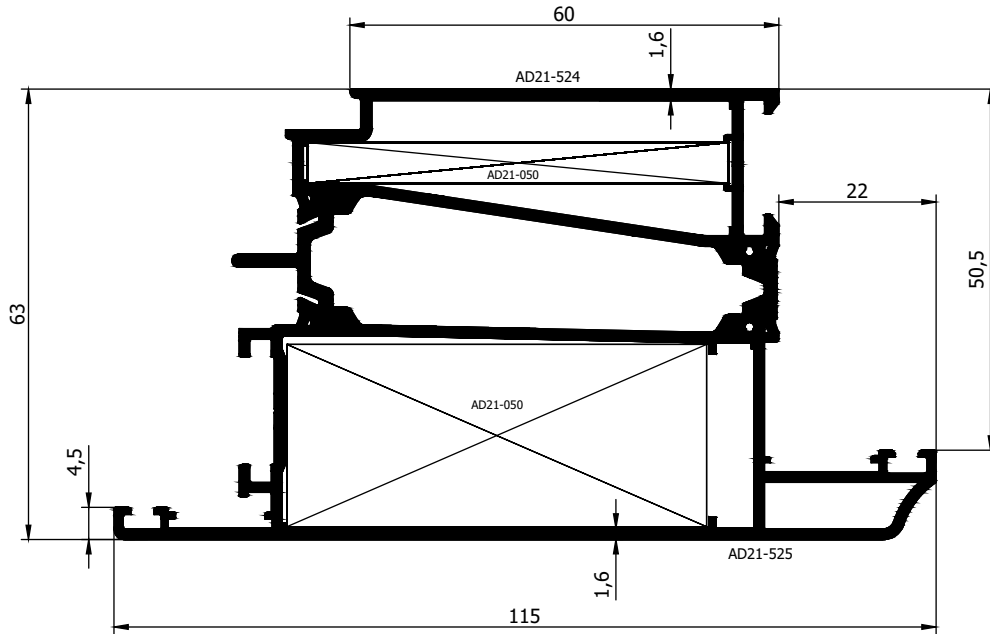

AD 21 - 014 ( 2,235 Kg/m )

Jx : 78,97 cm<sup>4</sup> | Jy : 38,99 cm<sup>4</sup>

## AD 55 T YALITIMLI DOĞRAMA SİSTEMİ 1,5 mm KANAT PROFİLLERİ

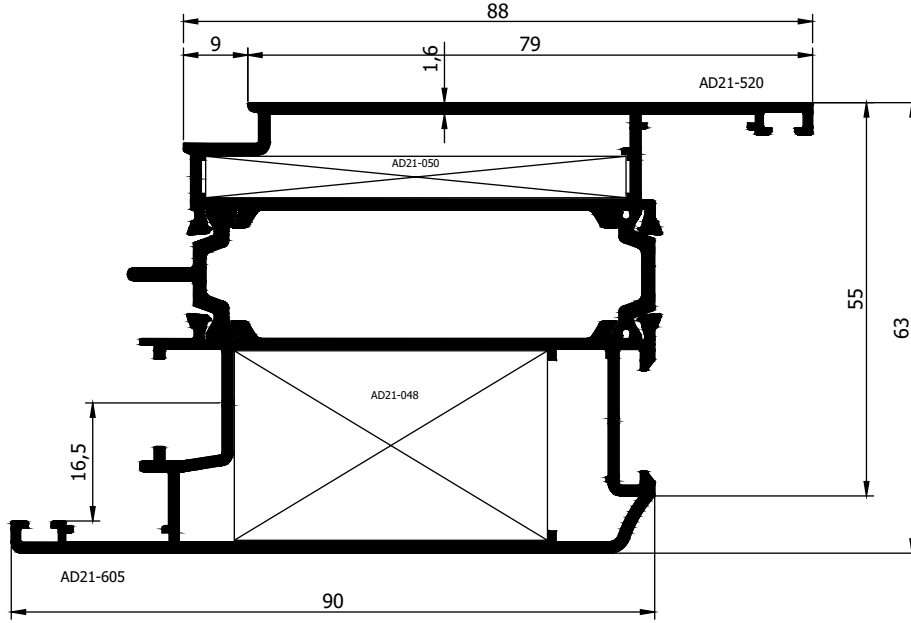

AD21-073 (2,080 Kg/m)

Jx : 69,80 cm<sup>4</sup> | Jy : 31,31 cm<sup>4</sup>

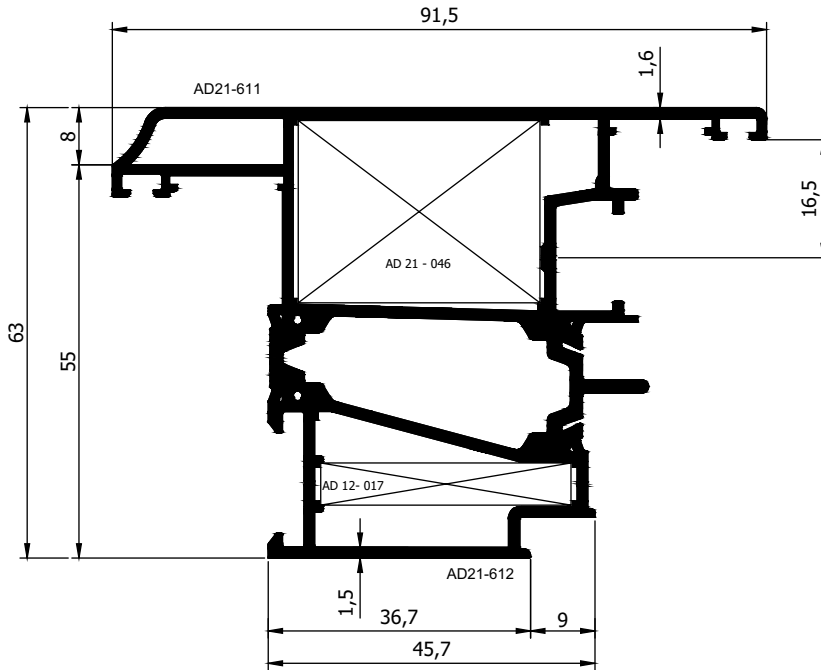

PVC KANALLI DIŞA AÇILIM KANAT PROFİLİ  
AD21-089 (1,846 Kg/m)

## AD 55 T YALITIMLI DOĞRAMA SİSTEMİ 1,5 mm ORTA KAYIT PROFİLLERİ

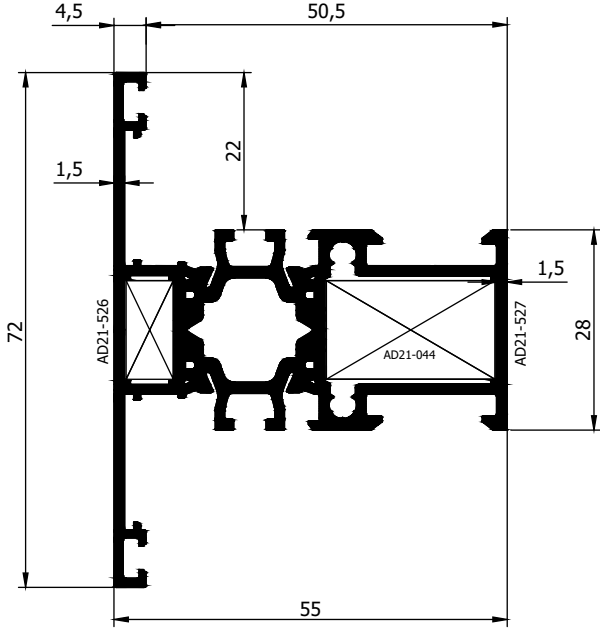

AD 21 - 015 ( 1,295 Kg/m )

Jx : 16,00 cm<sup>4</sup> | Jy : 9,53 cm<sup>4</sup>

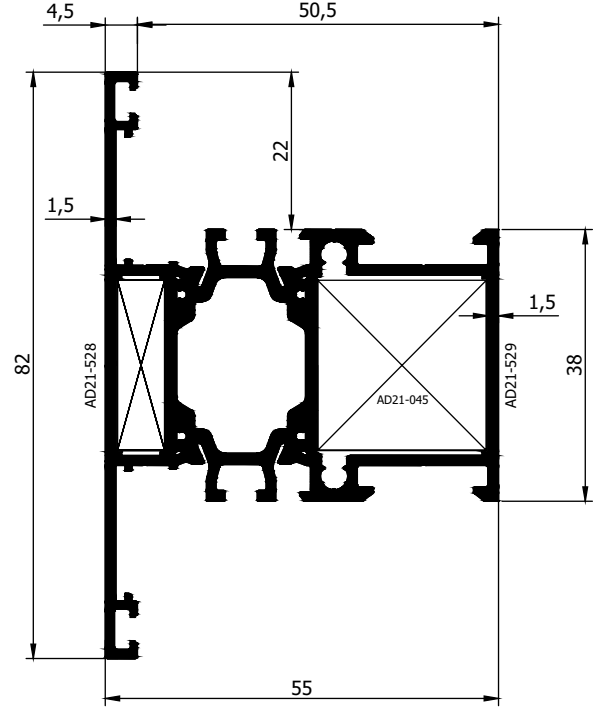

AD 21 - 016 ( 1,460 Kg/m )

Jx : 18,56 cm<sup>4</sup> | Jy : 16,71 cm<sup>4</sup>

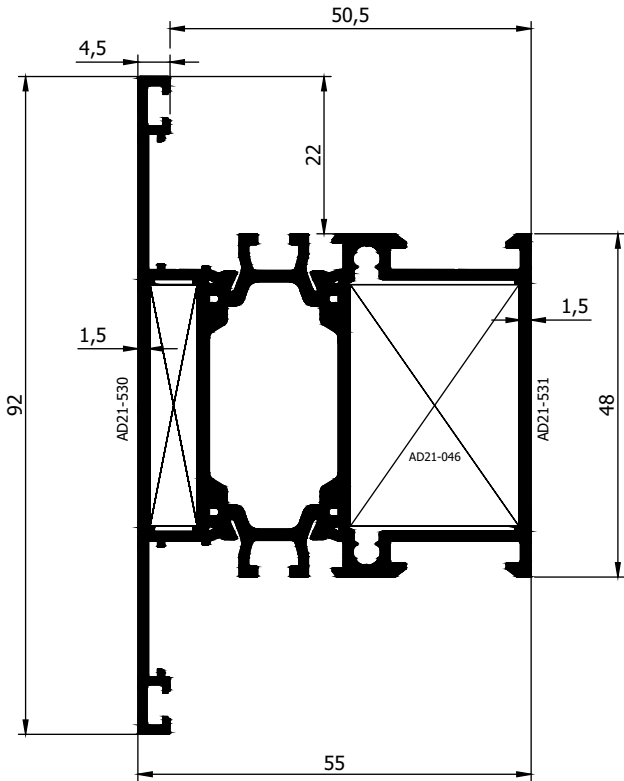

AD 21 - 017 ( 1,620 Kg/m )

Jx : 26,93 cm<sup>4</sup> | Jy : 21,12 cm<sup>4</sup>

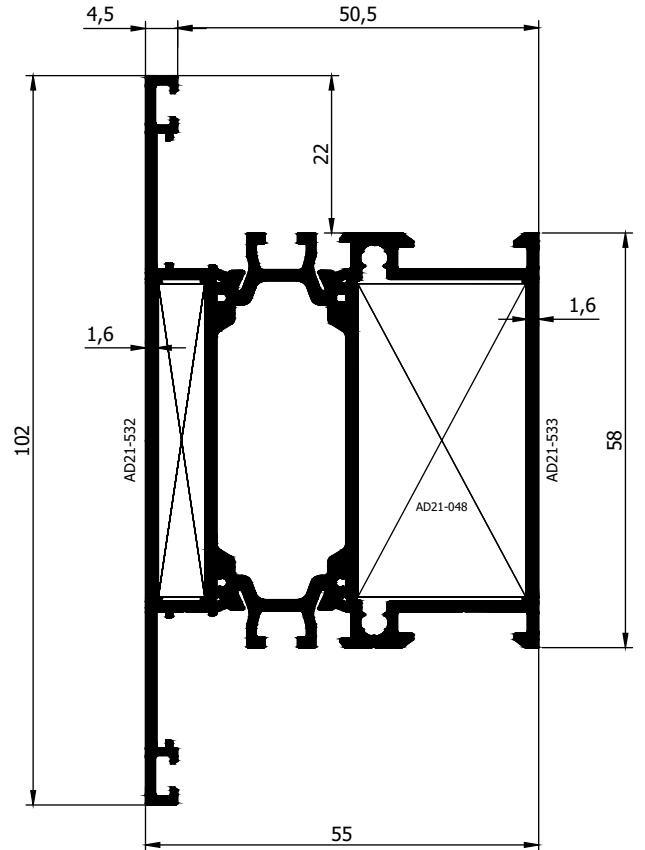

AD 21 - 018 ( 1,835 Kg/m )

Jx : 41,60 cm<sup>4</sup> | Jy : 24,78 cm<sup>4</sup>

**AD 55 T YALITIMLI DOĞRAMA SİSTEMİ  
1,5 mm ETEK PROFİLLERİ**

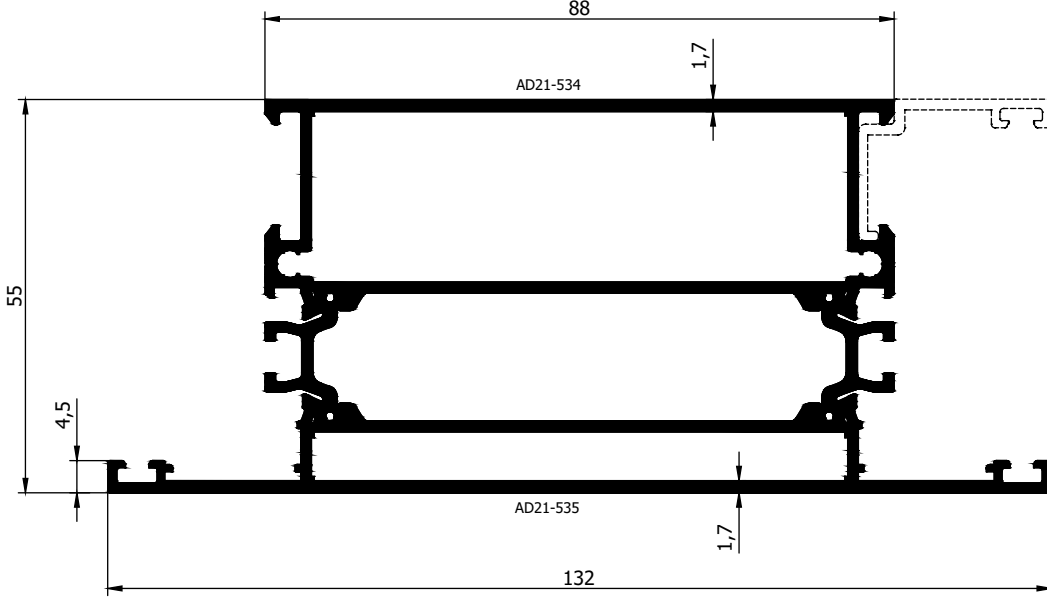

AD 21 - 019 ( 2,390 Kg/m )

Jx : 108,68 cm<sup>4</sup> | Jy : 34,10 cm<sup>4</sup>

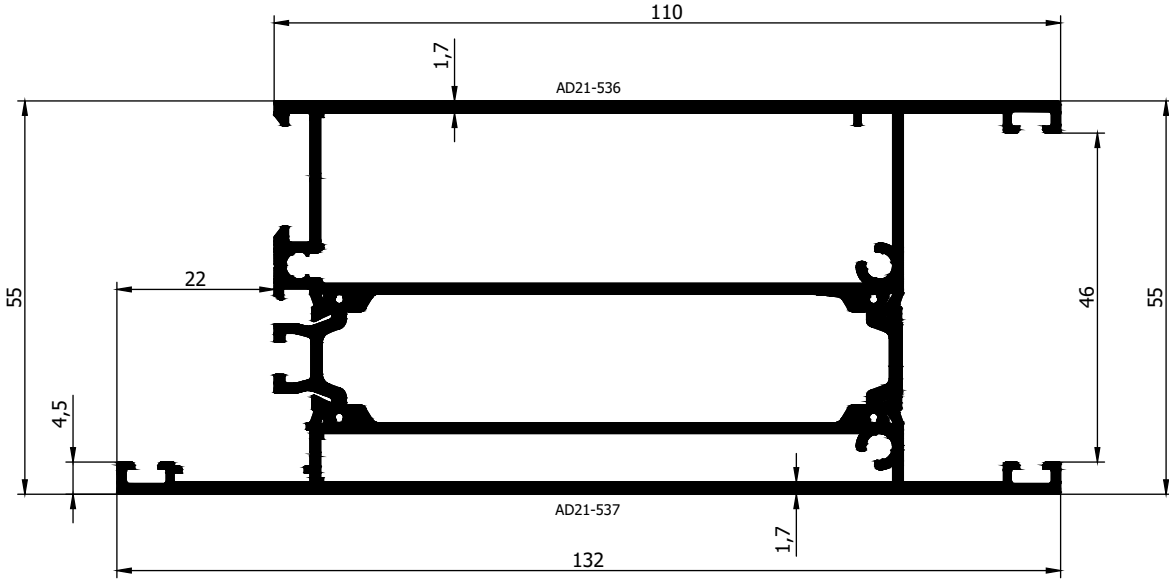

AD 21 - 020 ( 2,520 Kg/m )

Jx : 125,87 cm<sup>4</sup> | Jy : 37,95 cm<sup>4</sup>

**Uyarı: Tablodaki profil ağırlıklarımız teorik olup; teslim anındaki tartımız geçerlidir.**

AD 55 T YALITIMLI DOĞRAMA SİSTEMİ  
1,5 mm HEMYÜZ KANAT PROFİLLERİ

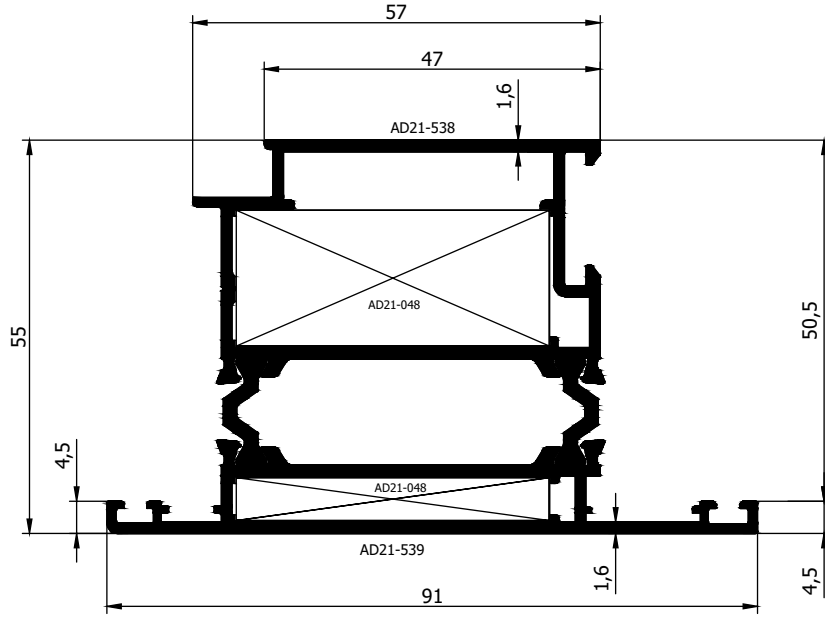

AD 21 - 021 ( 1,750 Kg/m )

Jx : 33,86 cm<sup>4</sup> | Jy : 22,58 cm<sup>4</sup>

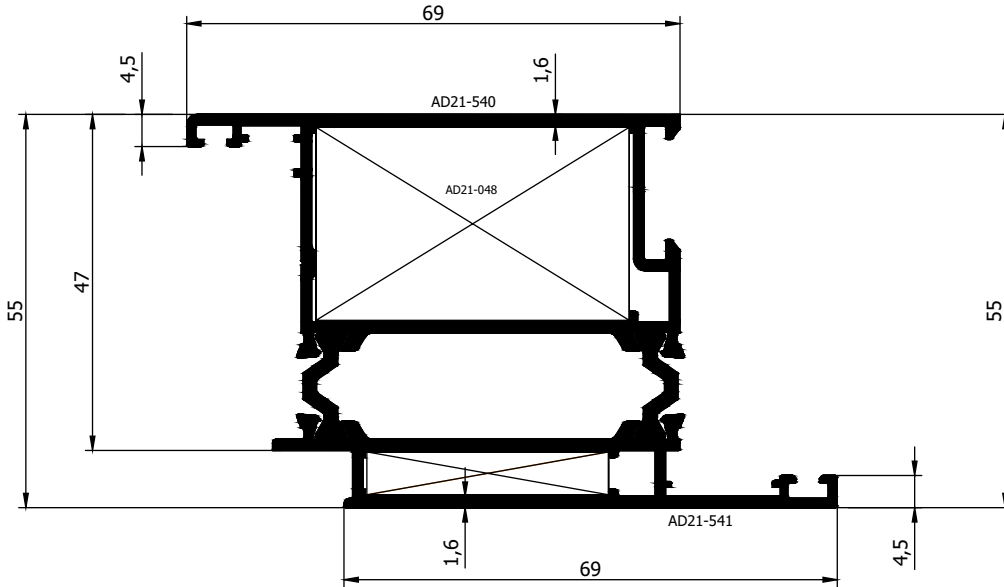

AD 21 - 022 ( 1,720 Kg/m )

Jx : 37,70 cm<sup>4</sup> | Jy : 19,65 cm<sup>4</sup>

Uyarı: Tablodaki profil ağırlıklarımız teorik olup; teslim anındaki tartımız geçerlidir.

## AD 55 T YALITIMLI DOĞRAMA SİSTEMİ 1,5 mm TAKVİYELİ ORTA KAYIT PROFİLLERİ

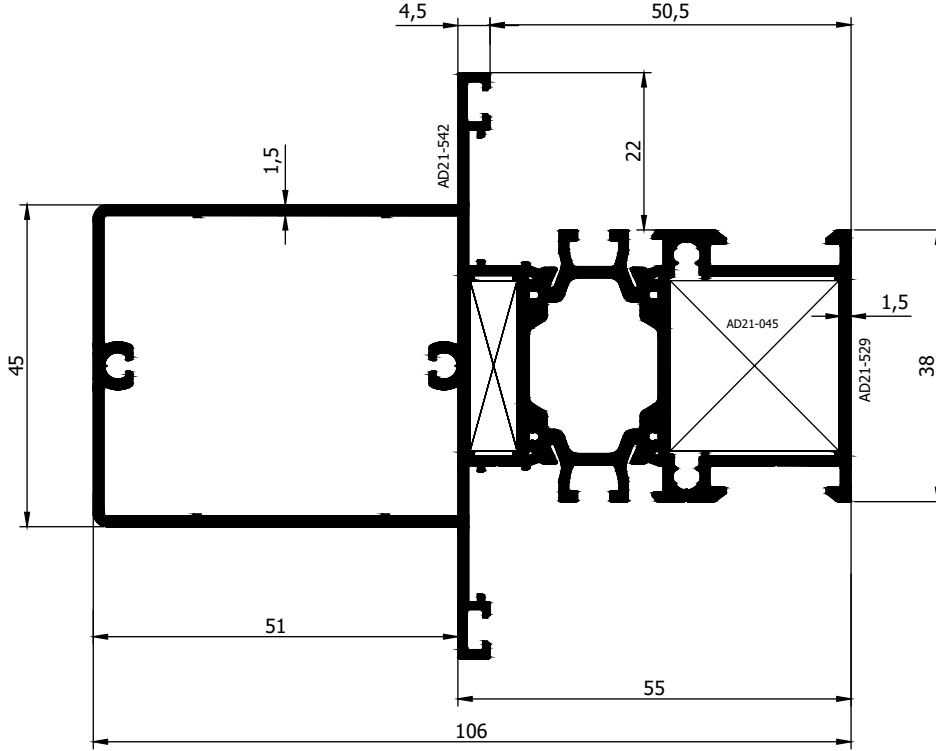

AD 21 - 023 ( 2,125 Kg/m )

Jx : 75,46 cm<sup>4</sup> | Jy : 24,86 cm<sup>4</sup>

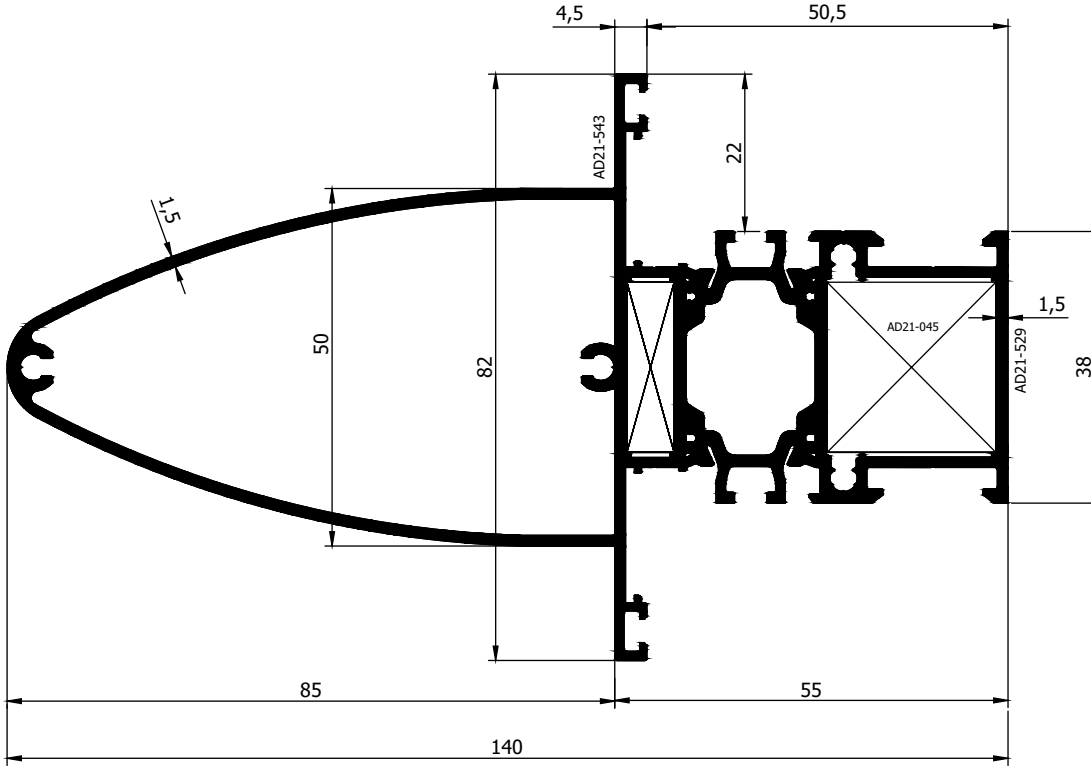

AD 21 - 024 ( 2,290 Kg/m )

Jx : 129,55 cm<sup>4</sup> | Jy : 26,43 cm<sup>4</sup>

Uyarı: Tablodaki profil ağırlıklarımız teorik olup; teslim anındaki tartımız geçerlidir.

## AD 55 T YALITIMLI DOĞRAMA SİSTEMİ 2 mm KASA PROFİLLERİ

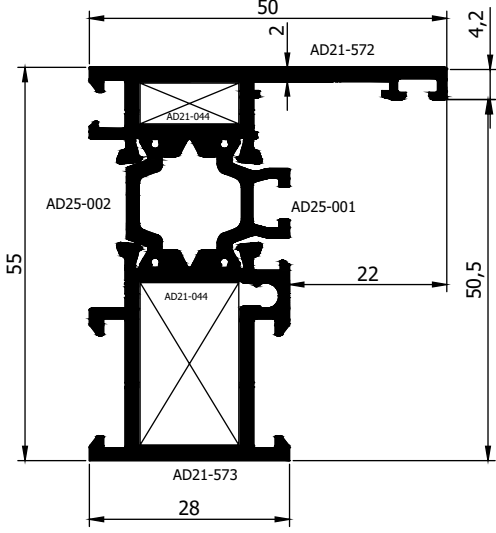

AD 21 - 056 ( 1,343 Kg/m )

Jx : 17,74 cm<sup>4</sup> Jy : 5,83 cm<sup>4</sup>

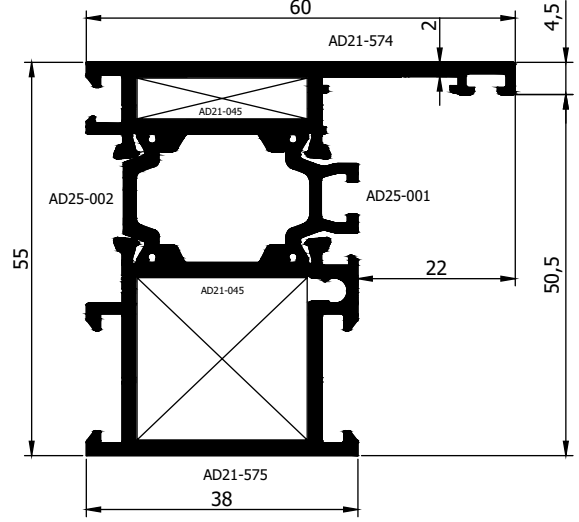

AD 21 - 057 ( 1,558 Kg/m )

Jx : 21,57 cm<sup>4</sup> Jy : 11,63 cm<sup>4</sup>

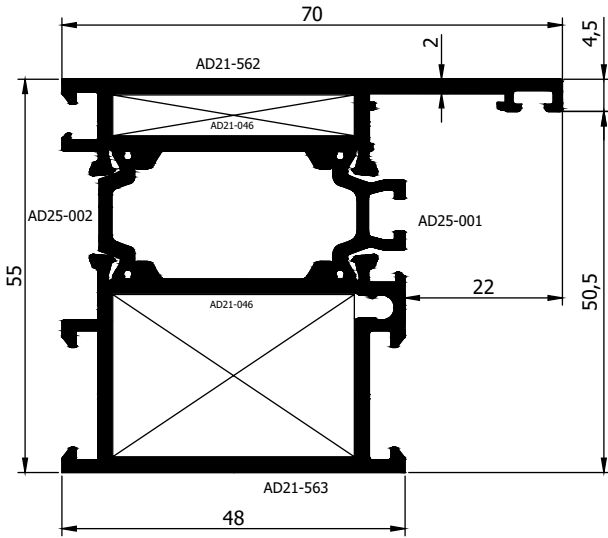

AD 21 - 051 ( 1,768 Kg/m )

Jx : 26,69 cm<sup>4</sup> Jy : 19,29 cm<sup>4</sup>

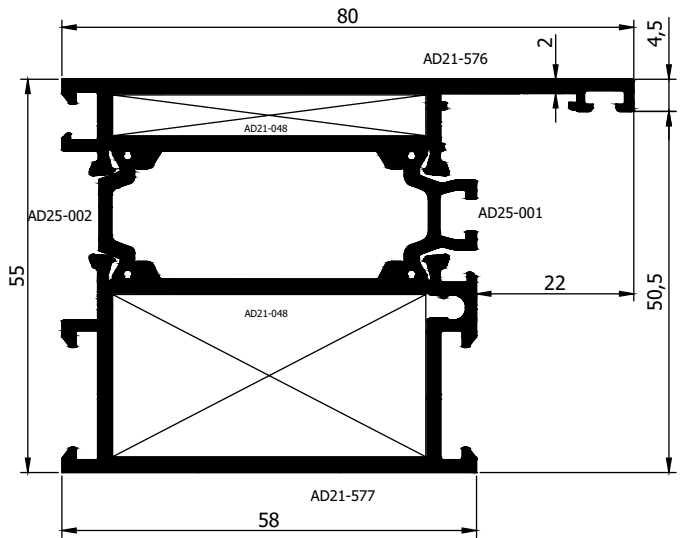

AD 21 - 058 ( 1,980 Kg/m )

Jx : 36,87 cm<sup>4</sup> Jy : 25,41 cm<sup>4</sup>

## AD 55 T YALITIMLI DOĞRAMA SİSTEMİ 2 mm KASA PROFİLLERİ

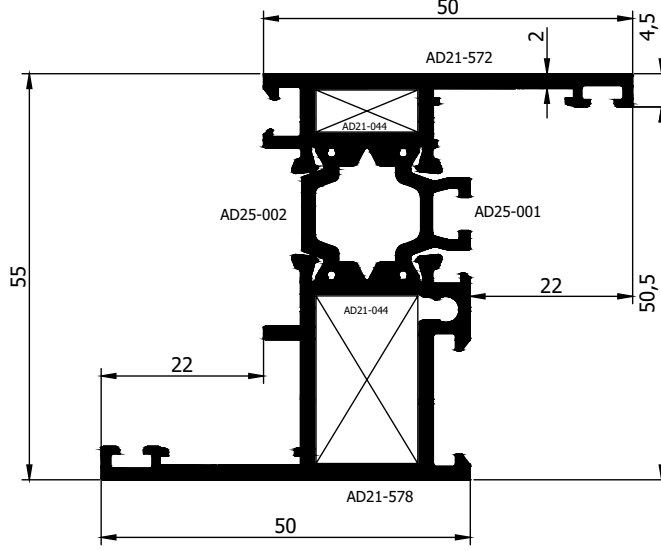

AD 21 - 059 ( 1,473 Kg/m )

Jx : 24,59 cm<sup>4</sup> Jy : 7,30 cm<sup>4</sup>

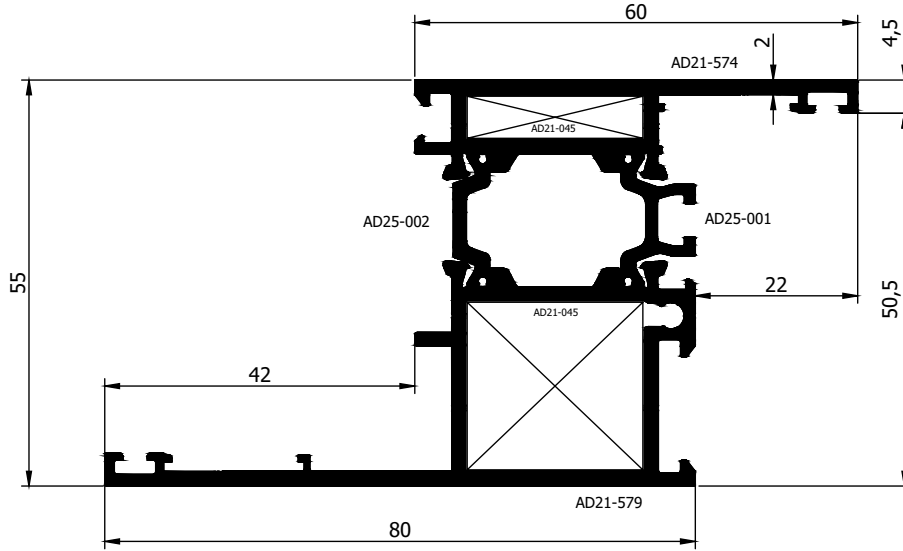

AD 21 - 060 ( 1,801 Kg/m )

Jx : 43,07 cm<sup>4</sup> Jy : 14,92 cm<sup>4</sup>

Uyarı: Tablodaki profil ağırlıklarımız teorik olup; teslim anındaki tartımız geçerlidir.



## AD 55 T YALITIMLI DOĞRAMA SİSTEMİ 2 mm KANAT PROFİLLERİ

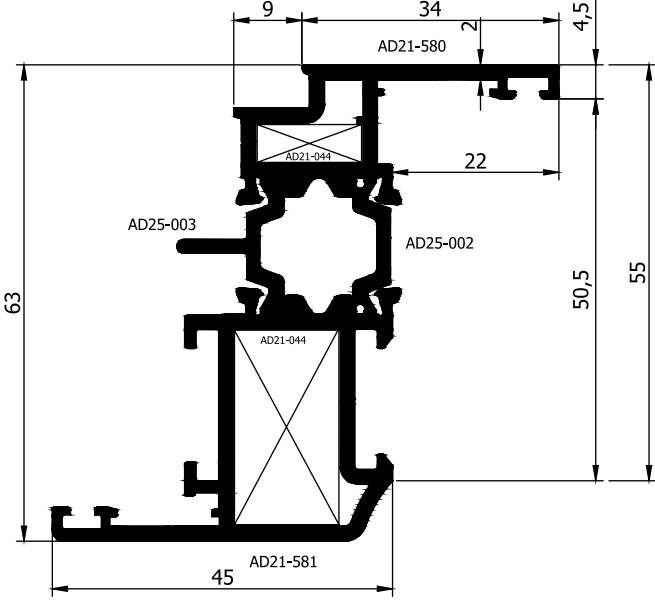

AD 21 - 061 ( 1,500 Kg/m )

Jx : 29,40 cm<sup>4</sup> Jy : 5,65 cm<sup>4</sup>

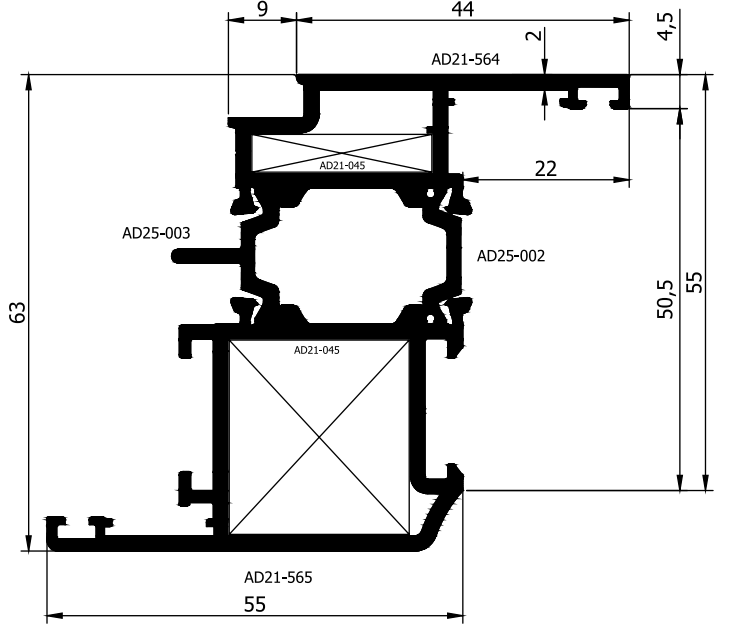

AD 21 - 052 ( 1,710 Kg/m )

Jx : 35,68 cm<sup>4</sup> Jy : 11,20 cm<sup>4</sup>

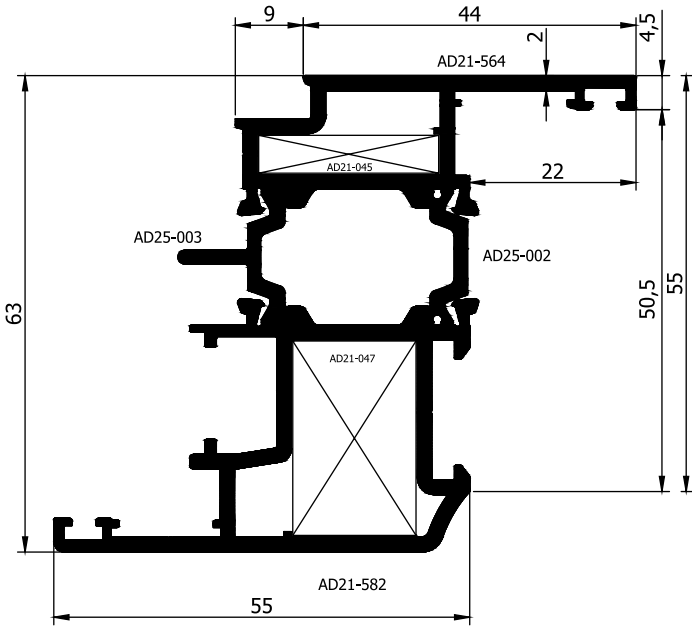

AD 21 - 062 ( 1,720 Kg/m )

Jx : 35,56 cm<sup>4</sup> Jy : 10,91 cm<sup>4</sup>

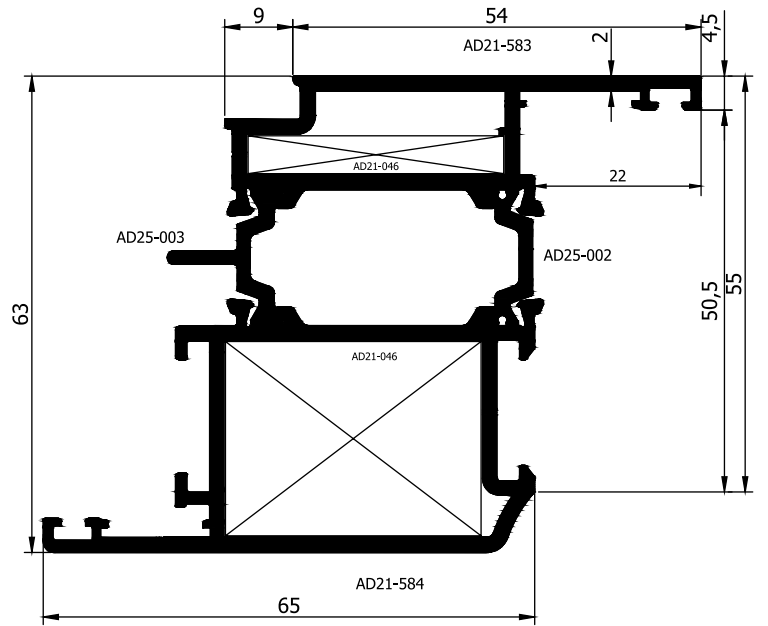

AD 21 - 063 ( 1,920 Kg/m )

Jx : 43,57 cm<sup>4</sup> Jy : 18,59 cm<sup>4</sup>

**Uyarı: Tablodaki profil ağırlıklarımız teorik olup; teslim anındaki tartımız geçerlidir.**

## AD 55 T YALITIMLI DOĞRAMA SİSTEMİ 2 mm KANAT PROFİLLERİ

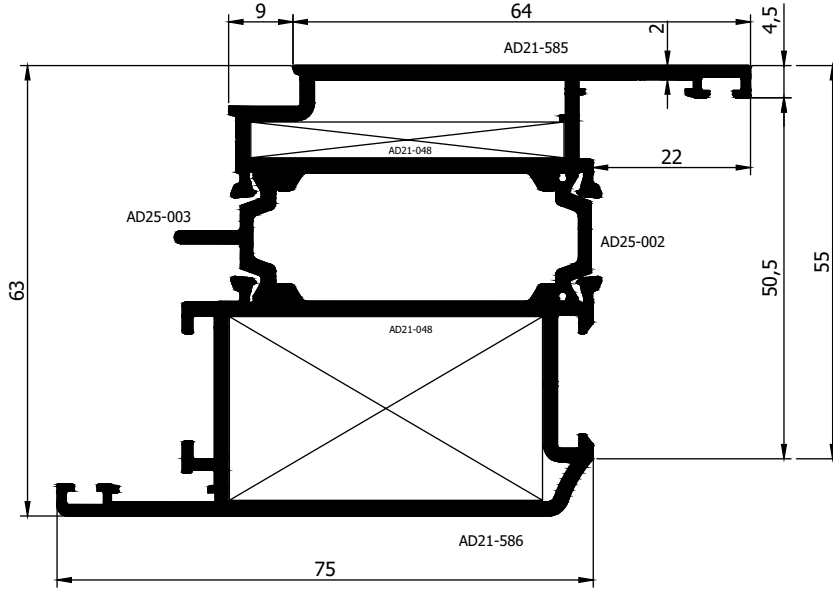

AD 21 - 064 ( 2,131 Kg/m )

Jx : 54,63 cm<sup>4</sup> Jy : 26,63 cm<sup>4</sup>

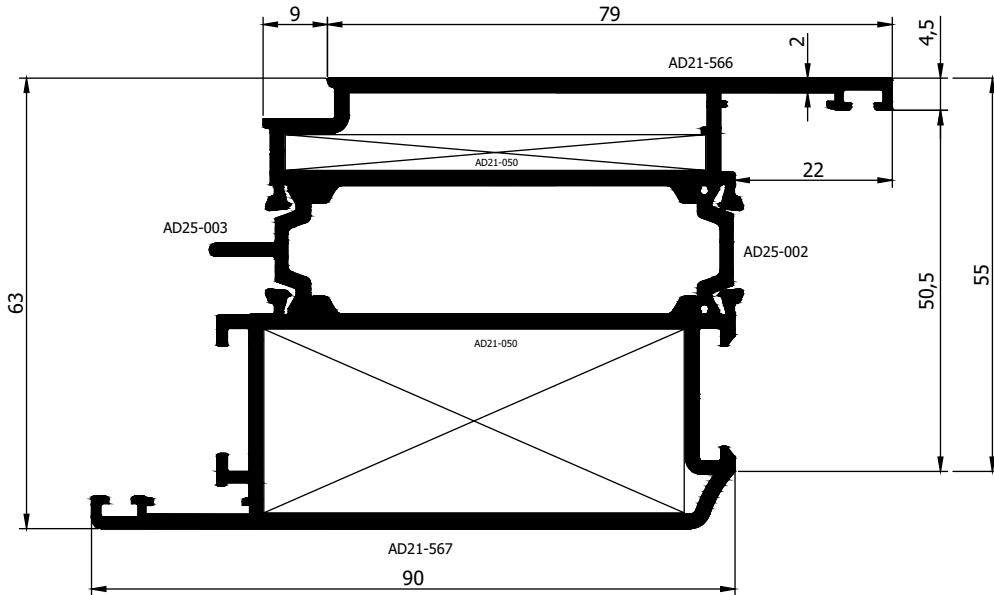

AD 21 - 053 ( 2,449 Kg/m )

Jx : 80,67 cm<sup>4</sup> Jy : 37,27 cm<sup>4</sup>

Uyarı: Tablodaki profil ağırlıklarımız teorik olup; teslim anındaki tartımız geçerlidir.

AD 55 T YALITIMLI DOĞRAMA SİSTEMİ  
2 mm KANAT PROFİLLERİ

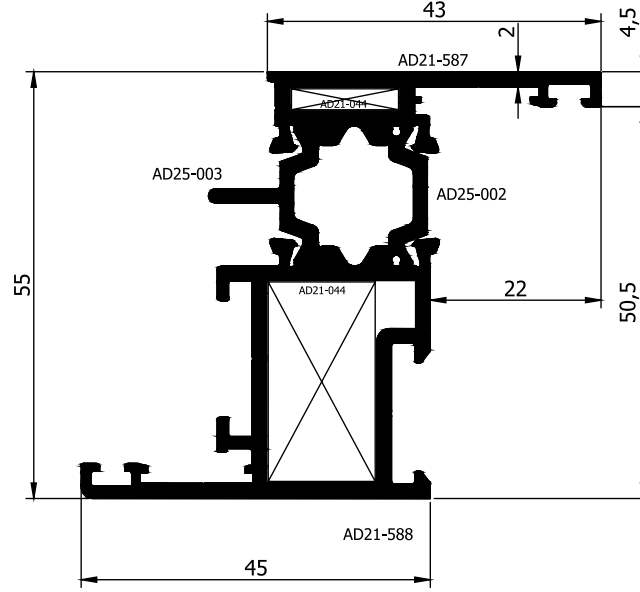

AD 21 - 065 ( 1,422 Kg/m )

Jx : 23,95 cm<sup>4</sup> Jy : 5,88 cm<sup>4</sup>

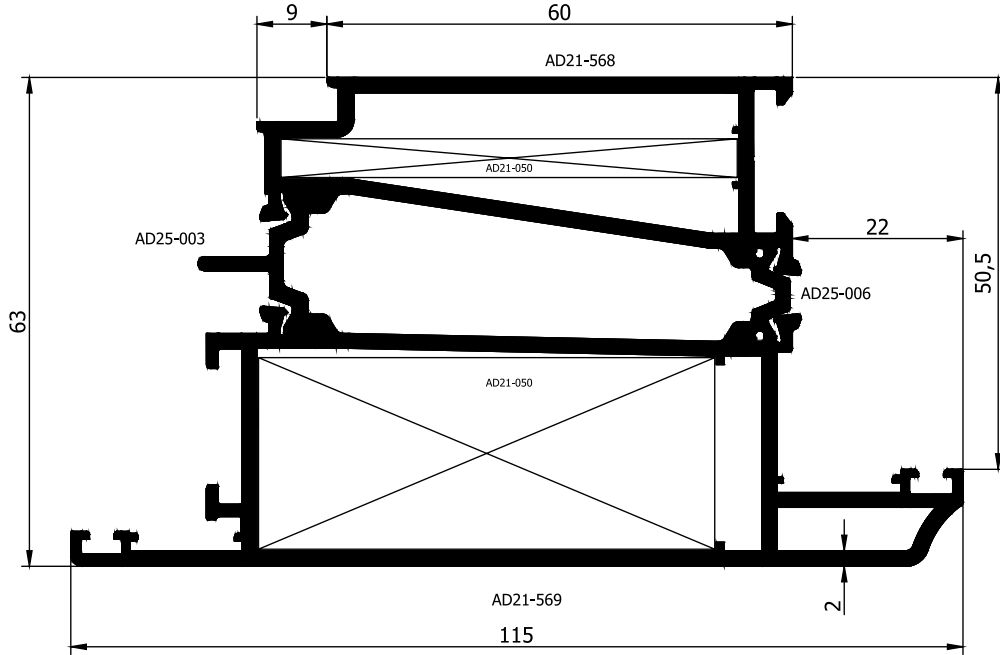

AD 21 - 054 ( 2,676 Kg/m )

Jx : 91,27 cm<sup>4</sup> Jy : 46,72 cm<sup>4</sup>

Uyarı: Tablodaki profil ağırlıklarımız teorik olup; teslim anındaki tartımız geçerlidir.

## AD 55 T YALITIMLI DOĞRAMA SİSTEMİ 2 mm ORTA KAYIT PROFİLLERİ

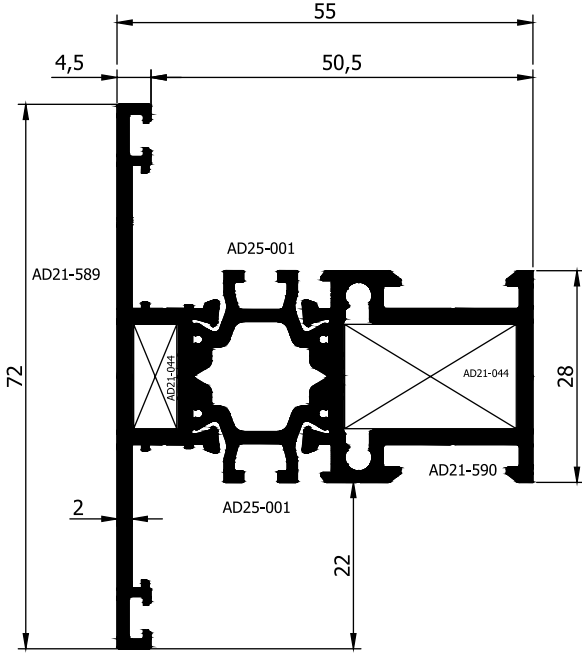

AD 21 - 066 ( 1,512 Kg/m )

Jx : 19,28 cm<sup>4</sup> Jy : 10,86 cm<sup>4</sup>

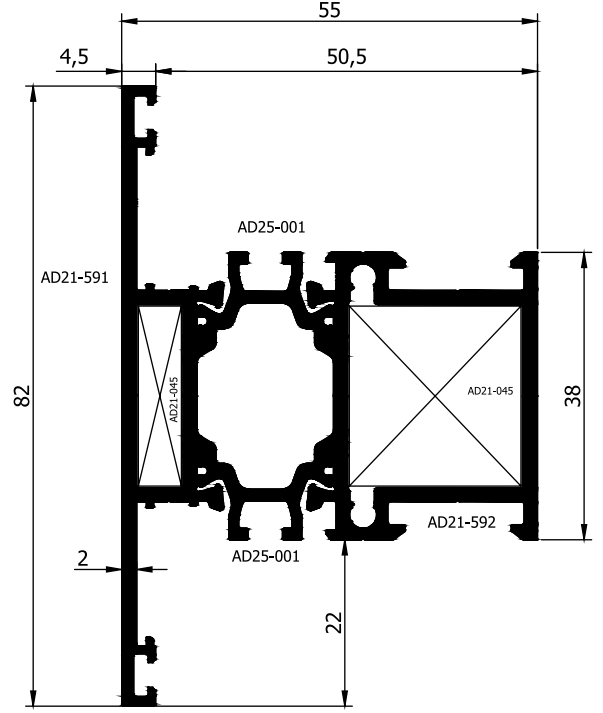

AD 21 - 067 ( 1,724 Kg/m )

Jx : 22,63 cm<sup>4</sup> Jy : 19,04 cm<sup>4</sup>

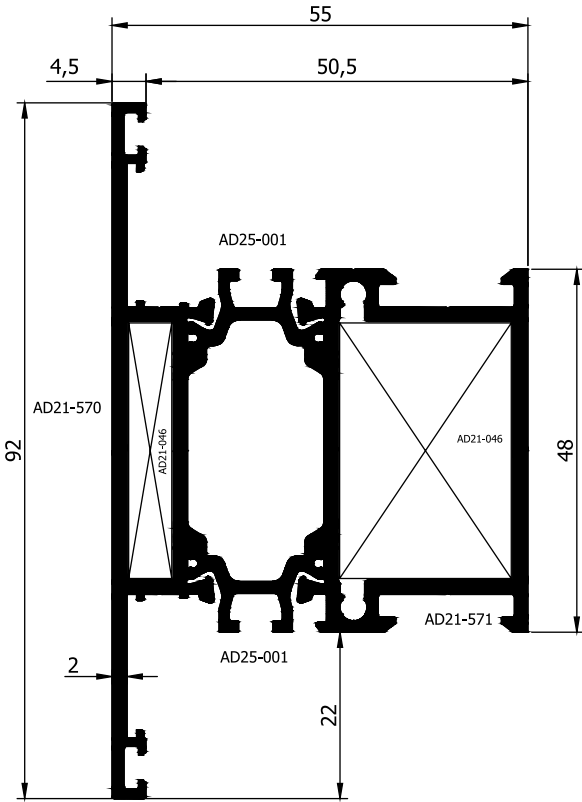

AD 21 - 055 ( 1,936 Kg/m )

Jx : 30,74 cm<sup>4</sup> Jy : 25,99 cm<sup>4</sup>

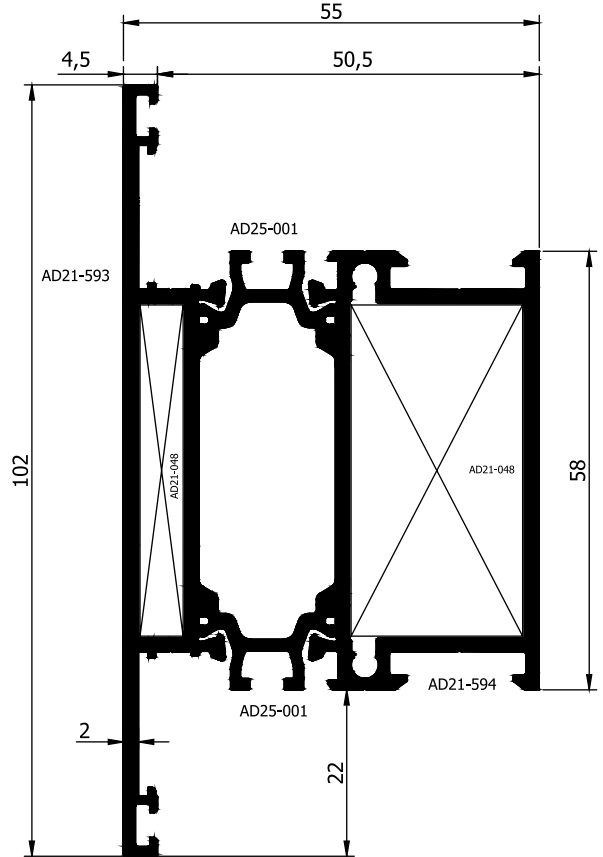

AD 21 - 068 ( 2,146 Kg/m )

Jx : 46,31 cm<sup>4</sup> Jy : 29,33 cm<sup>4</sup>

AD 55 T YALITIMLI DOĞRAMA SİSTEMİ  
2 mm ETEK PROFİLLERİ

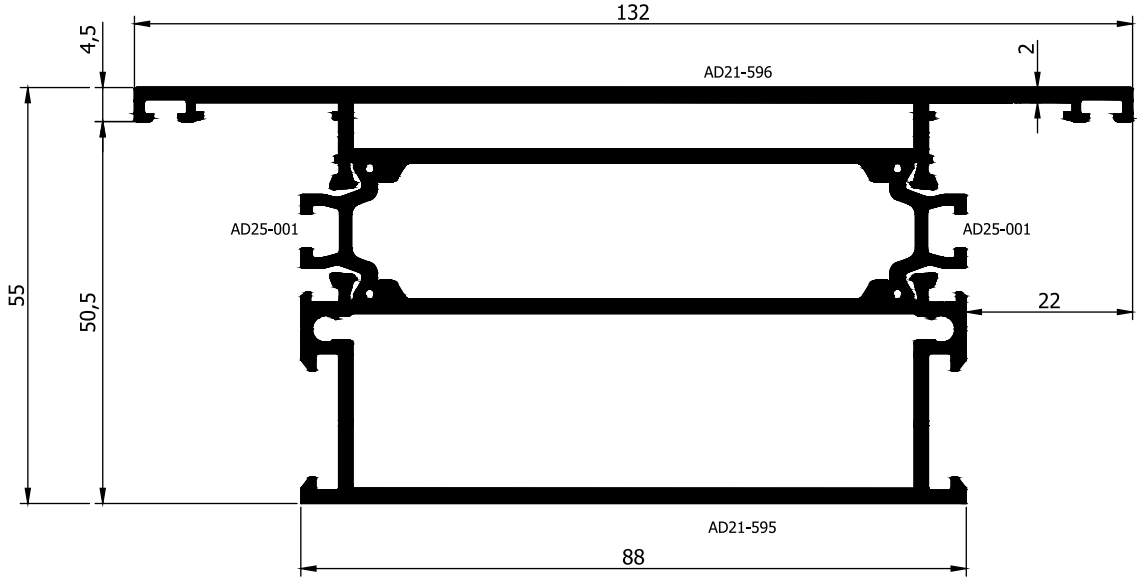

AD 21 - 069 ( 2,781 Kg/m )

Jx : 120,30 cm<sup>4</sup> Jy : 39,35 cm<sup>4</sup>

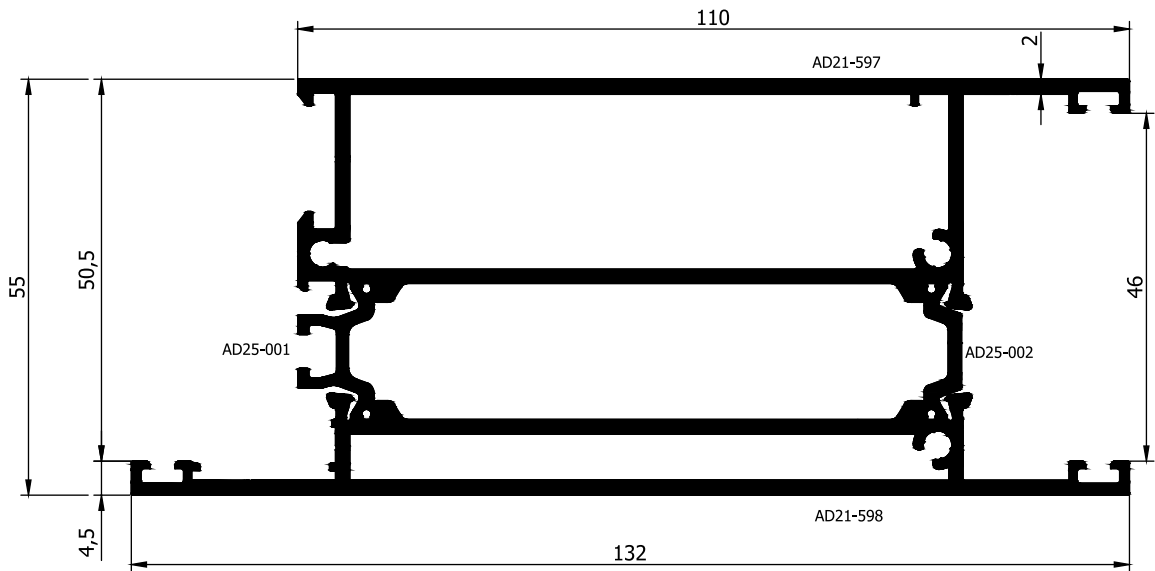

AD 21 - 070 ( 2,910 Kg/m )

Jx : 138,37 cm<sup>4</sup> Jy : 43,53 cm<sup>4</sup>

Uyarı: Tablodaki profil ağırlıklarımız teorik olup; teslim anındaki tartımız geçerlidir.

**AD 55 T YALITIMLI DOĞRAMA SİSTEMİ  
2 mm TAKVİYELİ ORTA KAYIT PROFİLLERİ**

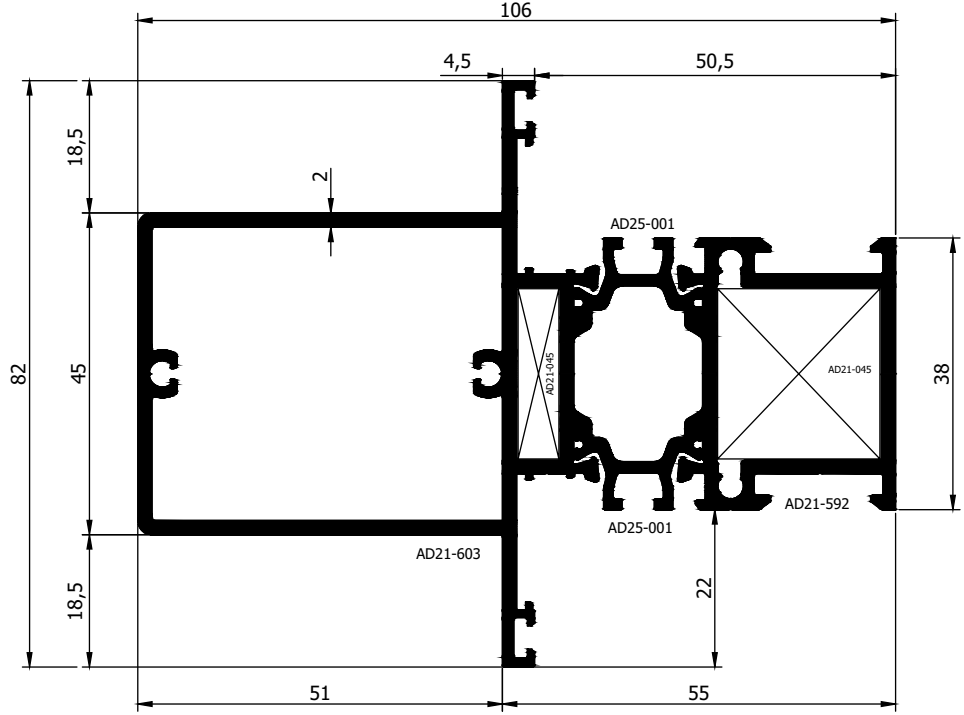

AD 21 - 071 ( 2,567 Kg/m )

Jx : 92,88 cm<sup>4</sup> Jy : 29,56 cm<sup>4</sup>

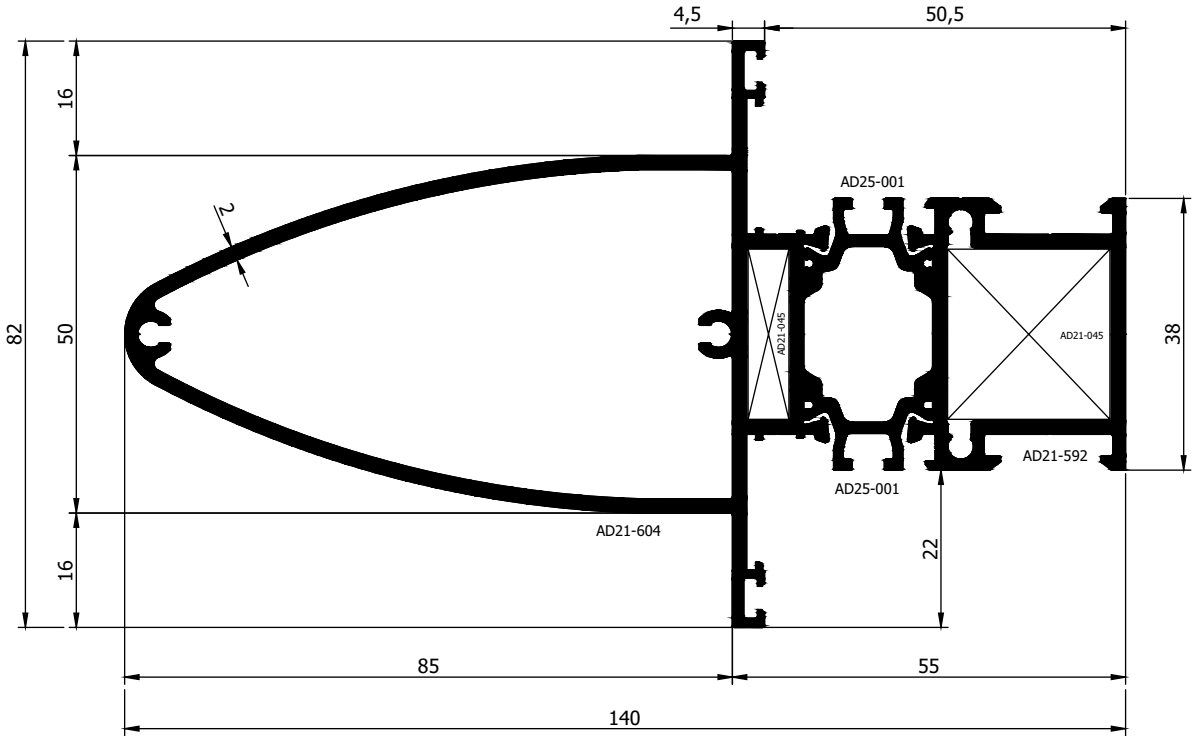

AD 21 - 072 ( 2,786 Kg/m )

Jx : 158,33 cm<sup>4</sup> Jy : 31,66 cm<sup>4</sup>

Uyarı: Tablodaki profil ağırlıklarımız teorik olup; teslim anındaki tartımız geçerlidir.

AD 55 T YALITIMLI DOĞRAMA SİSTEMİ  
2 mm HEMYÜZ KANAT PROFİLLERİ

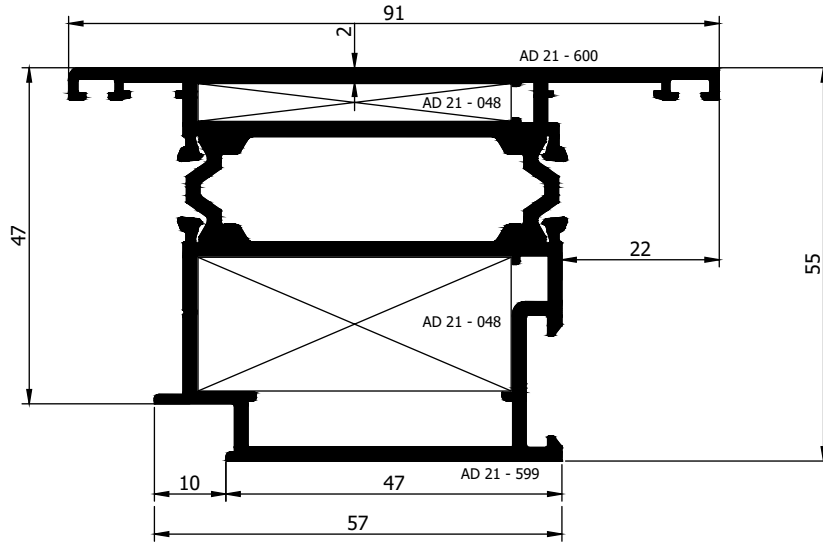

AD21-078 (2,020 Kg/m)

Jx : 37,54 cm<sup>4</sup>    Jy : 26,51 cm<sup>4</sup>

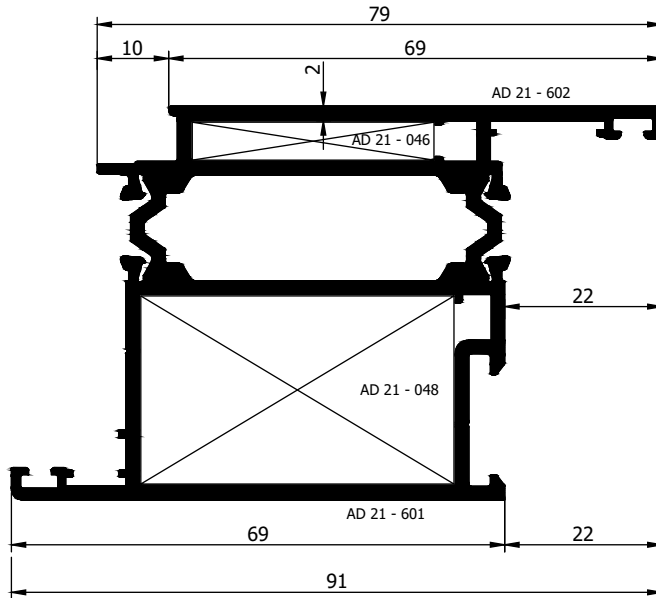

AD21-079 (1,980 Kg/m)

Jx : 42,42 cm<sup>4</sup>    Jy : 22,66 cm<sup>4</sup>

## AD 55 T YALITIMLI DOĞRAMA SİSTEMİ ADAPTÖR PROFİLLERİ

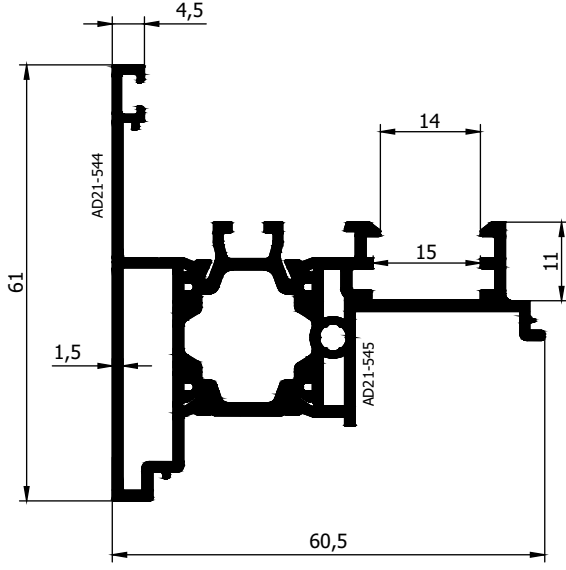

AD 21 - 025 ( 1,220 Kg/m )  
Jx : 13,88 cm<sup>4</sup> | Jy : 7,66 cm<sup>4</sup>

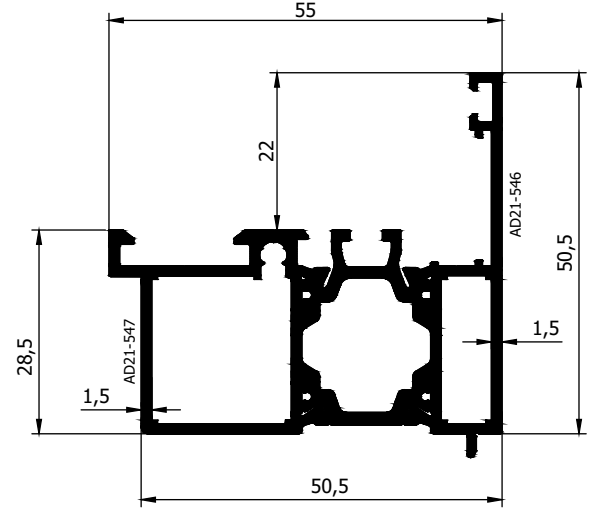

AD 21 - 026 ( 1,135 Kg/m )  
Jx : 12,97 cm<sup>4</sup> | Jy : 6,46 cm<sup>4</sup>

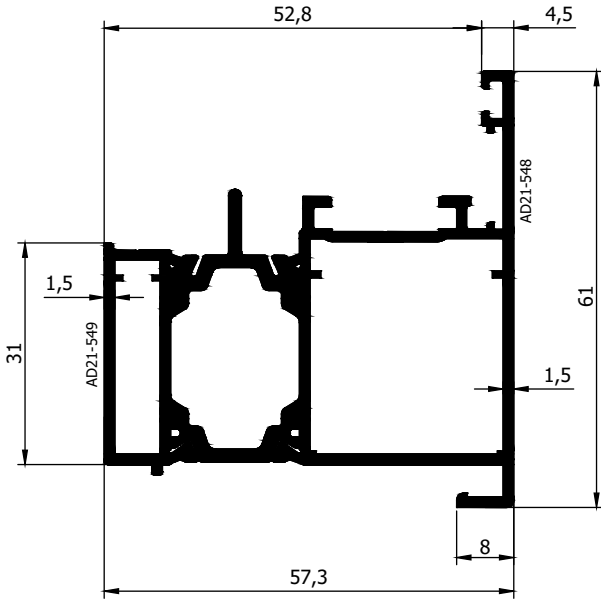

AD 21 - 027 ( 1,310 Kg/m )  
Jx : 21,11 cm<sup>4</sup> | Jy : 10,74 cm<sup>4</sup>

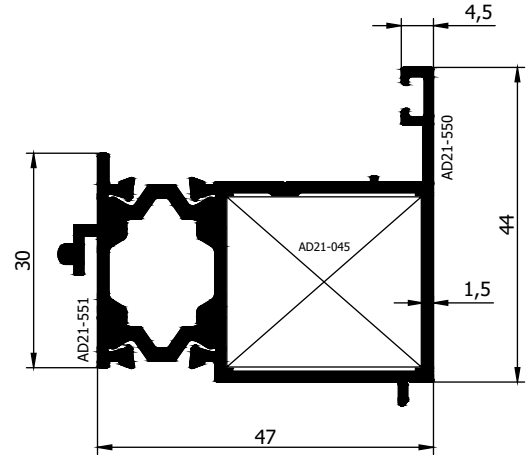

AD 21 - 028 ( 0,995 Kg/m )  
Jx : 11,92 cm<sup>4</sup> | Jy : 5,14 cm<sup>4</sup>

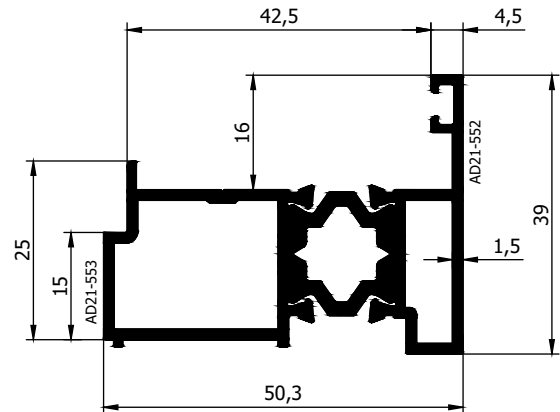

AD 21 - 029 ( 0,960 Kg/m )  
Jx : 9,45 m<sup>4</sup> | Jy : 2,95 cm<sup>4</sup>



## AD 55 T YALITIMLI DOĞRAMA SİSTEMİ ADAPTÖR ve KÖŞE PROFİLLERİ

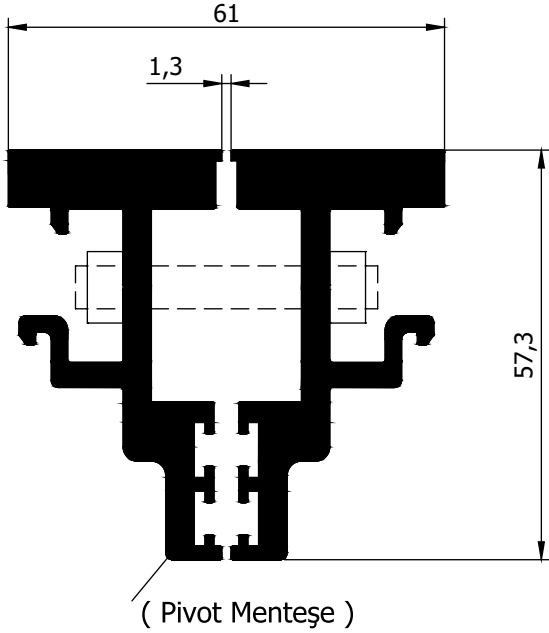

AD 21 - 049 ( 1,575 Kg/m )

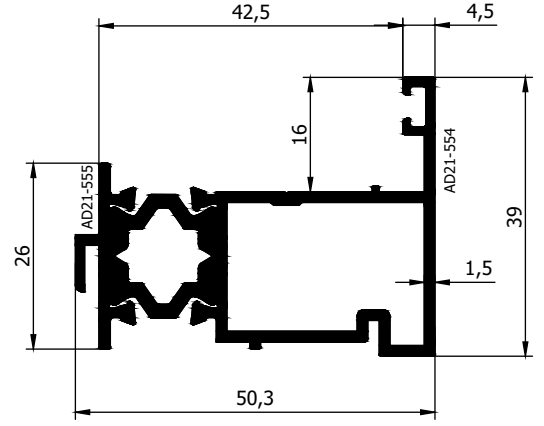

AD 21 - 030 ( 0,930 Kg/m )

Jx : 10,88 m<sup>4</sup> | Jy : 3,00 cm<sup>4</sup>

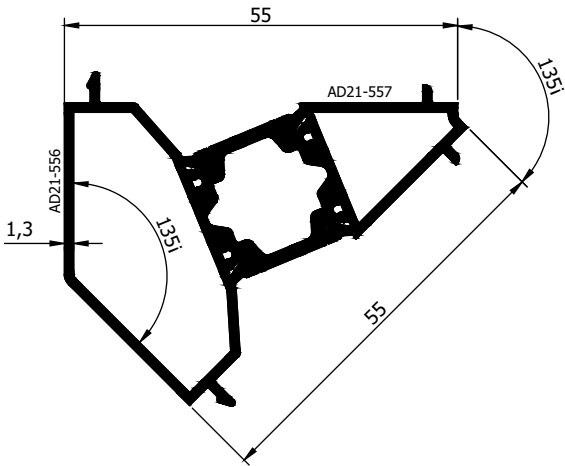

AD 21 - 031 ( 0,900 Kg/m )

Jx : 8,97 cm<sup>4</sup> | Jy : 4,14 cm<sup>4</sup>

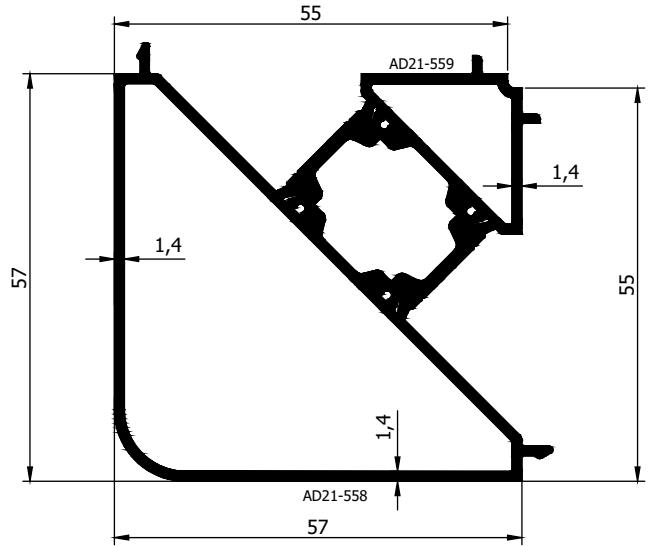

AD 21 - 032 ( 1,302 Kg/m )

Jx : 18,26 cm<sup>4</sup> | Jy : 18,24 cm<sup>4</sup>

## AD 55 T YALITIMLI DOĞRAMA SİSTEMİ YARDIMCI PROFİLLER

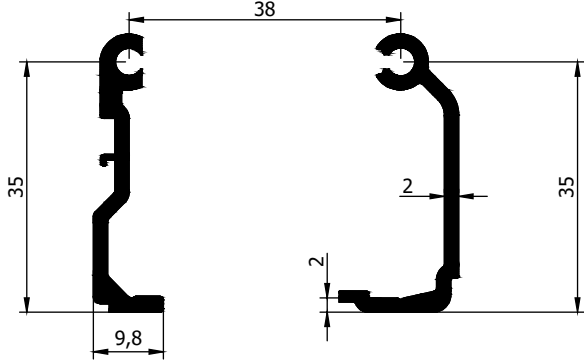

AD 21 - 042 ( 0,327 Kg/m )    AD 21 - 043 ( 0,347 Kg/m )

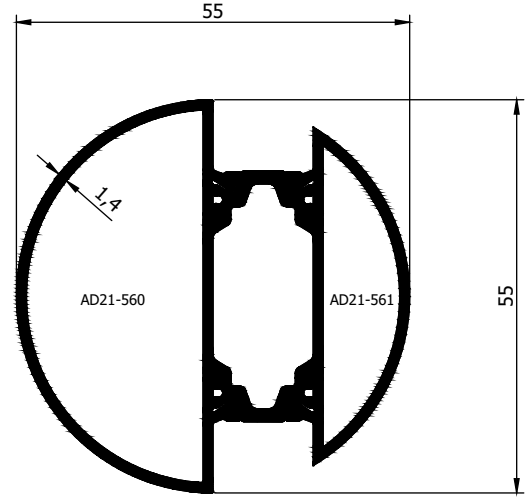

AD 21 - 039 ( 1,132 Kg/m )  
Jx : 11,19 cm<sup>4</sup> | Jy : 9,99 cm<sup>4</sup>

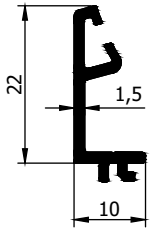

AD 21 - 040 ( 0,179 Kg/m )

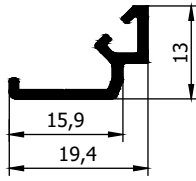

AD 21 - 041 ( 0,140 Kg/m )

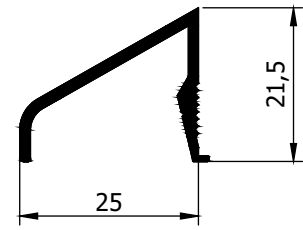

AD 20 - 037 ( 0,228 Kg/m )

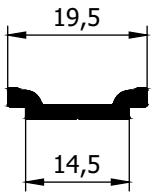

AD 20 - 038 ( 0,130 Kg/m )

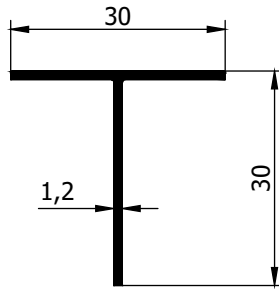

AD 02 - 004 ( 0,192 Kg/m )

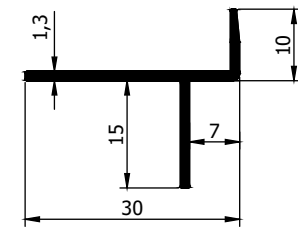

AD 20 - 035 ( 0,186 Kg/m )

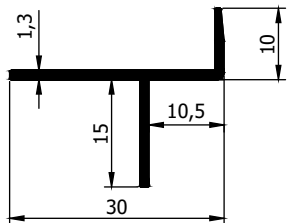

AD 20 - 036 ( 0,186 Kg/m )

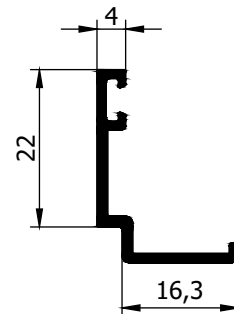

AD 20 - 040 ( 0,200 Kg/m )

Uyarı: Tablodaki profil ağırlıklarımız teorik olup; teslim anındaki tartımız geçerlidir.

## AD 55 T YALITIMLI DOĞRAMA SİSTEMİ ORTA KAYIT BAĞLANTI PROFİLLERİ

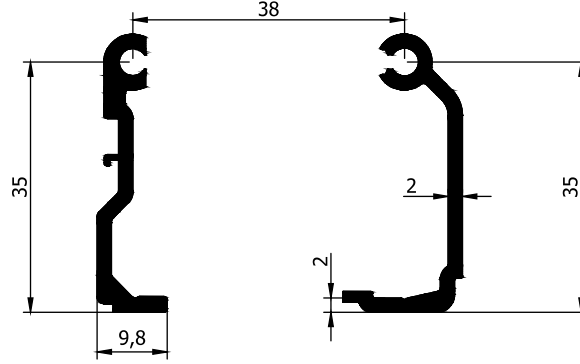

AD 21 - 042 ( 0,327 Kg/m )

AD 21 - 043 ( 0,347 Kg/m )

### AD 21 - 042 ve AD 21 - 043 KESİM ÖLÇÜLERİ

Kullanılan Prf.	Kesim Ölçüsü
AD 21 - 015	13,7 MM
AD 21 - 016	23,7 MM
AD 21 - 017	33,7 MM
AD 21 - 018	43,7 MM
AD 21 - 019	73,7 MM
AD 21 - 020	73,7 MM
AD 21 - 023	23,7 MM
AD 21 - 024	23,7 MM
AD 21 - 066	13,7 MM
AD 21 - 067	23,7 MM
AD 21 - 055	33,7 MM
AD 21 - 068	43,7 MM
AD 21 - 069	73,7 MM
AD 21 - 070	73,7 MM
AD 21 - 071	23,7 MM
AD 21 - 072	23,7 MM

## AD 55 T YALITIMLI DOĞRAMA SİSTEMİ ORTA KAYIT BAĞLANTI PROFİLLERİ

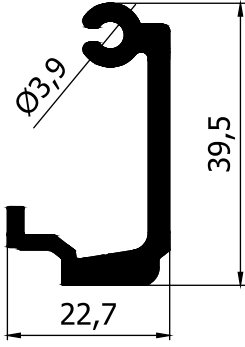

ORTA KAYIT BAĞLANTI PROFİLİ  
AD21-074 (0,623 Kg/m)

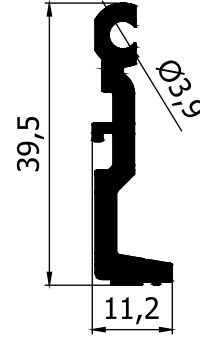

ORTA KAYIT BAĞLANTI PROFİLİ  
AD21-075 (0,444 Kg/m)

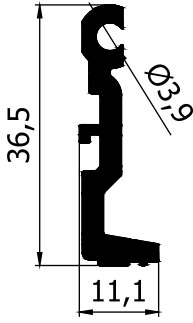

ORTA KAYIT BAĞLANTI PROFİLİ  
AD21-076 (0,420 Kg/m)

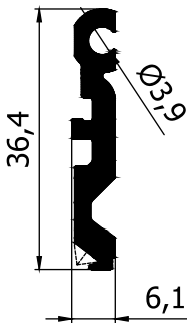

ORTA KAYIT BAĞLANTI PROFİLİ (SETSKURLU)  
AD21-077 (0,388 Kg/m)

### AD21-074, AD21-075, AD21-076, AD21-077 PROFİLLERİNİN KESİM ÖLÇÜLERİ

Kullanılan Prf.	Kesim Ölçüsü
AD 21 - 015	13,7 MM
AD 21 - 016	23,7 MM
AD 21 - 017	33,7 MM
AD 21 - 018	43,7 MM
AD 21 - 019	73,7 MM
AD 21 - 020	73,7 MM
AD 21 - 023	23,7 MM
AD 21 - 024	23,7 MM
AD 21 - 066	13,7 MM
AD 21 - 067	23,7 MM
AD 21 - 055	33,7 MM
AD 21 - 068	43,7 MM
AD 21 - 069	73,7 MM
AD 21 - 070	73,7 MM
AD 21 - 071	23,7 MM
AD 21 - 072	23,7 MM

Uyarı: Tablodaki profil ağırlıklarımız teorik olup; teslim anındaki tartımız geçerlidir.

## AD 55 T YALITIMLI DOĞRAMA SİSTEMİ KÖŞE TAKOZU PROFİLLERİ

AD 21 - 044 ( 3,030 Kg/m )

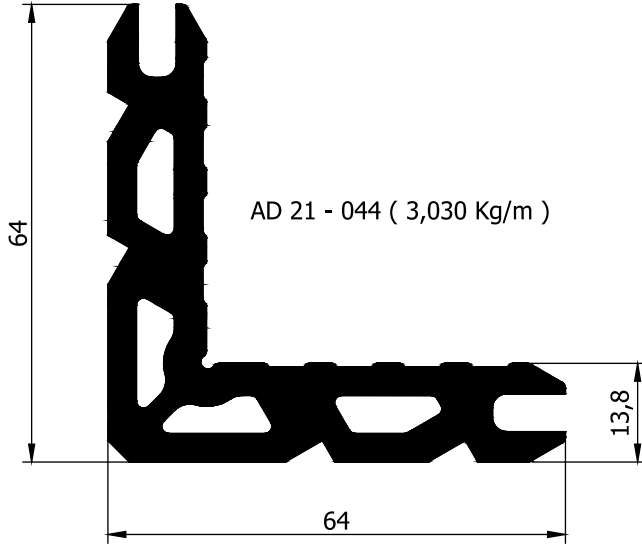

Kullanılan Prf.	Dış Bölüm Kesim Ölçüsü	İç Bölüm Kesim Ölçüsü
AD 21 - 001 AD 21 - 005 AD 21 - 015	6,5 mm	23,5 mm
AD 21 - 007	5,9 mm	26,5 mm
AD 21 - 013	3,5 mm	26,5 mm
AD 21 - 056 AD 21 - 059 AD 21 - 066	5,7 mm	22,7 mm
AD 21 - 061	5 mm	25,7 mm
AD 21 - 065	2,7 mm	25,7 mm

AD 21 - 045 ( 3,566 Kg/m )

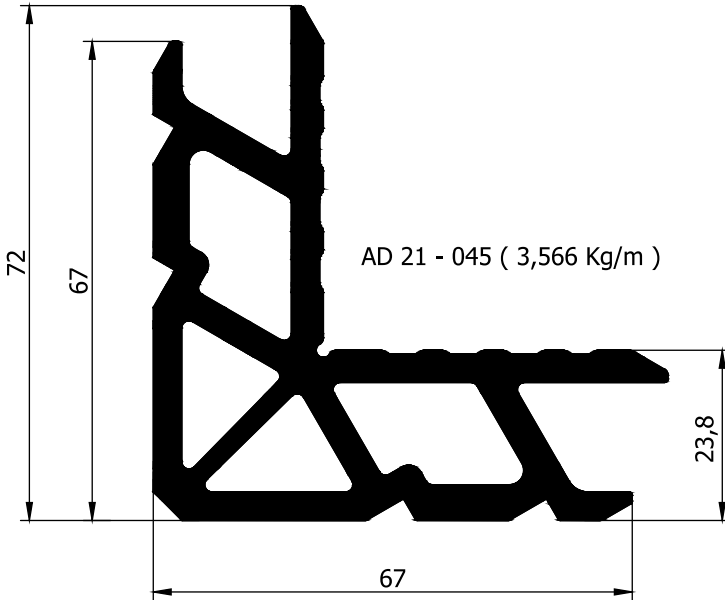

Kullanılan Prf.	Dış Bölüm Kesim Ölçüsü	İç Bölüm Kesim Ölçüsü
AD 21 - 002 AD 21 - 006 AD 21 - 016 AD 21 - 023 AD 21 - 024	6,5 mm	23,5 mm
AD 21 - 008 AD 21 - 009	5,8 mm 5,9 mm	26,5 mm Farklı
AD 21 - 027		26,5 mm
AD 21 - 028		27 mm
AD 21 - 057 AD 21 - 060 AD 21 - 067 AD 21 - 071 AD 21 - 072	5,7 mm	22,7 mm
AD 21 - 052 AD 21 - 062	5 mm	25,7 mm FARKLI

Uyarı: Tablodaki profil ağırlıklarımız teorik olup; teslim anındaki tartımız geçerlidir.

## AD 55 T YALITIMLI DOĞRAMA SİSTEMİ KÖŞE TAKOZU PROFİLLERİ

AD 21 - 046 ( 4,157 Kg/m )

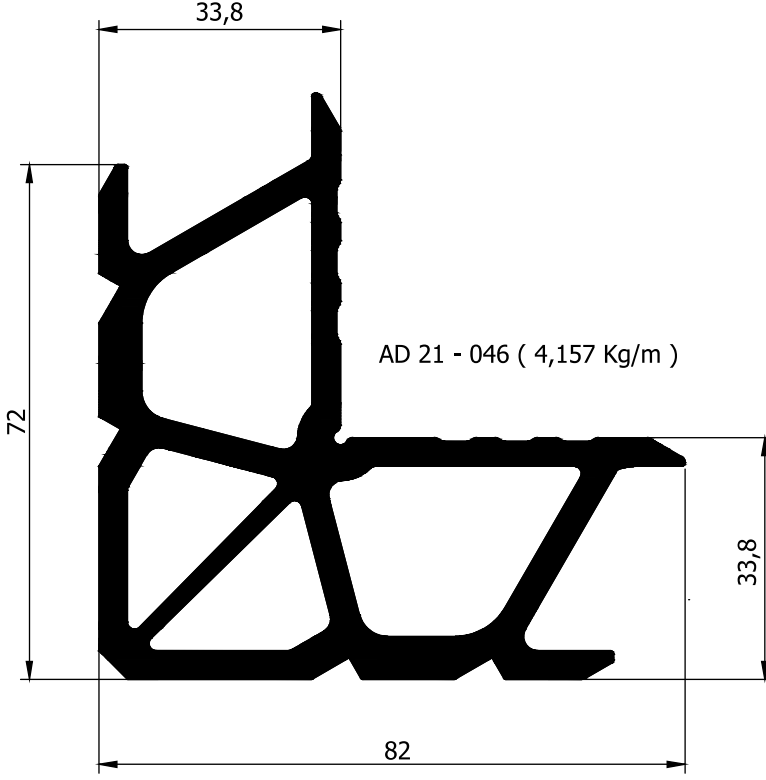

Kullanılan Prf.	Dış Bölüm Kesim Ölçüsü	İç Bölüm Kesim Ölçüsü
AD 21 - 003 AD 21 - 017	6,5 mm	23,5 mm
AD 21 - 010	5,8 mm	26,5 mm
AD 21 - 051 AD 21 - 055	5,7 mm	22,7 mm
AD 21 - 063	5 mm	25,7 mm
AD 21 - 079	5,3 mm	FARKLI
AD 21 - 088	21,5 mm	23,5 mm
AD 21 - 089	25,5 mm	FARKLI

AD 21 - 047 ( 3,220 Kg/m )

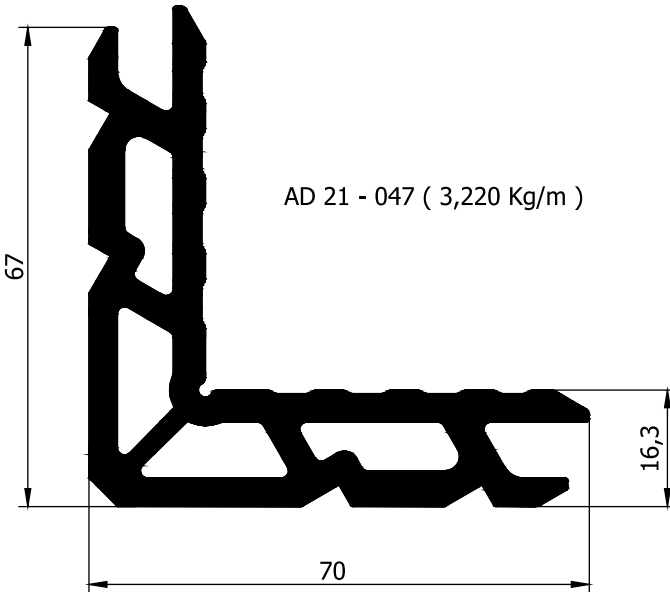

Kullanılan Prf.	Kesim Ölçüsü
AD 21 - 009	26,5 mm
AD 21 - 062	25,7 mm

Uyarı: Tablodaki profil ağırlıklarımız teorik olup; teslim anındaki tartımız geçerlidir.

## AD 55 T YALITIMLI DOĞRAMA SİSTEMİ KÖŞE TAKOZU PROFİLLERİ

AD 21 - 048 ( 5,307 Kg/m )

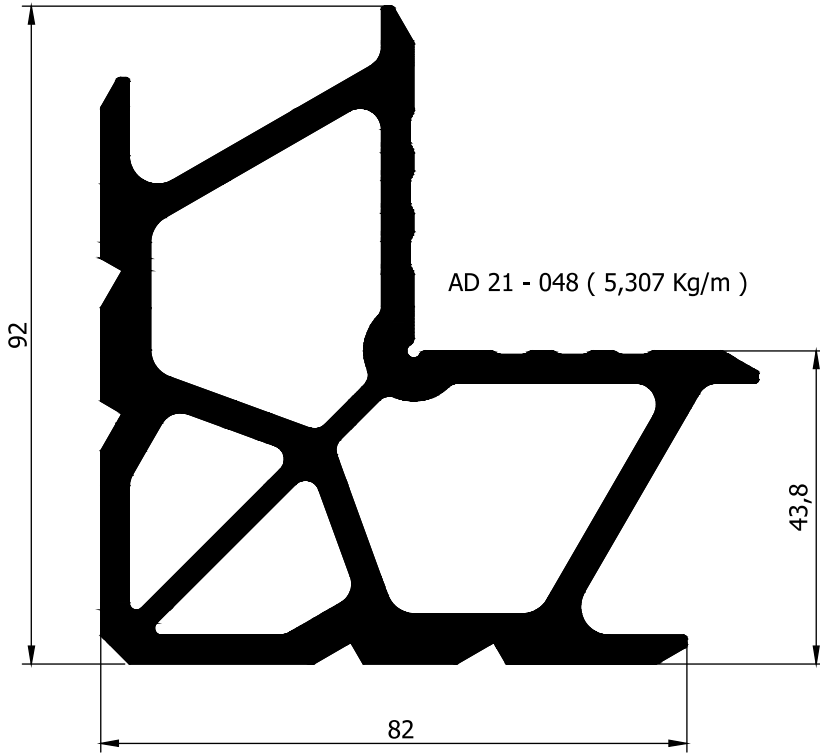

Kullanılan Prf.	Dış Bölüm Kesim Ölçüsü	İç Bölüm Kesim Ölçüsü
AD 21 - 004 AD 21 - 018	6,5 mm	23,5 mm
AD 21 - 021	6 mm	19 mm
AD 21 - 022	6 mm	27 mm
AD 21 - 011	5,8 mm	26,5 mm
AD 21 - 058 AD 21 - 068	5,7 mm	22,7 mm
AD 21 - 064	5 mm	25,7 mm
AD 21 - 073	FARKLI	26,5 mm
AD 21 - 078	5,3 mm	18,7 mm
AD 21 - 079	FARKLI	26,3 mm

AD 21 - 050 ( 6,366 Kg/m )

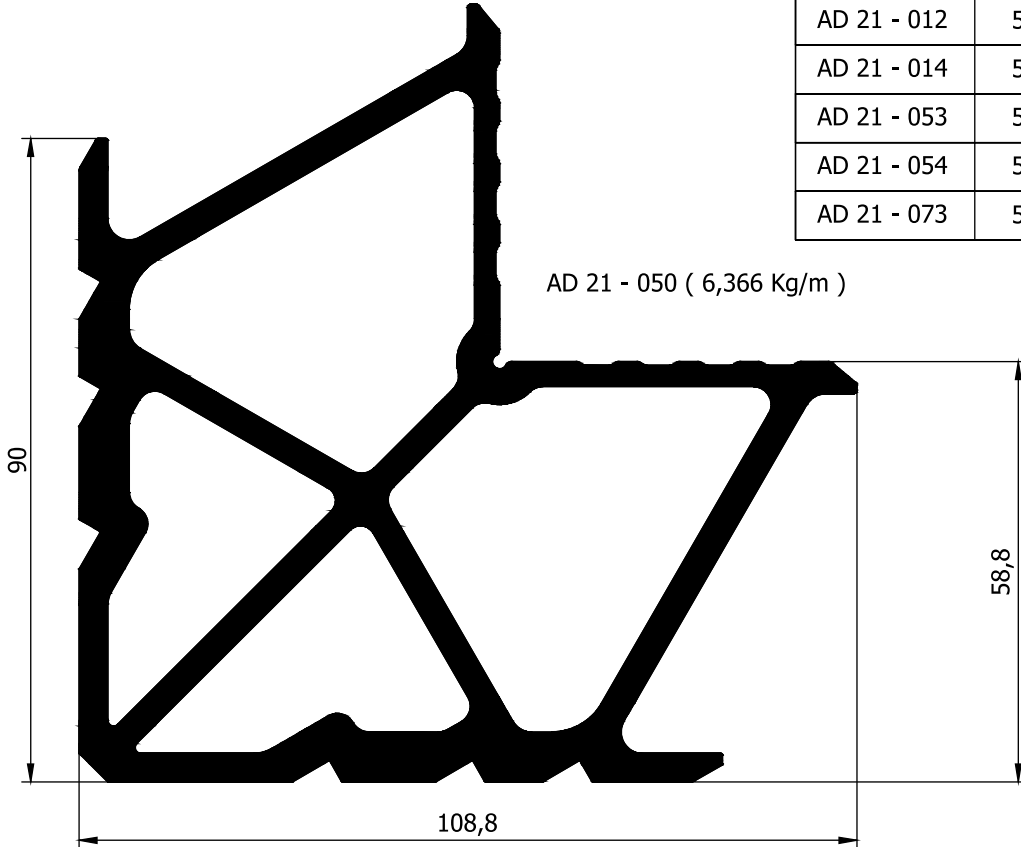

Kullanılan Prf.	Dış Bölüm Kesim Ölçüsü	İç Bölüm Kesim Ölçüsü
AD 21 - 012	5,8 mm	26,5 mm
AD 21 - 014	5,8 mm	25,5 mm
AD 21 - 053	5 mm	25,7 mm
AD 21 - 054	5 mm	24,7 mm
AD 21 - 073	5,8 mm	FARKLI

Uyarı: Tablodaki profil ağırlıklarımız teorik olup; teslim anındaki tartımız geçerlidir.

## AD 55 T YALITIMLI DOĞRAMA SİSTEMİ KÖŞE TAKOZU PROFİLLERİ

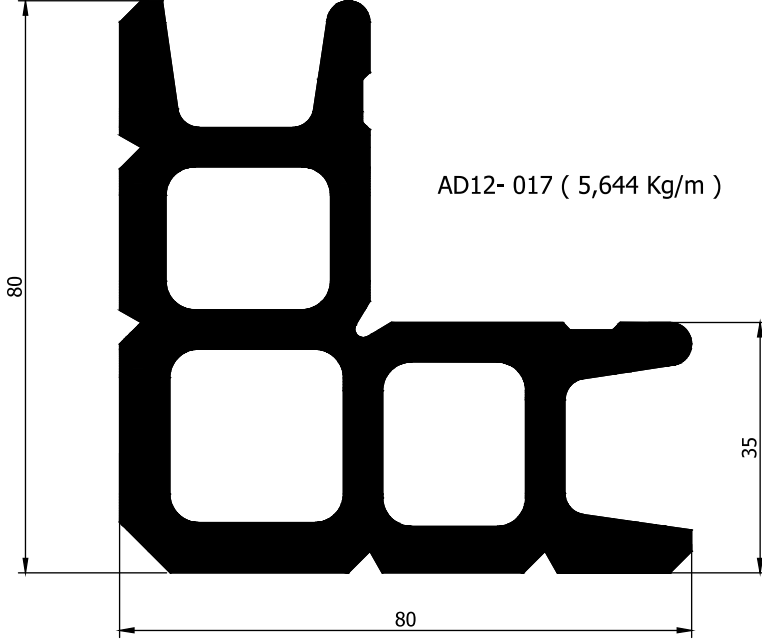

AD12- 017 ( 5,644 Kg/m )

Kullanılan Prf.	Kesim Ölçüsü
AD21-089	5,9 mm

**Uyarı: Tablodaki profil ağırlıklarımız teorik olup; teslim anındaki tartımız geçerlidir.**



AD 55 T YALITIMLI DOĞRAMA SİSTEMİ  
VİDALI KÖŞE TAKOZU PROFİLLERİ

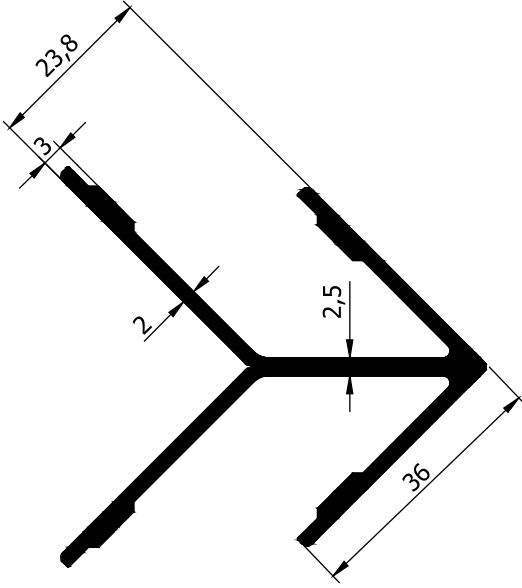

AD 20 - 048 ( 1,079 Kg/m )

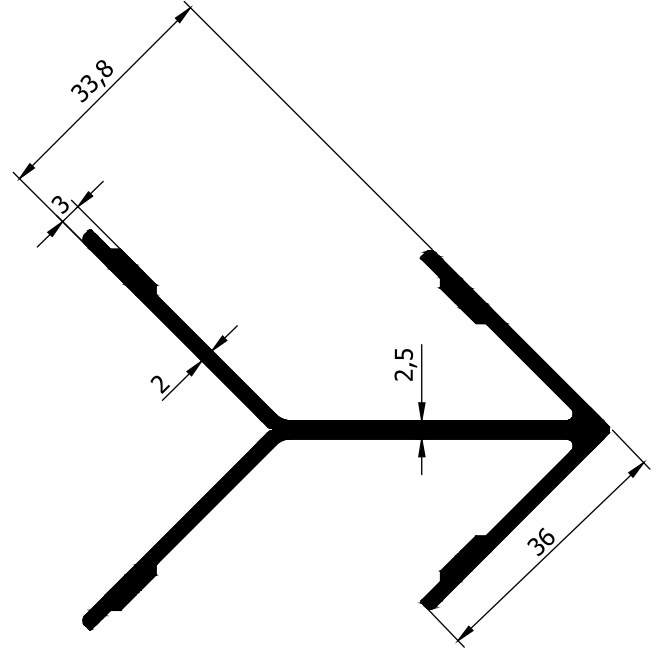

AD 20 - 049 ( 1,176 Kg/m )

Kullanılan Prf.	Dış Bölüm Kesim Ölçüsü	İç Bölüm Kesim Ölçüsü
AD 21 - 002 AD 21 - 006 AD 21 - 016 AD 21 - 023 AD 21 - 024	6,5 mm	23,5 mm
AD 21 - 008 AD 21 - 009	5,8 mm 5,9 mm	26,5 mm Farklı
AD 21 - 027		26,5 mm
AD 21 - 028		27 mm
AD 21 - 057 AD 21 - 060 AD 21 - 067 AD 21 - 071 AD 21 - 072	5,7 mm	22,7 mm
AD 21 - 052 AD 21 - 062	5 mm	25,7 mm FARKLI

Kullanılan Prf.	Dış Bölüm Kesim Ölçüsü	İç Bölüm Kesim Ölçüsü
AD 21 - 003 AD 21 - 017	6,5 mm	23,5 mm
AD 21 - 010	5,8 mm	26,5 mm
AD 21 - 051 AD 21 - 055	5,7 mm	22,7 mm
AD 21 - 063	5 mm	25,7 mm
AD 21 - 079	5,3 mm	FARKLI
AD 21 - 088	21,5 mm	23,5 mm
AD 21 - 089	25,5 mm	FARKLI

Uyarı: Tablodaki profil ağırlıklarımız teorik olup; teslim anındaki tartımız geçerlidir.

## AD 55 T YALITIMLI DOĞRAMA SİSTEMİ VİDALI KÖŞE TAKOZU PROFİLLERİ

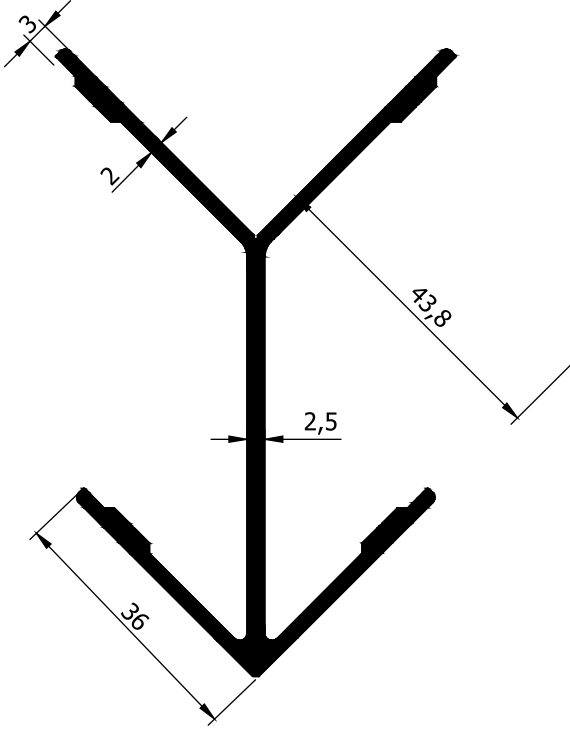

AD 20 - 050 ( 1,271 Kg/m )

Kullanılan Prf.	Dış Bölüm Kesim Ölçüsü	İç Bölüm Kesim Ölçüsü
AD 21 - 004 AD 21 - 018	6,5 mm	23,5 mm
AD 21 - 021	6 mm	19 mm
AD 21 - 022	6 mm	27 mm
AD 21 - 011	5,8 mm	26,5 mm
AD 21 - 058 AD 21 - 068	5,7 mm	22,7 mm
AD 21 - 064	5 mm	25,7 mm
AD 21 - 073	FARKLI	26,5 mm
AD 21 - 078	5,3 mm	18,7 mm
AD 21 - 079	FARKLI	26,3 mm

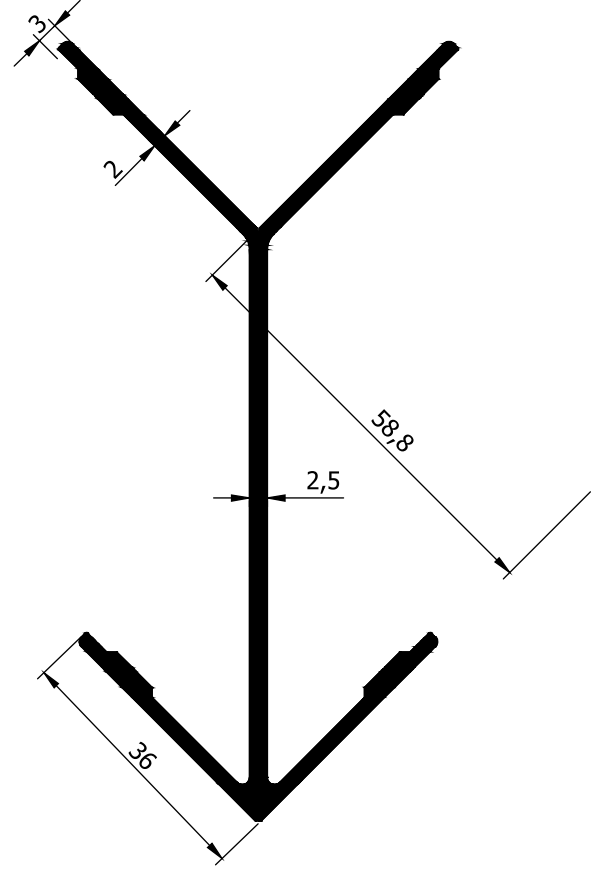

AD 20 - 051 ( 1,415 Kg/m )

Kullanılan Prf.	Dış Bölüm Kesim Ölçüsü	İç Bölüm Kesim Ölçüsü
AD 21 - 012	5,8 mm	26,5 mm
AD 21 - 014	5,8 mm	25,5 mm
AD 21 - 053	5 mm	25,7 mm
AD 21 - 054	5 mm	24,7 mm
AD 21 - 073	5,8 mm	FARKLI

Uyarı: Tablodaki profil ağırlıklarımız teorik olup; teslim anındaki tartımız geçerlidir.

## AD 55 T YALITIMLI DOĞRAMA SİSTEMİ VİDALI KÖŞE TAKOZU PROFİLLERİ

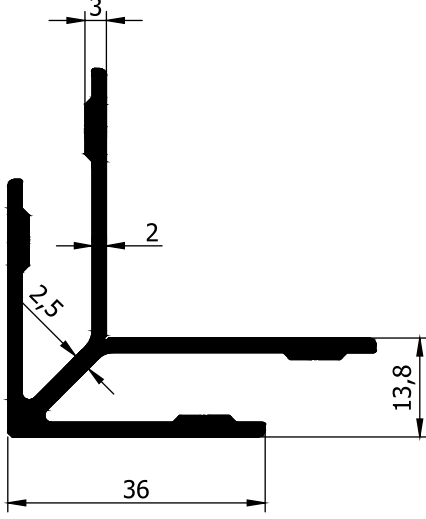

AD 20 - 052 ( 0,984 Kg/m )

Kullanılan Prf.	Dış Bölüm Kesim Ölçüsü	İç Bölüm Kesim Ölçüsü
AD 21 - 001 AD 21 - 005 AD 21 - 015	6,5 mm	23,5 mm
AD 21 - 007	5,9 mm	26,5 mm
AD 21 - 013	3,5 mm	26,5 mm
AD 21 - 056 AD 21 - 059 AD 21 - 066	5,7 mm	22,7 mm
AD 21 - 061	5 mm	25,7 mm
AD 21 - 065	2,7 mm	25,7 mm

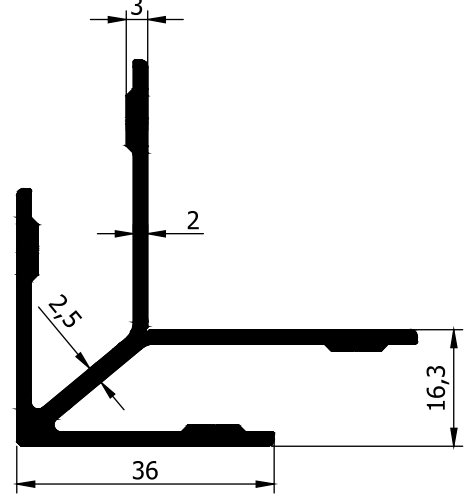

AD 20 - 053 ( 1,016 Kg/m )

Kullanılan Prf.	Kesim Ölçüsü
AD 21 - 009	26.5 mm
AD 21 - 062	25,7 mm

Uyarı: Tablodaki profil ağırlıklarımız teorik olup; teslim anındaki tartımız geçerlidir.

**AD 55 T YALITIMLI DOĞRAMA SİSTEMİ  
MENTEŞE PROFİLLERİ**

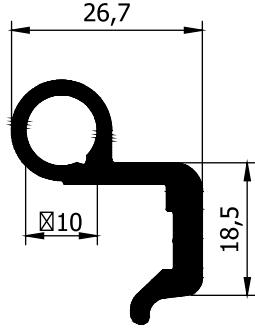

**KASA MENTEŞE**  
AD21-080 (0,575 Kg/m)

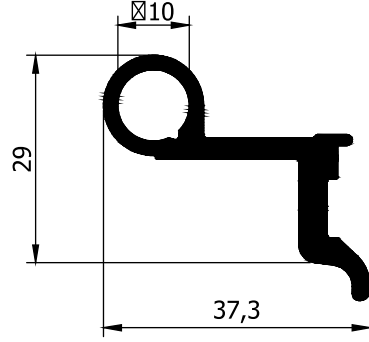

**KANAT MENTEŞE**  
AD21-081 (0,640 Kg/m)

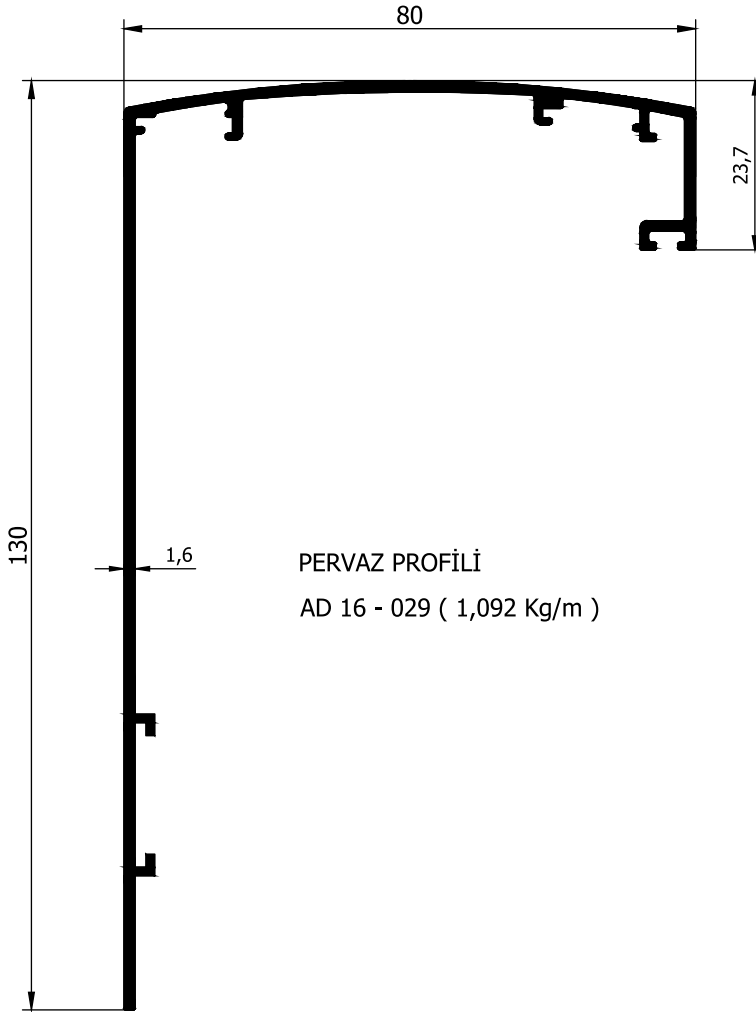

**PERVAZ PROFİLİ**  
AD 16 - 029 ( 1,092 Kg/m )

## AD 55 T YALITIMLI DOĞRAMA SİSTEMİ ÇİTA PROFİLLERİ VE CAM KOMBİNASYONU

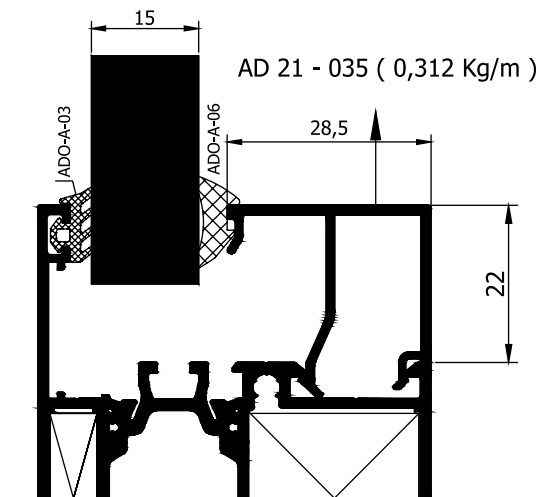
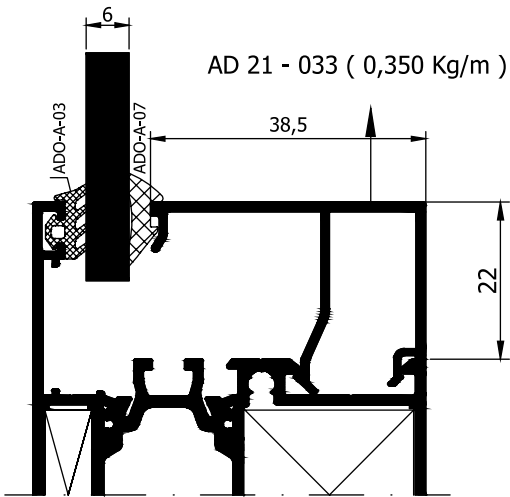
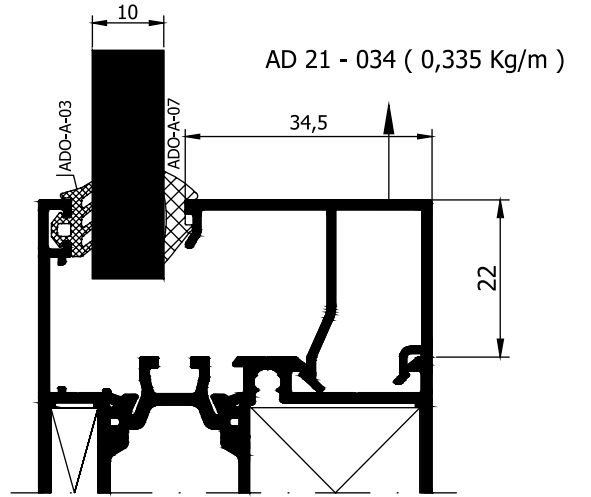
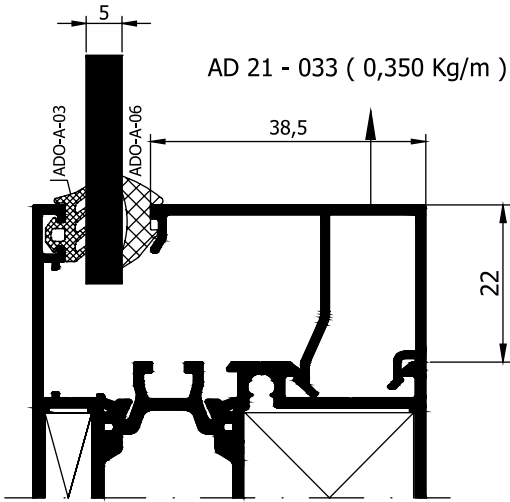
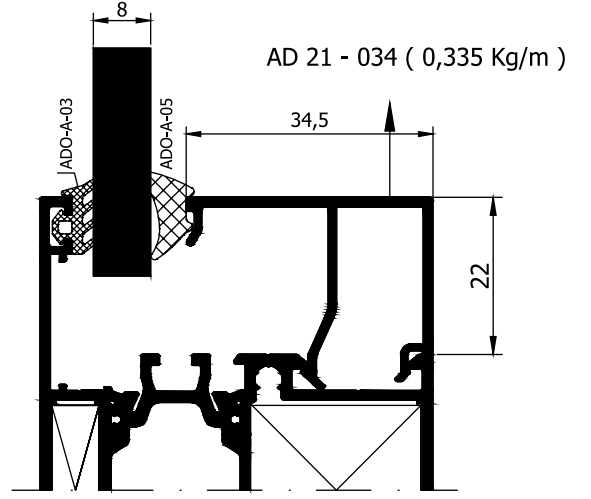
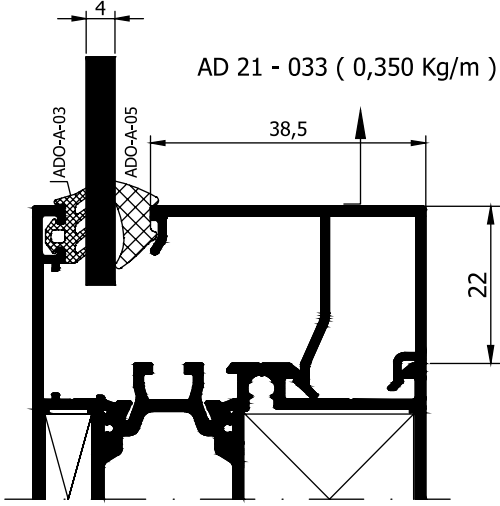

Uyarı: Tablodaki profil ağırlıklarımız teorik olup; teslim anındaki tartımız geçerlidir.

## AD 55 T YALITIMLI DOĞRAMA SİSTEMİ ÇİTA PROFİLLERİ VE CAM KOMBİNASYONU

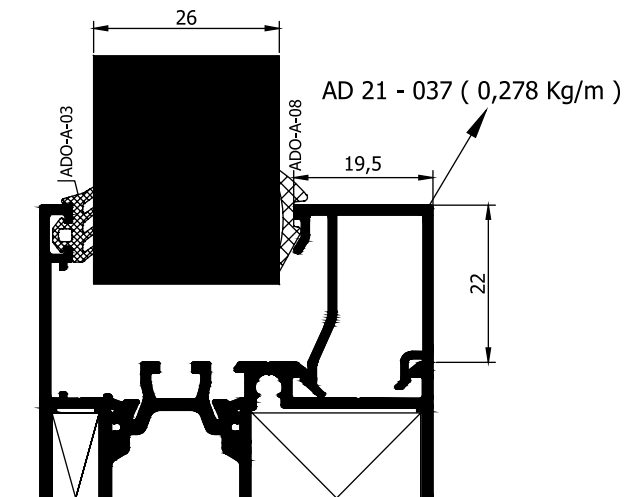
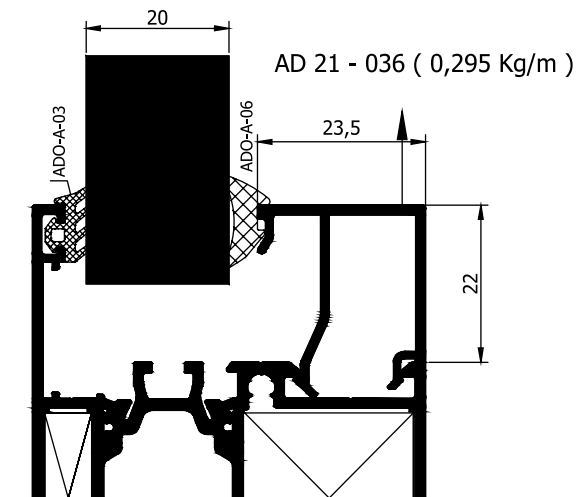
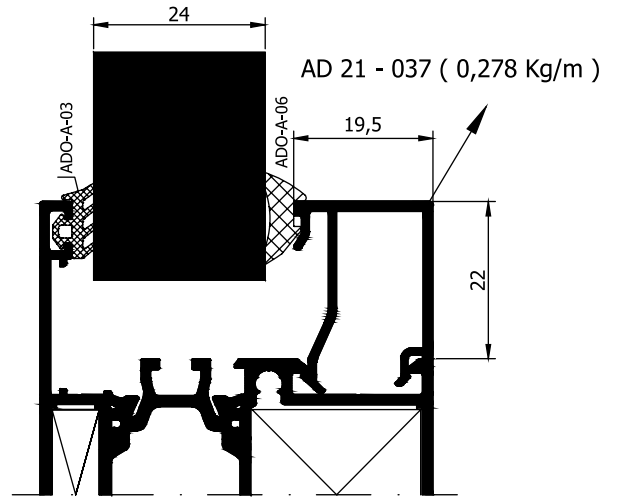
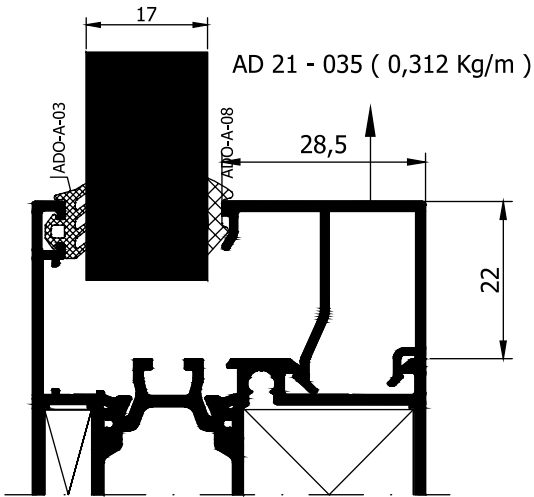
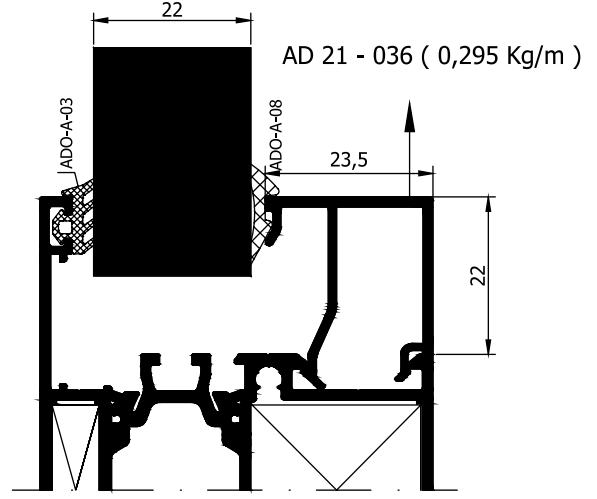
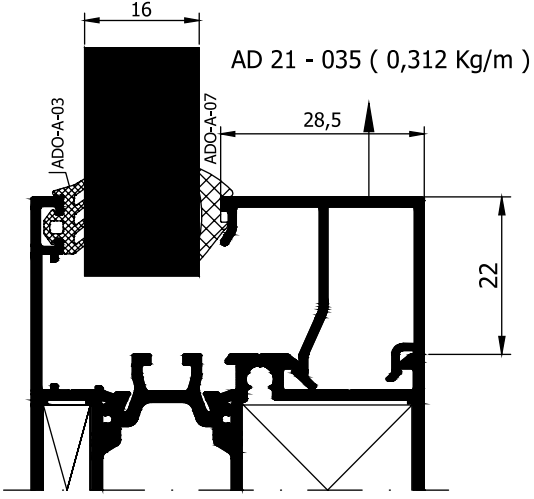

Uyarı: Tablodaki profil ağırlıklarımız teorik olup; teslim anındaki tartımız geçerlidir.

## AD 55 T YALITIMLI DOĞRAMA SİSTEMİ ÇİTA PROFİLLERİ VE CAM KOMBİNASYONU

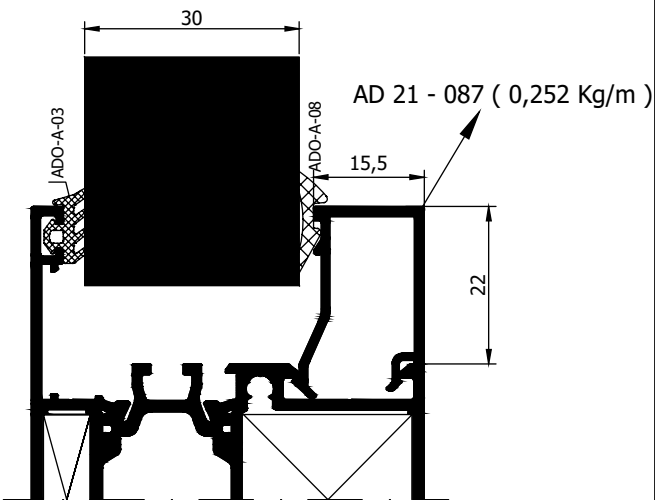
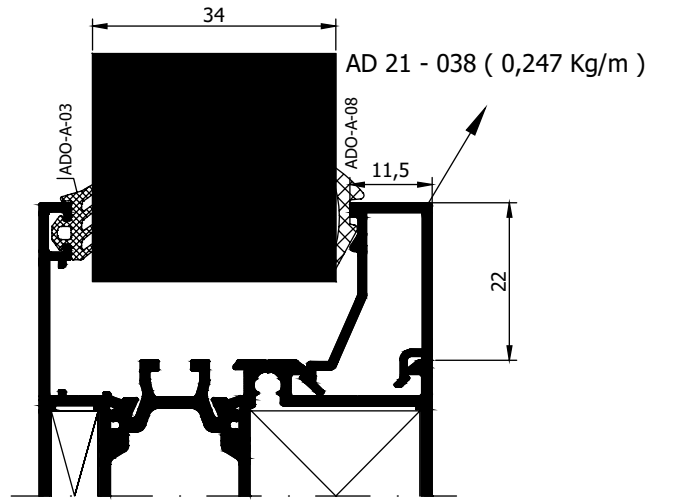
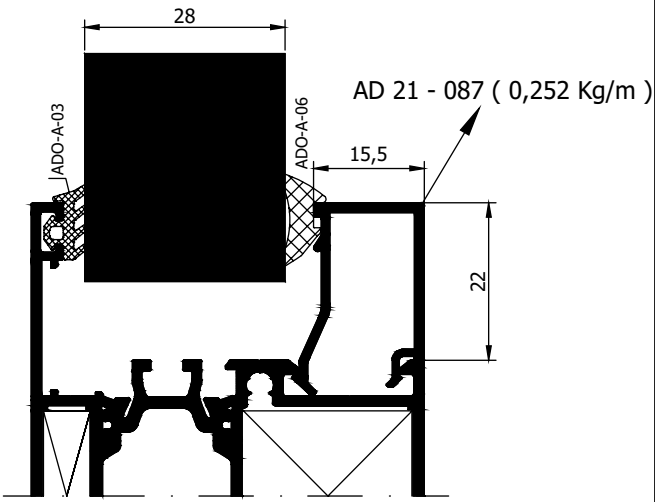
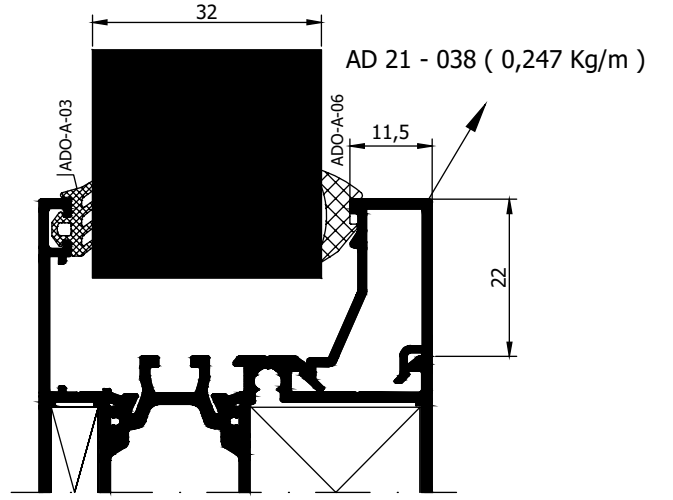
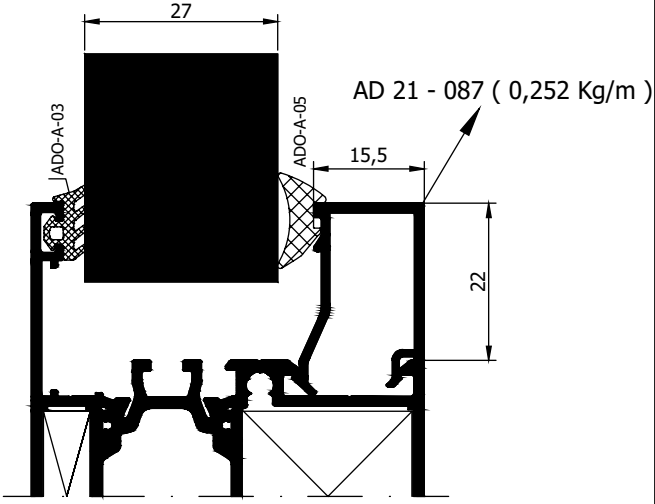

Uyarı: Tablodaki profil ağırlıklarımız teorik olup; teslim anındaki tartımız geçerlidir.

## AD 55 T YALITIMLI DOĞRAMA SİSTEMİ

	800 mm	1000 mm	1200 mm	1400 mm	1600 mm	1800 mm	2000 mm	2200 mm	2400 mm	2600 mm	2800 mm	3000 mm
AD21-015	9,17	10,62	11,72	12,55	13,18	13,65	14,02	14,31	14,54	14,73	14,88	15,00
AD21-016	10,23	11,91	13,23	14,24	15,02	15,61	16,08	16,45	16,75	16,98	17,18	17,34
AD21-017	11,22	13,14	14,68	15,88	16,81	17,54	18,11	18,57	18,94	19,24	19,48	19,69
AD21-018	12,52	14,76	16,60	18,08	19,24	20,16	20,90	21,49	21,96	22,36	22,68	22,95
AD21-019	15,54	18,48	21,04	23,19	24,95	26,40	27,57	28,54	29,34	30,00	30,55	31,01
AD21-023	46,17	52,64	58,30	63,06	66,99	70,22	72,85	75,02	76,80	78,28	79,52	80,57
AD21-024	86,23	96,58	106,01	114,24	121,25	127,13	132,05	136,16	139,61	142,50	144,94	147,02
AD21-055	12,73	15,09	17,06	18,64	19,90	20,91	21,71	22,36	22,88	23,32	23,67	23,97
AD21-066	10,33	12,12	13,53	14,62	15,46	16,10	16,61	17,01	17,34	17,60	17,81	17,99
AD21-067	11,58	13,66	15,35	16,69	17,74	18,56	19,21	19,73	20,15	20,49	20,77	21,01
AD21-068	13,82	16,43	18,66	20,48	21,96	23,16	24,12	24,90	25,54	26,07	26,50	26,87
AD21-069	16,80	20,06	22,99	25,51	27,63	29,40	30,87	32,08	33,09	33,94	34,65	35,26
AD21-071	53,92	61,63	68,64	74,75	79,95	84,32	87,96	91,00	93,55	95,69	97,49	99,03
AD21-072	101,02	113,11	124,57	134,93	144,02	151,87	158,59	164,30	169,16	173,30	176,84	179,88

PROFİL KODU	1. BAĞLANTI PROFİL KODU	2. BAĞLANTI PROFİL KODU
AD21-001	AD21-074	AD21-075
AD21-002	AD21-074	AD21-075
AD21-003	AD21-074	AD21-075
AD21-004	AD21-074	AD21-075
AD21-005	AD21-074	AD21-075
AD21-006	AD21-074	AD21-075
AD21-007	AD21-074	AD21-076
AD21-008	AD21-074	AD21-076
AD21-009	AD21-074	AD21-076
AD21-010	AD21-074	AD21-076
AD21-011	AD21-074	AD21-076
AD21-012	AD21-074	AD21-076
AD21-013	AD21-074	AD21-076
AD21-014	AD21-074	AD21-076
AD21-015	AD21-074	AD21-075
AD21-016	AD21-074	AD21-075
AD21-017	AD21-074	AD21-075
AD21-018	AD21-074	AD21-075
AD21-019	AD21-074	AD21-075
AD21-020	AD21-074	AD21-075
AD21-021	AD21-074	AD21-077
AD21-022	AD21-074	AD21-077
AD21-023	AD21-074	AD21-075
AD21-024	AD21-074	AD21-075
AD21-051	AD21-074	AD21-075
AD21-052	AD21-074	AD21-076
AD21-053	AD21-074	AD21-076
AD21-054	AD21-074	AD21-076
AD21-055	AD21-074	AD21-075
AD21-056	AD21-074	AD21-075
AD21-057	AD21-074	AD21-075
AD21-058	AD21-074	AD21-075
AD21-059	AD21-074	AD21-075
AD21-060	AD21-074	AD21-075
AD21-061	AD21-074	AD21-076
AD21-062	AD21-074	AD21-076
AD21-063	AD21-074	AD21-076
AD21-064	AD21-074	AD21-076
AD21-065	AD21-074	AD21-076
AD21-066	AD21-074	AD21-075
AD21-067	AD21-074	AD21-075
AD21-068	AD21-074	AD21-075
AD21-069	AD21-074	AD21-075
AD21-070	AD21-074	AD21-075
AD21-071	AD21-074	AD21-075
AD21-072	AD21-074	AD21-075
AD21-073	AD21-074	AD21-076
AD21-078	AD21-074	AD21-077
AD21-079	AD21-074	AD21-077
AD21-088	AD21-074	AD21-075



**AD 55 T YALITIMLI DOĞRAMA SİSTEMİ**

AD 55 T YALITIMLI SERİ			
PROFİL KODU	KÖŞE ÇAVUŞU KODU	AÇIKLAMA	ADET
AD21-001	005.002.003.00	KÖŞE ÇAVUŞU 45x18.7	1
AD21-002	005.002.003.00	KÖŞE ÇAVUŞU 45x18.7	1
AD21-003	005.002.003.00	KÖŞE ÇAVUŞU 45x18.7	1
AD21-004	005.002.003.00	KÖŞE ÇAVUŞU 45x18.7	1
AD21-005	005.002.003.00	KÖŞE ÇAVUŞU 45x18.7	2
AD21-006	005.002.003.00	KÖŞE ÇAVUŞU 45x18.7	2
AD21-007	005.002.001.00	KÖŞE ÇAVUŞU 39.7x15.7	1
	005.002.002.00	KÖŞE ÇAVUŞU 35x14.2	1
AD21-008	005.002.001.00	KÖŞE ÇAVUŞU 39.7x15.7	1
	005.002.002.00	KÖŞE ÇAVUŞU 35x14.2	1
AD21-009	005.002.001.00	KÖŞE ÇAVUŞU 39.7x15.7	1
	005.002.002.00	KÖŞE ÇAVUŞU 35x14.2	1
AD21-010	005.002.001.00	KÖŞE ÇAVUŞU 39.7x15.7	1
	005.002.002.00	KÖŞE ÇAVUŞU 35x14.2	1
AD21-011	005.002.001.00	KÖŞE ÇAVUŞU 39.7x15.7	1
	005.002.002.00	KÖŞE ÇAVUŞU 35x14.2	1
AD21-012	005.002.001.00	KÖŞE ÇAVUŞU 39.7x15.7	1
	005.002.002.00	KÖŞE ÇAVUŞU 35x14.2	1
AD21-013	005.002.001.00	KÖŞE ÇAVUŞU 39.7x15.7	1
	005.002.002.00	KÖŞE ÇAVUŞU 35x14.2	1
AD21-014	005.002.001.00	KÖŞE ÇAVUŞU 39.7x15.7	1
	005.002.002.00	KÖŞE ÇAVUŞU 35x14.2	1
AD21-015	005.002.003.00	KÖŞE ÇAVUŞU 45x18.7	2
AD21-016	005.002.003.00	KÖŞE ÇAVUŞU 45x18.7	2
AD21-017	005.002.003.00	KÖŞE ÇAVUŞU 45x18.7	2
AD21-018	005.002.003.00	KÖŞE ÇAVUŞU 45x18.7	2
AD21-019	005.002.003.00	KÖŞE ÇAVUŞU 45x18.7	2
AD21-020	005.002.003.00	KÖŞE ÇAVUŞU 45x18.7	1
AD21-021	005.002.001.00	KÖŞE ÇAVUŞU 39.7x15.7	1
AD21-022	005.002.001.00	KÖŞE ÇAVUŞU 39.7x15.7	1
AD21-023	005.002.003.00	KÖŞE ÇAVUŞU 45x18.7	2
AD21-024	005.002.003.00	KÖŞE ÇAVUŞU 45x18.7	2
AD21-026	005.002.003.00	KÖŞE ÇAVUŞU 45x18.7	1
AD21-027	005.002.002.00	KÖŞE ÇAVUŞU 35x14.2	1
AD21-051	005.002.003.00	KÖŞE ÇAVUŞU 45x18.7	1
AD21-052	005.002.001.00	KÖŞE ÇAVUŞU 39.7x15.7	1
	005.002.002.00	KÖŞE ÇAVUŞU 35x14.2	1
AD21-053	005.002.001.00	KÖŞE ÇAVUŞU 39.7x15.7	1
	005.002.002.00	KÖŞE ÇAVUŞU 35x14.2	1
AD21-054	005.002.001.00	KÖŞE ÇAVUŞU 39.7x15.7	1
	005.002.002.00	KÖŞE ÇAVUŞU 35x14.2	1
AD21-055	005.002.003.00	KÖŞE ÇAVUŞU 45x18.7	2
AD21-056	005.002.003.00	KÖŞE ÇAVUŞU 45x18.7	1
AD21-057	005.002.003.00	KÖŞE ÇAVUŞU 45x18.7	1
AD21-058	005.002.003.00	KÖŞE ÇAVUŞU 45x18.7	1
AD21-059	005.002.003.00	KÖŞE ÇAVUŞU 45x18.7	2
AD21-060	005.002.003.00	KÖŞE ÇAVUŞU 45x18.7	2
AD21-061	005.002.001.00	KÖŞE ÇAVUŞU 39.7x15.7	1
	005.002.002.00	KÖŞE ÇAVUŞU 35x14.2	1
AD21-062	005.002.001.00	KÖŞE ÇAVUŞU 39.7x15.7	1
	005.002.002.00	KÖŞE ÇAVUŞU 35x14.2	1
AD21-063	005.002.001.00	KÖŞE ÇAVUŞU 39.7x15.7	1
	005.002.002.00	KÖŞE ÇAVUŞU 35x14.2	1
AD21-064	005.002.001.00	KÖŞE ÇAVUŞU 39.7x15.7	1
	005.002.002.00	KÖŞE ÇAVUŞU 35x14.2	1
AD21-065	005.002.001.00	KÖŞE ÇAVUŞU 39.7x15.7	1
	005.002.002.00	KÖŞE ÇAVUŞU 35x14.2	1
AD21-066	005.002.003.00	KÖŞE ÇAVUŞU 45x18.7	2
AD21-067	005.002.003.00	KÖŞE ÇAVUŞU 45x18.7	2

**AD 55 T YALITIMLI DOĞRAMA SİSTEMİ DETAYLAR**

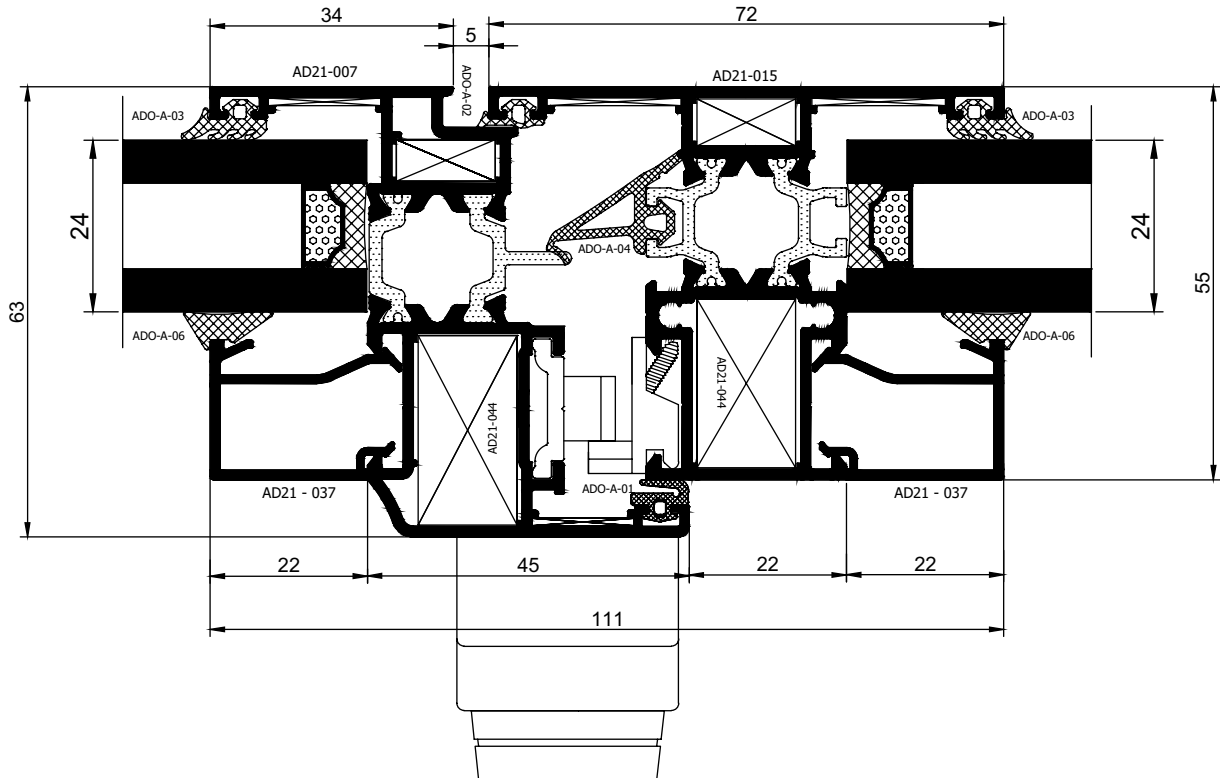
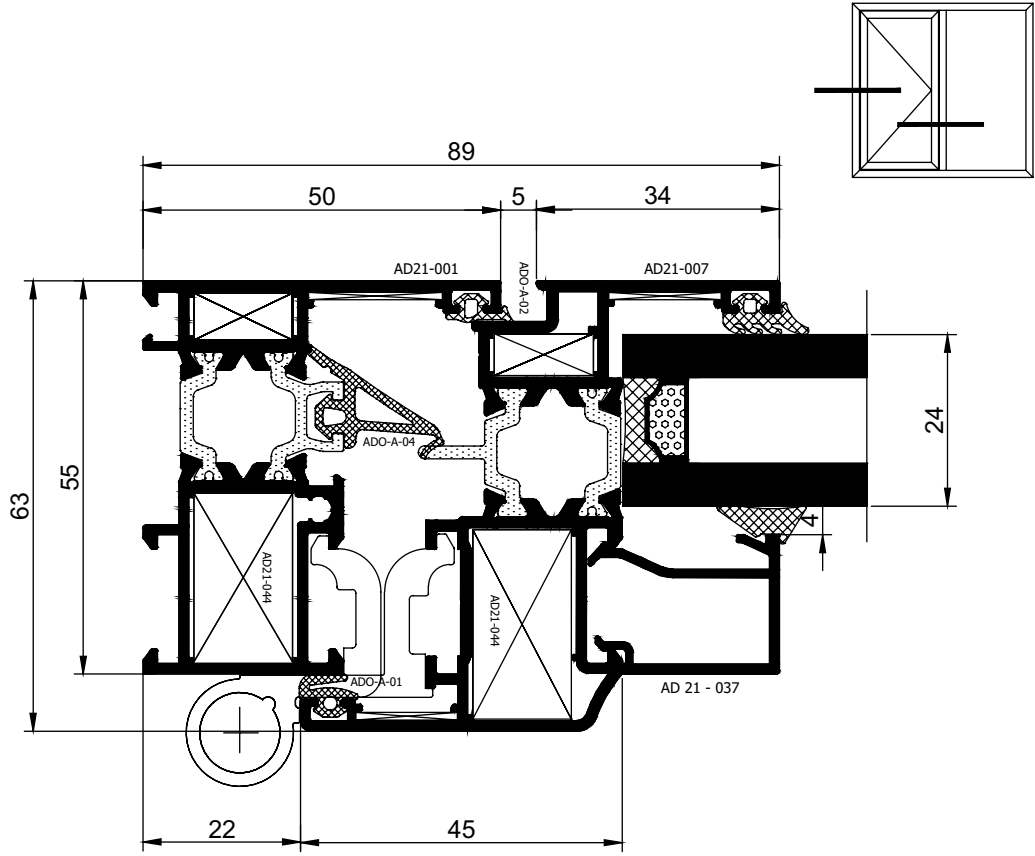

## AD 55 T YALITIMLI DOĞRAMA SİSTEMİ DETAYLAR

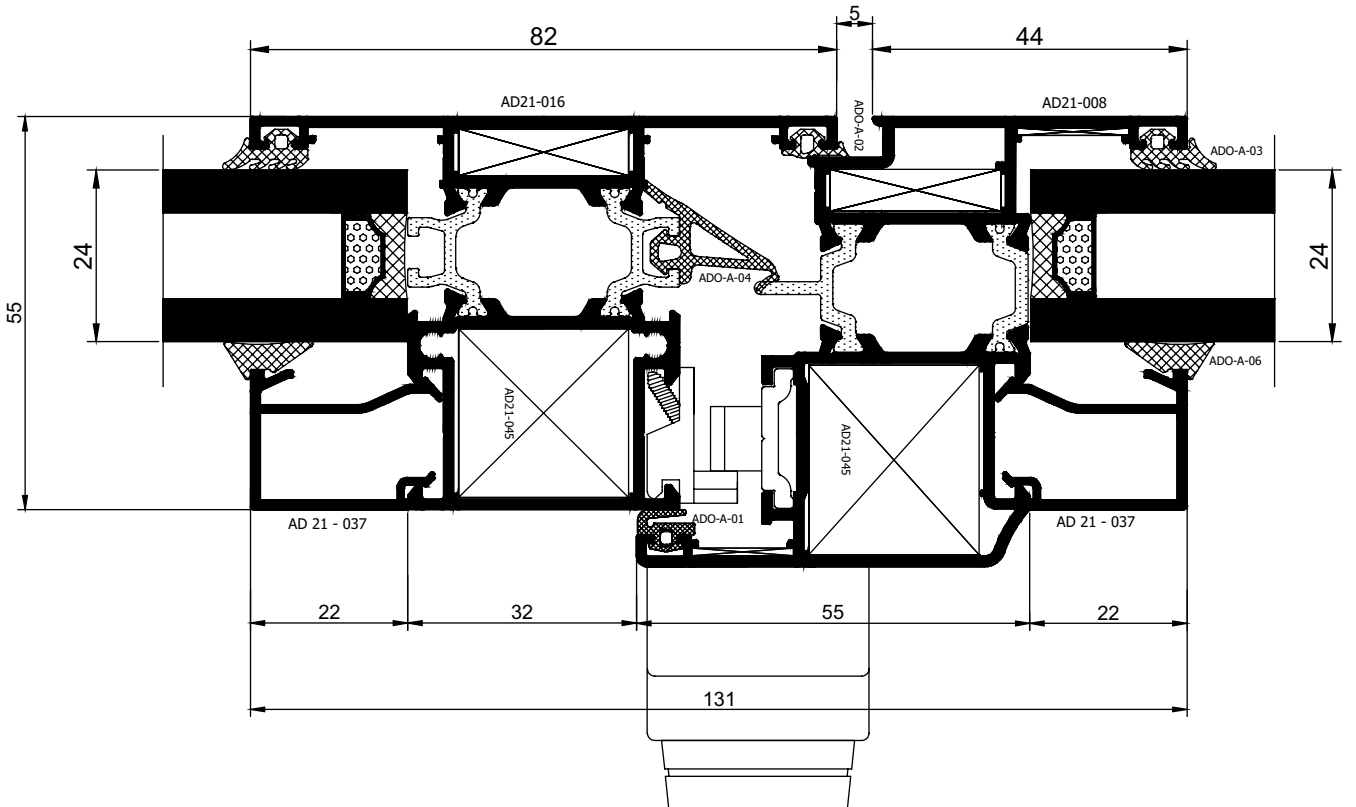
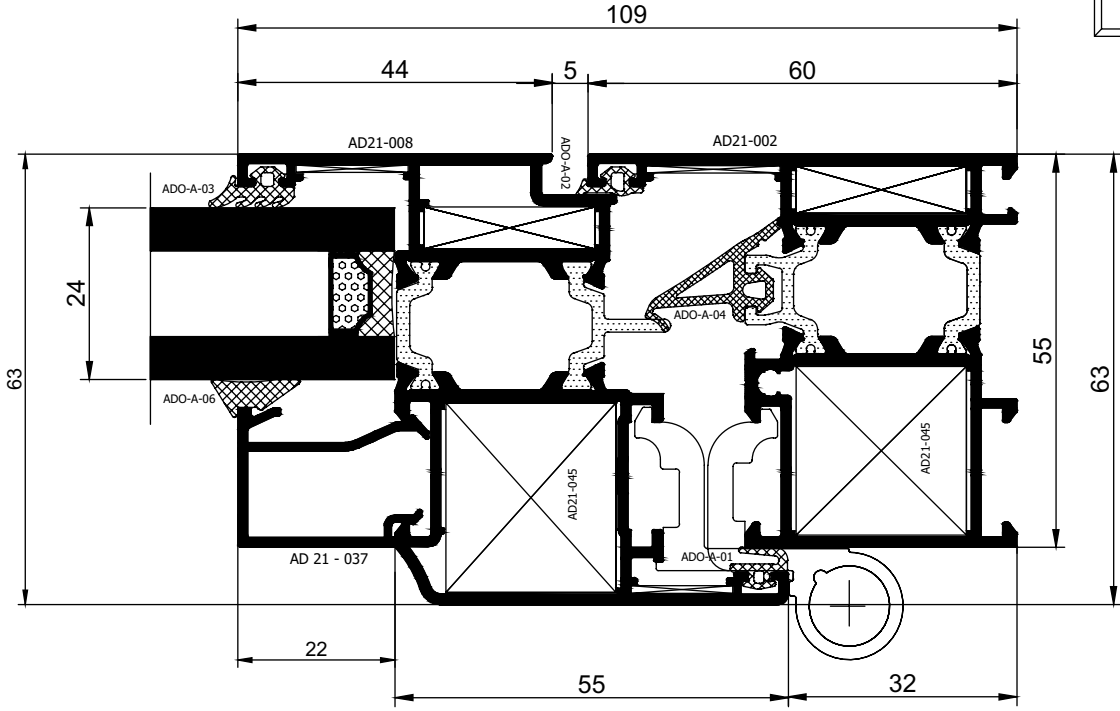
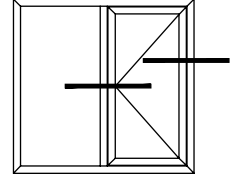

## AD 55 T YALITIMLI DOĞRAMA SİSTEMİ DETAYLAR

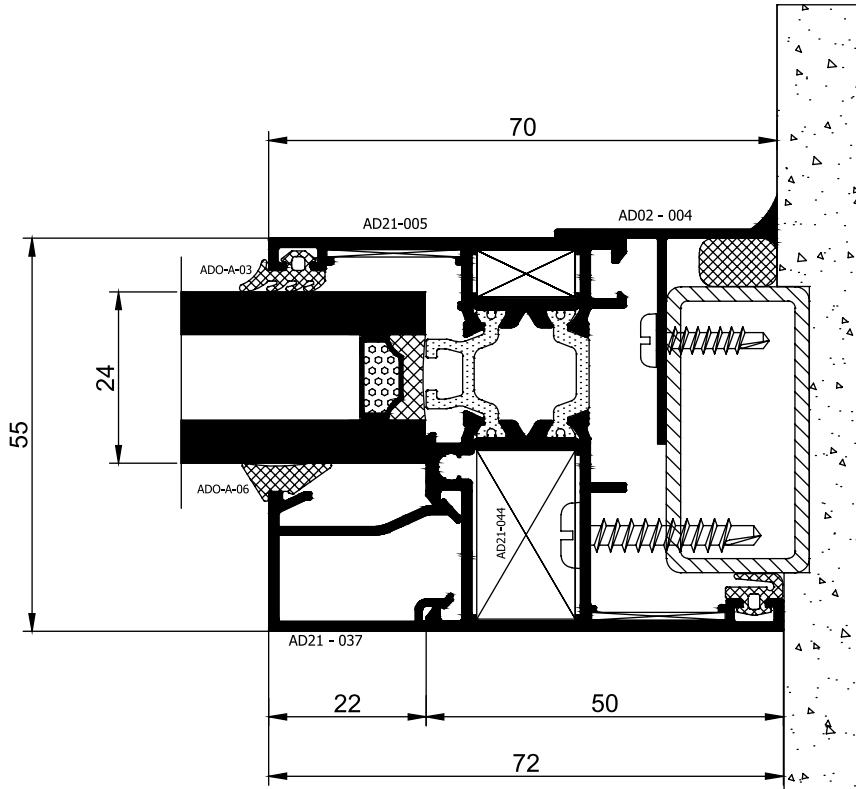
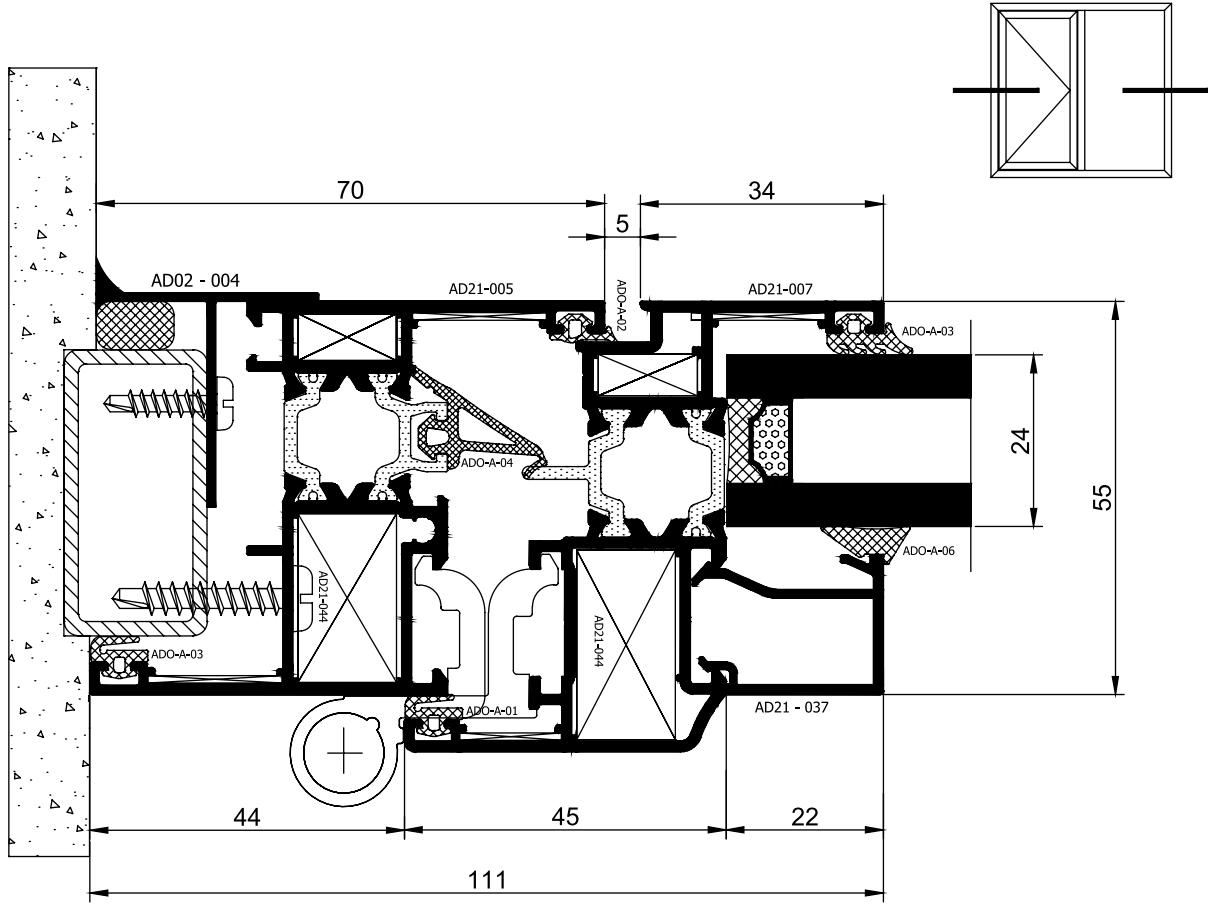

## AD 55 T YALITIMLI DOĞRAMA SİSTEMİ DETAYLAR

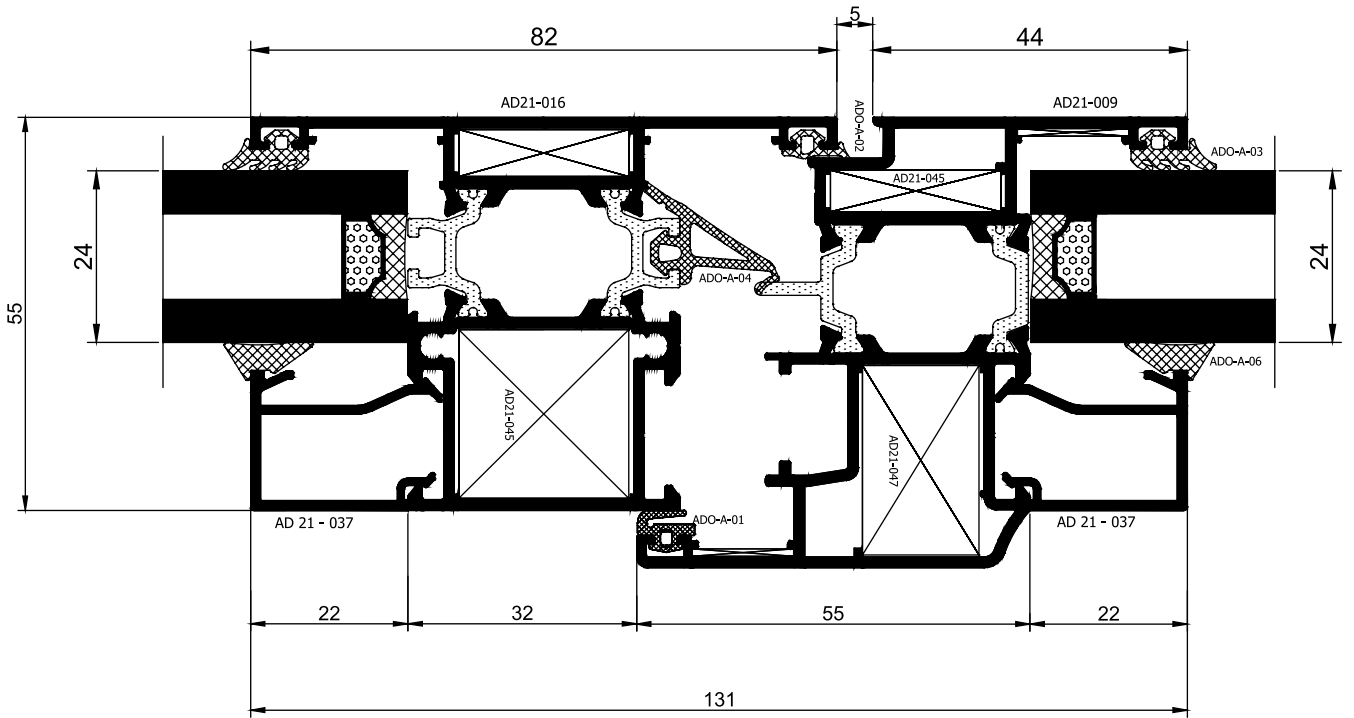
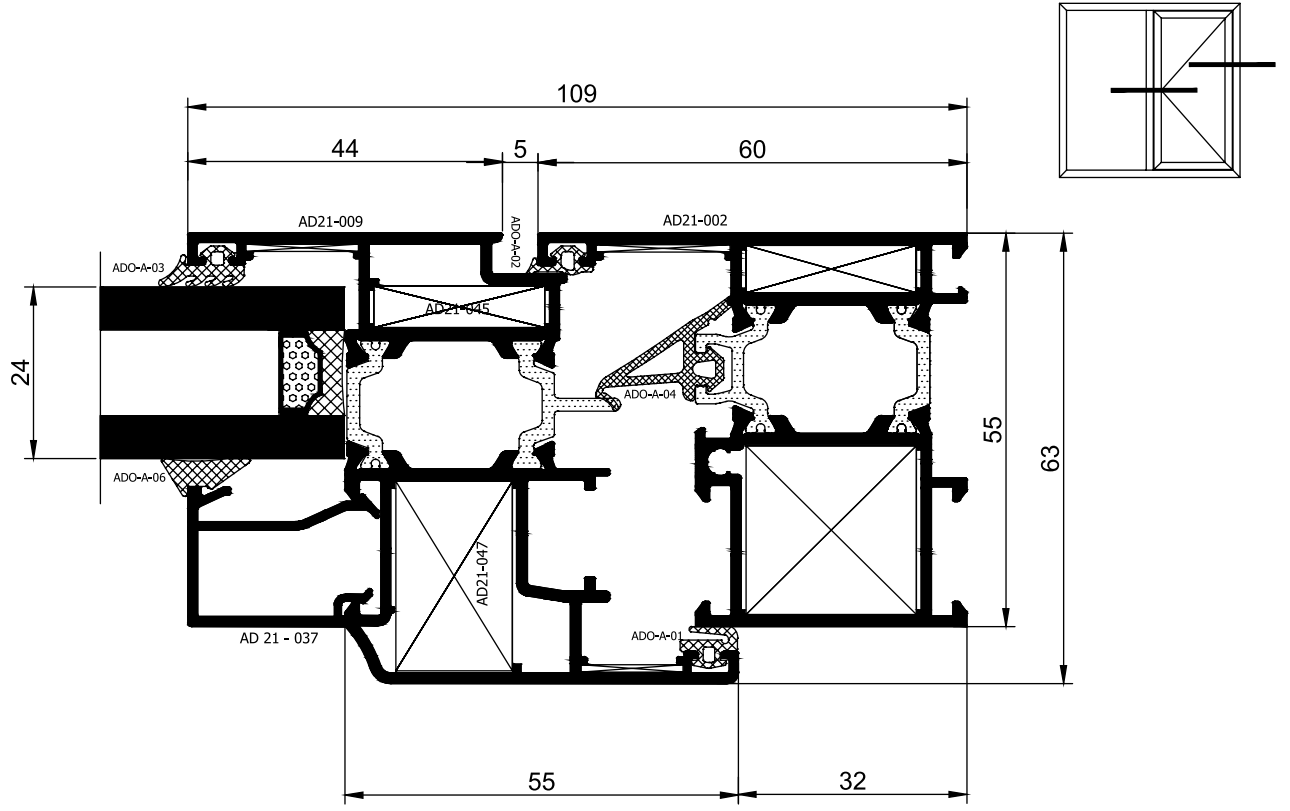

## AD 55 T YALITIMLI DOĞRAMA SİSTEMİ DETAYLAR

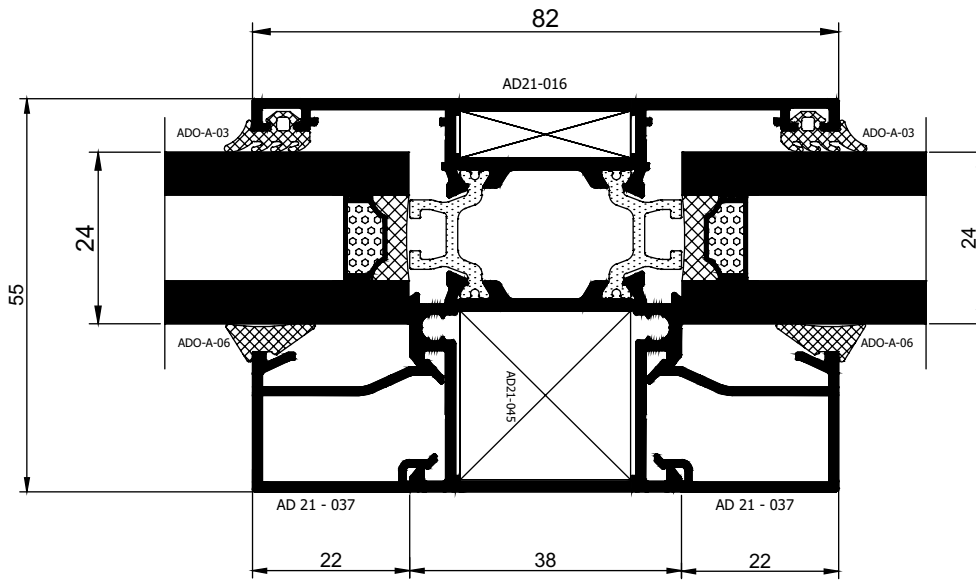
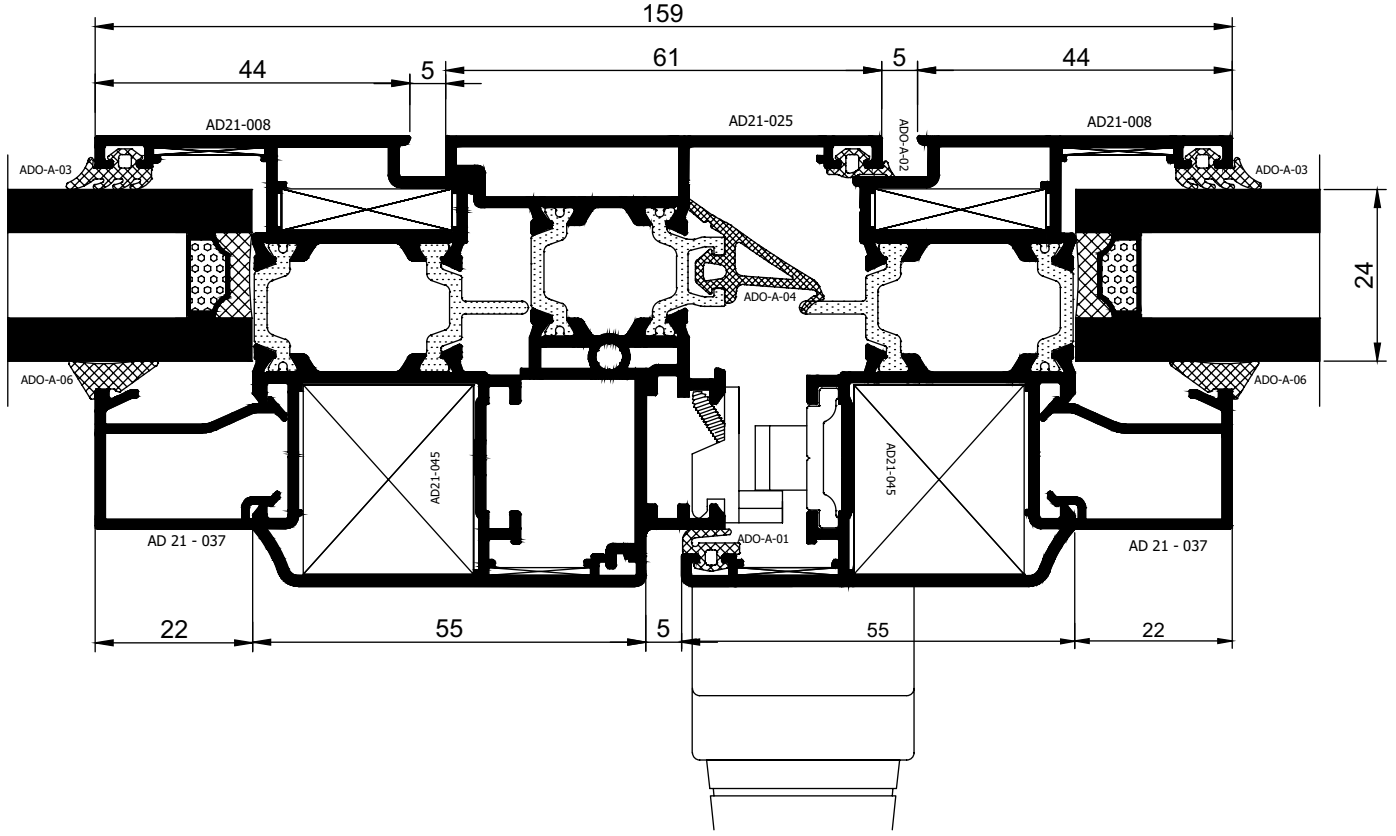
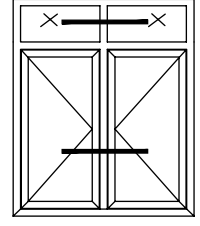

## AD 55 T YALITIMLI DOĞRAMA SİSTEMİ DETAYLAR

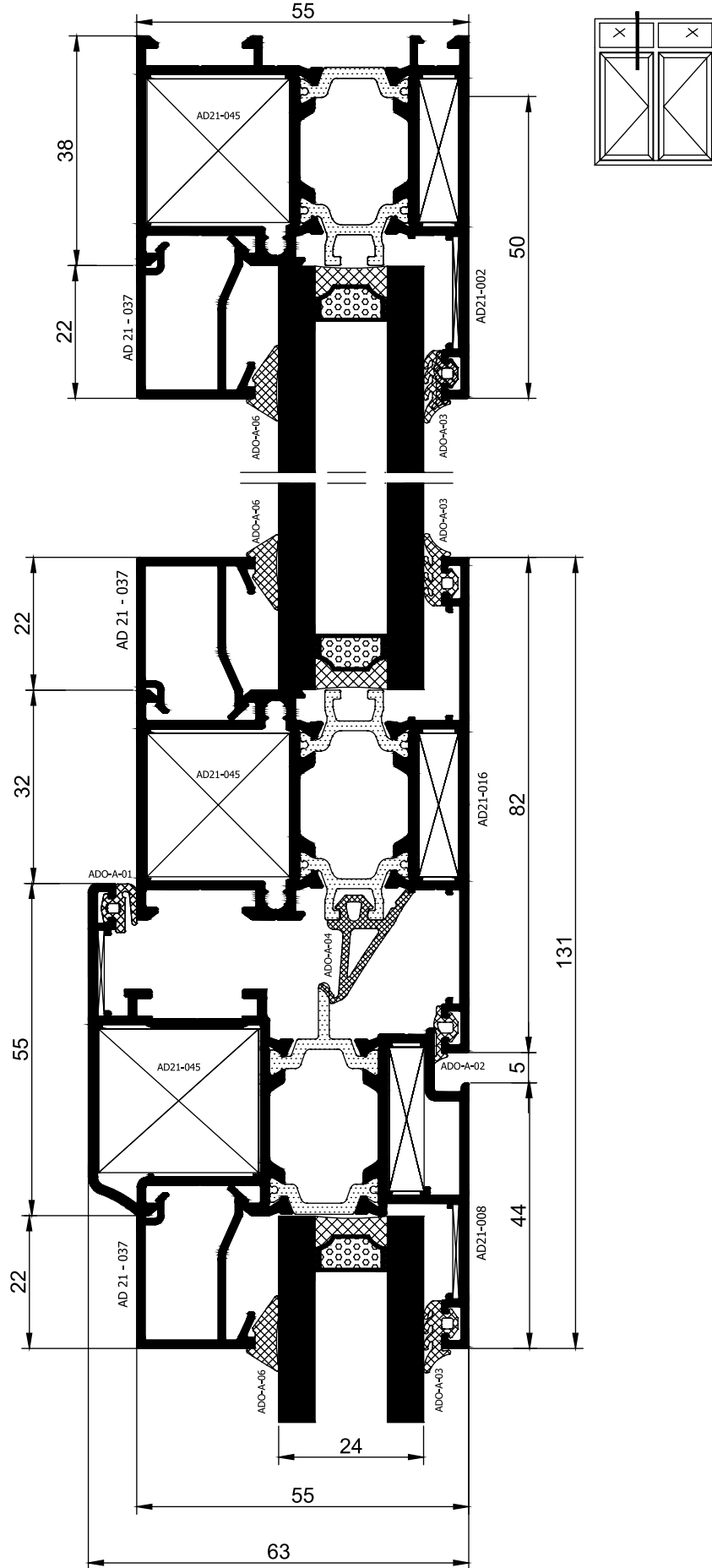





AD 55 T YALITIMLI DOĞRAMA SİSTEMİ DETAYLAR

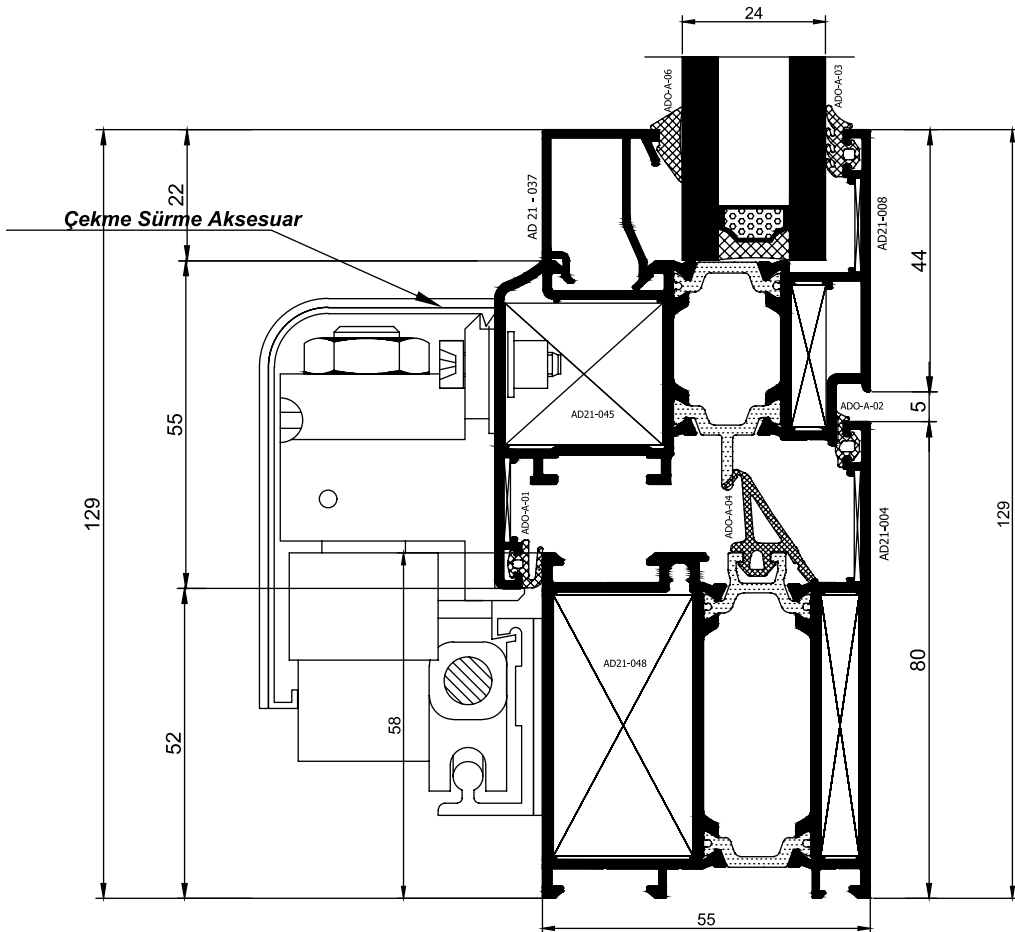
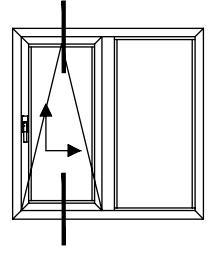
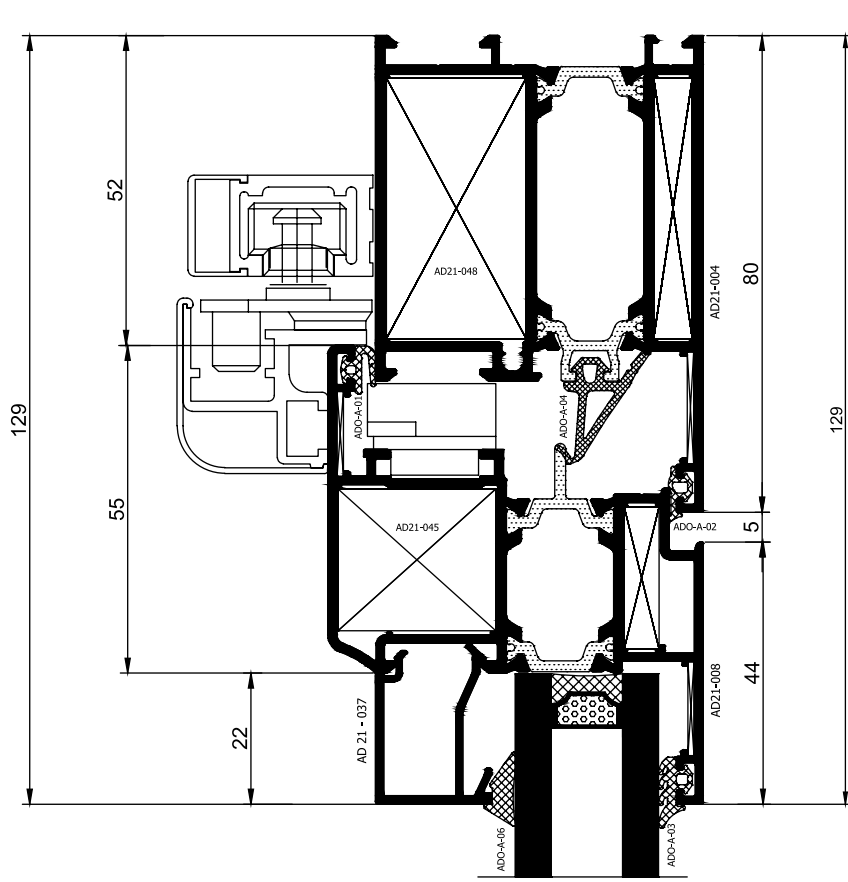

## AD 55 T YALITIMLI DOĞRAMA SİSTEMİ DETAYLAR

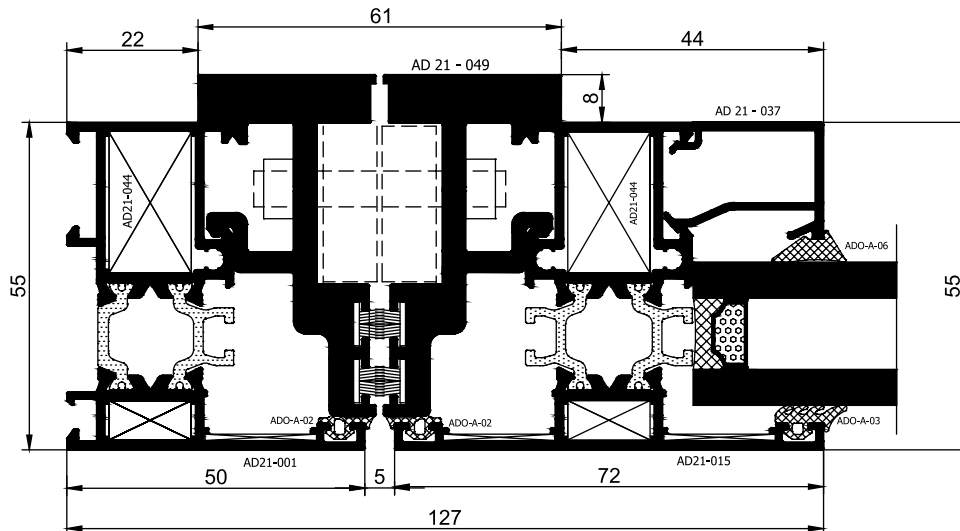
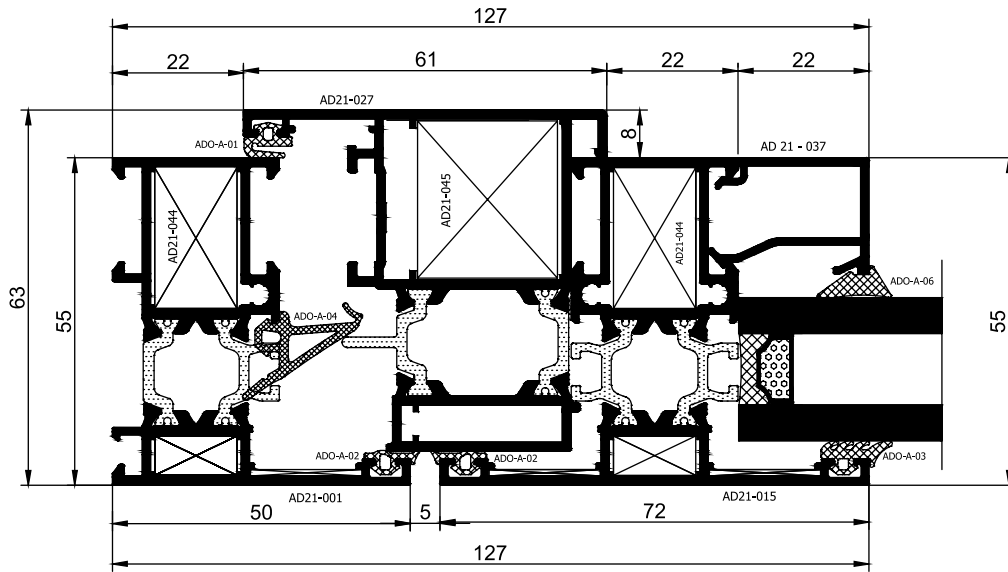
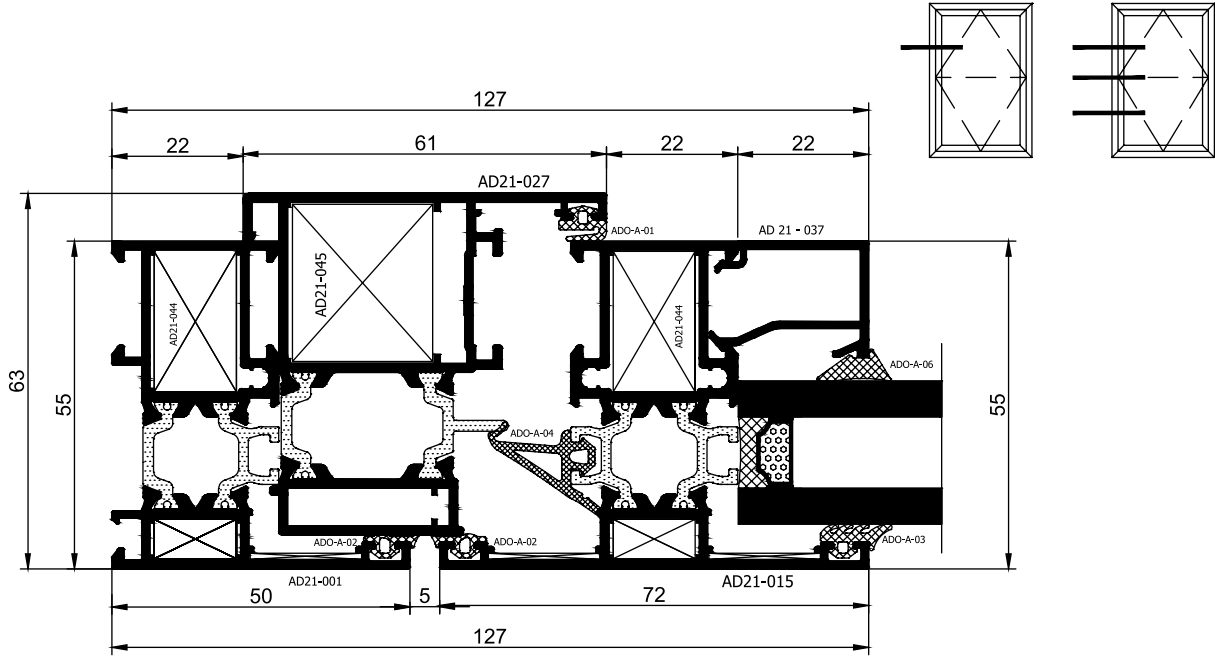



## AD 55 T YALITIMLI DOĞRAMA SİSTEMİ DETAYLAR

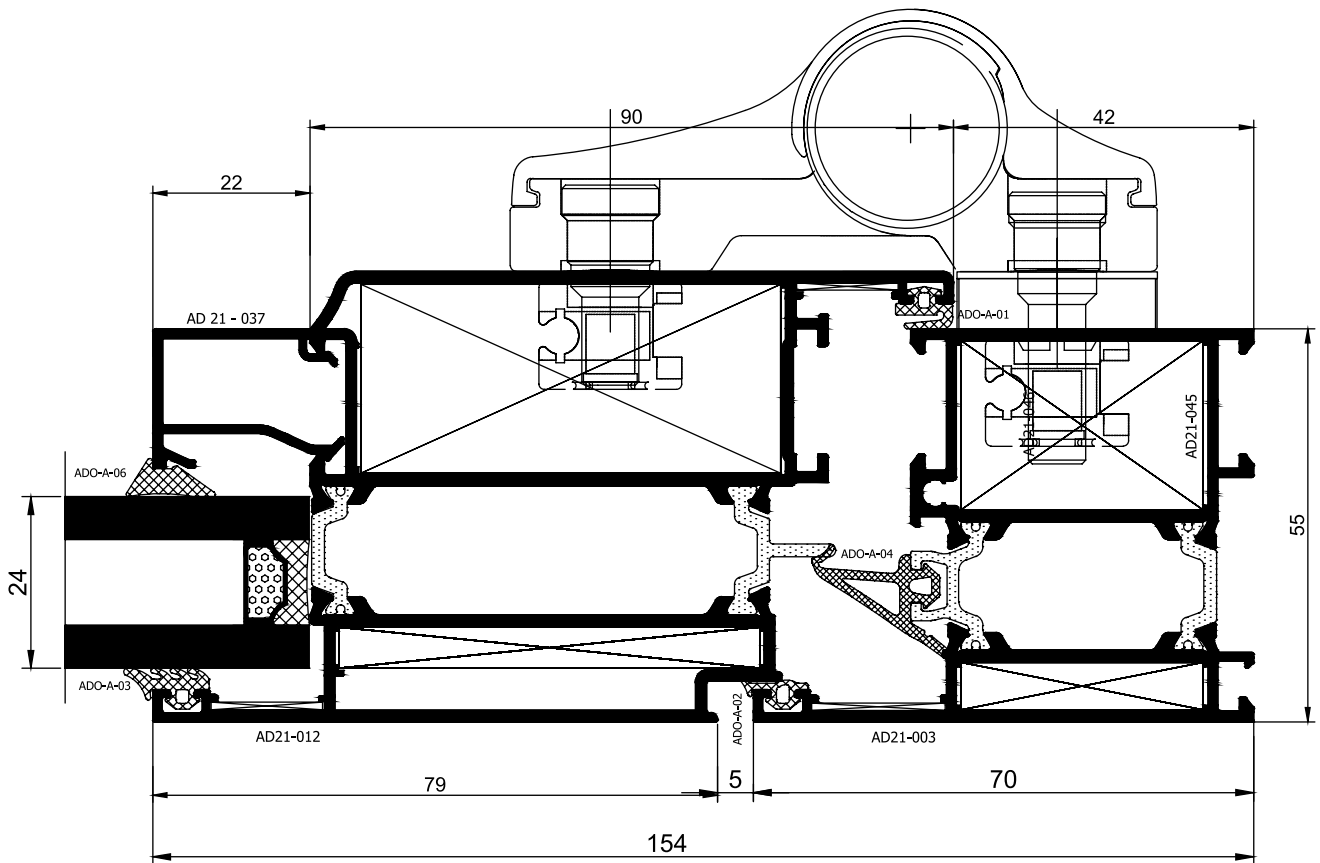
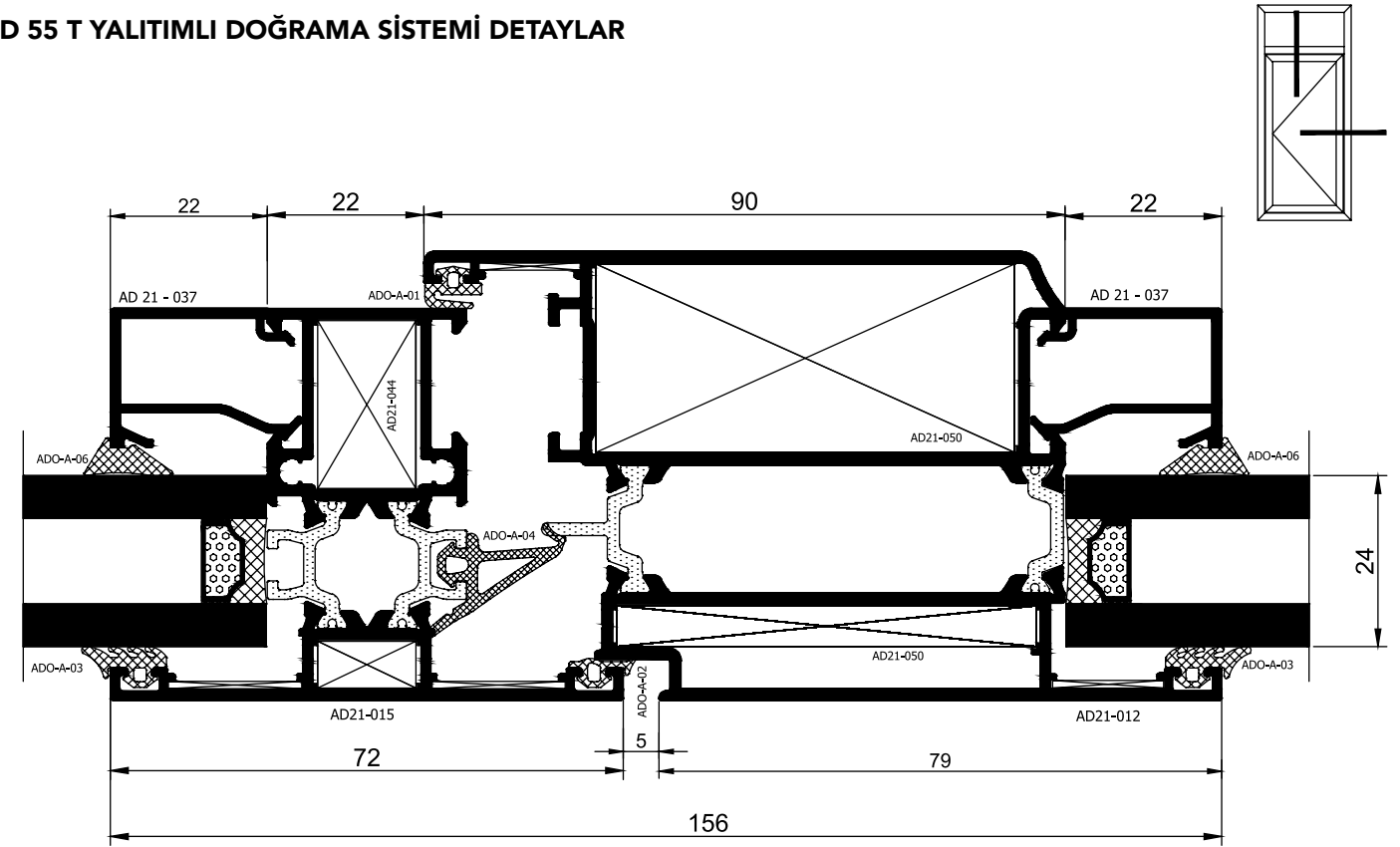

AD 55 T YALITIMLI DOĞRAMA SİSTEMİ DETAYLAR

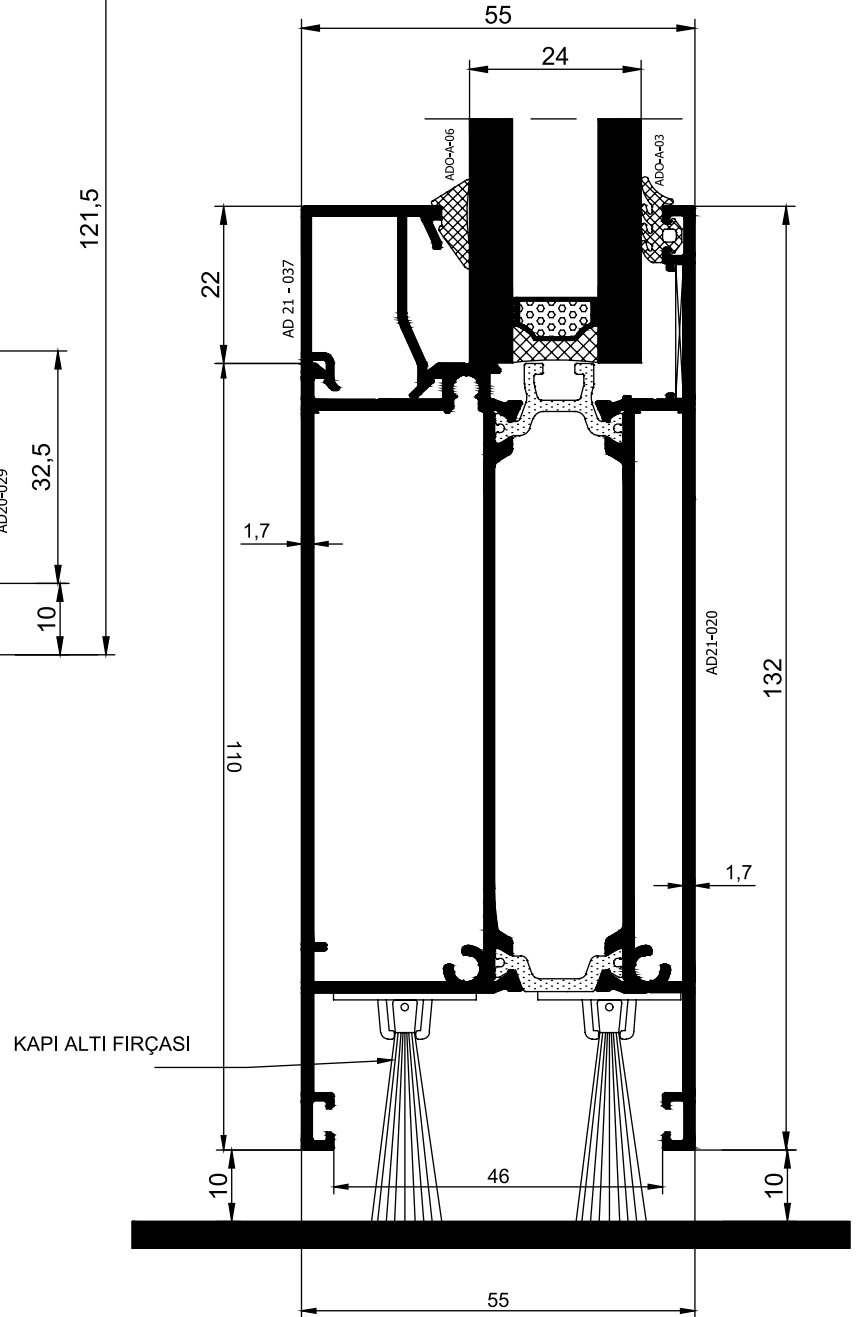
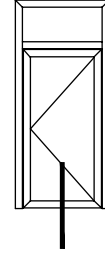
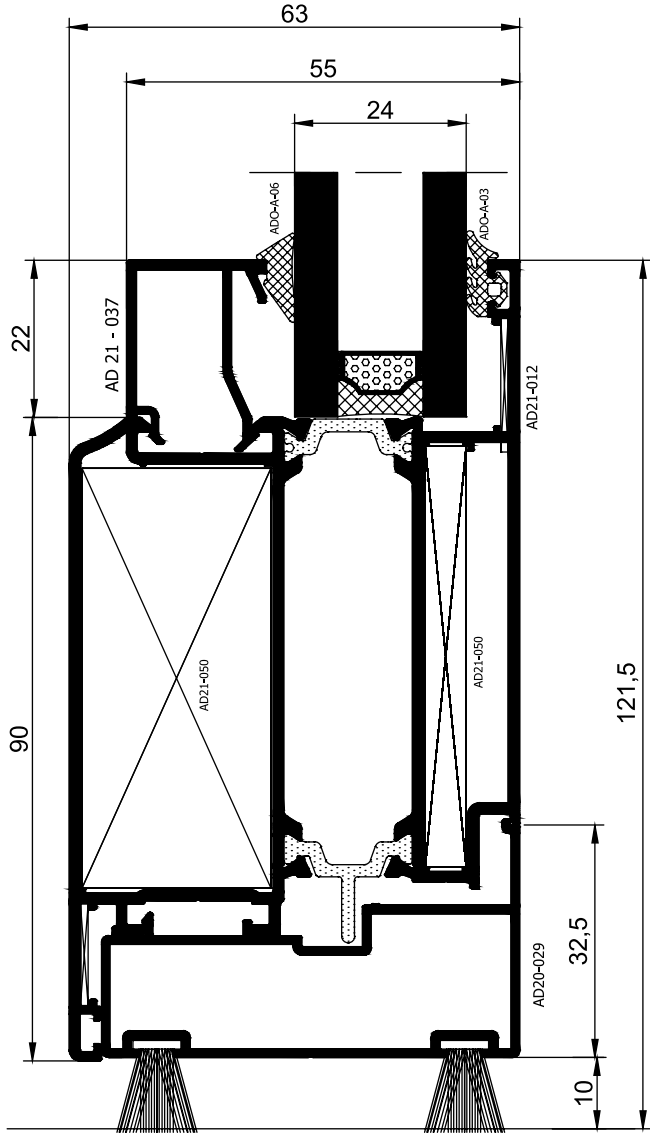

## AD 55 T YALITIMLI DOĞRAMA SİSTEMİ DETAYLAR

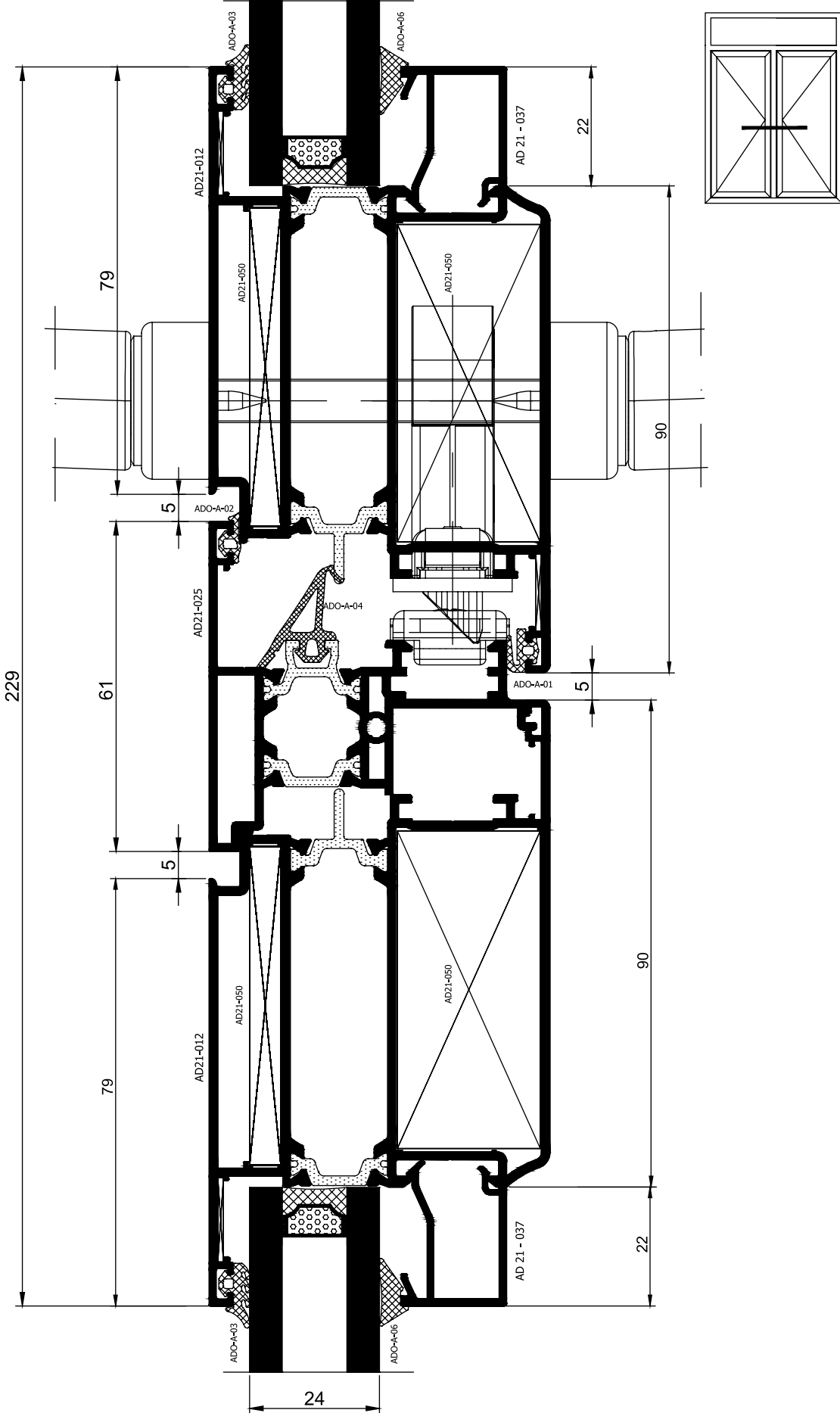

AD 55 T YALITIMLI DOĞRAMA SİSTEMİ DETAYLAR

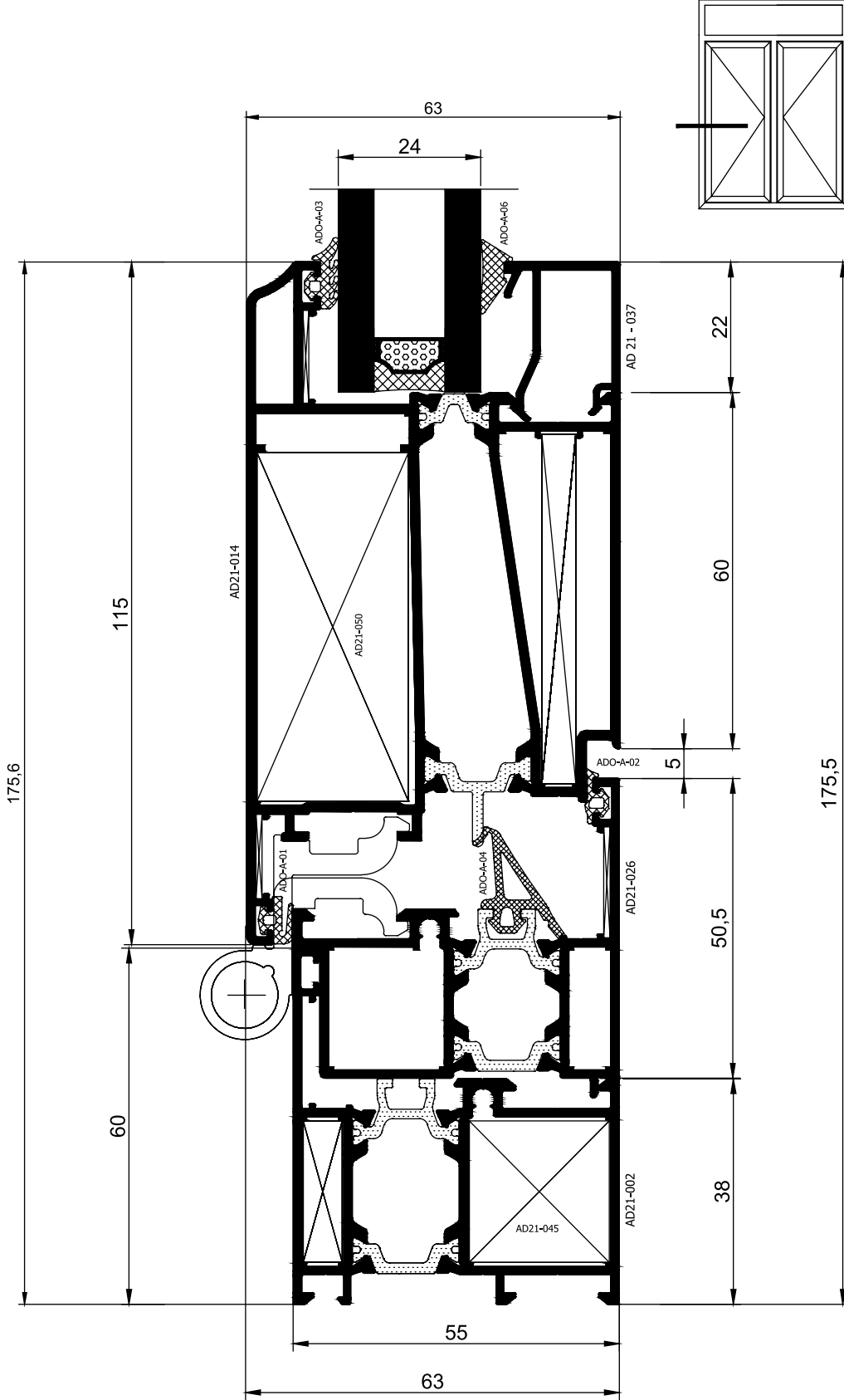

## AD 55 T YALITIMLI DOĞRAMA SİSTEMİ DETAYLAR

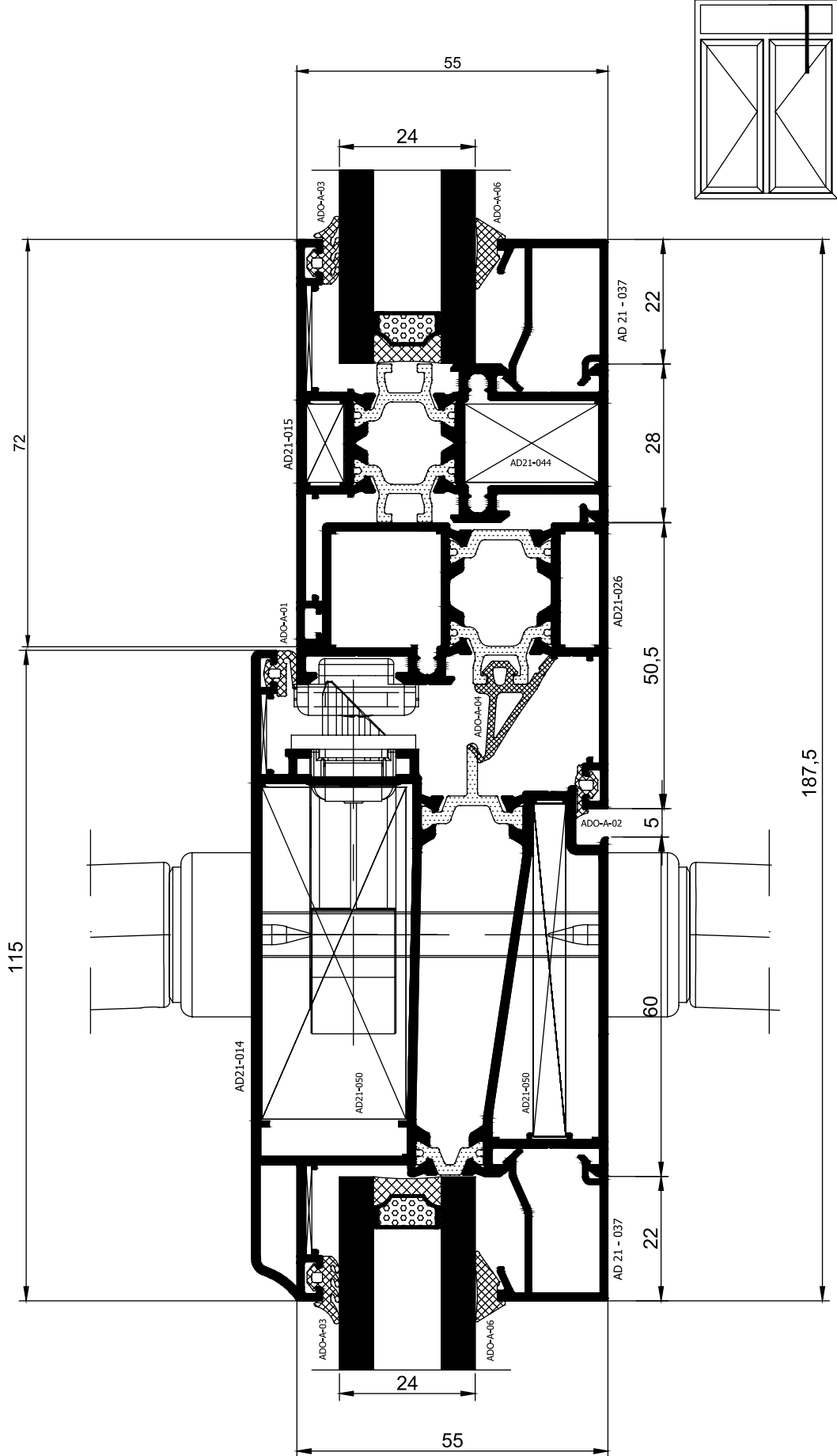





AD 55 T YALITIMLI DOĞRAMA SİSTEMİ DETAYLAR

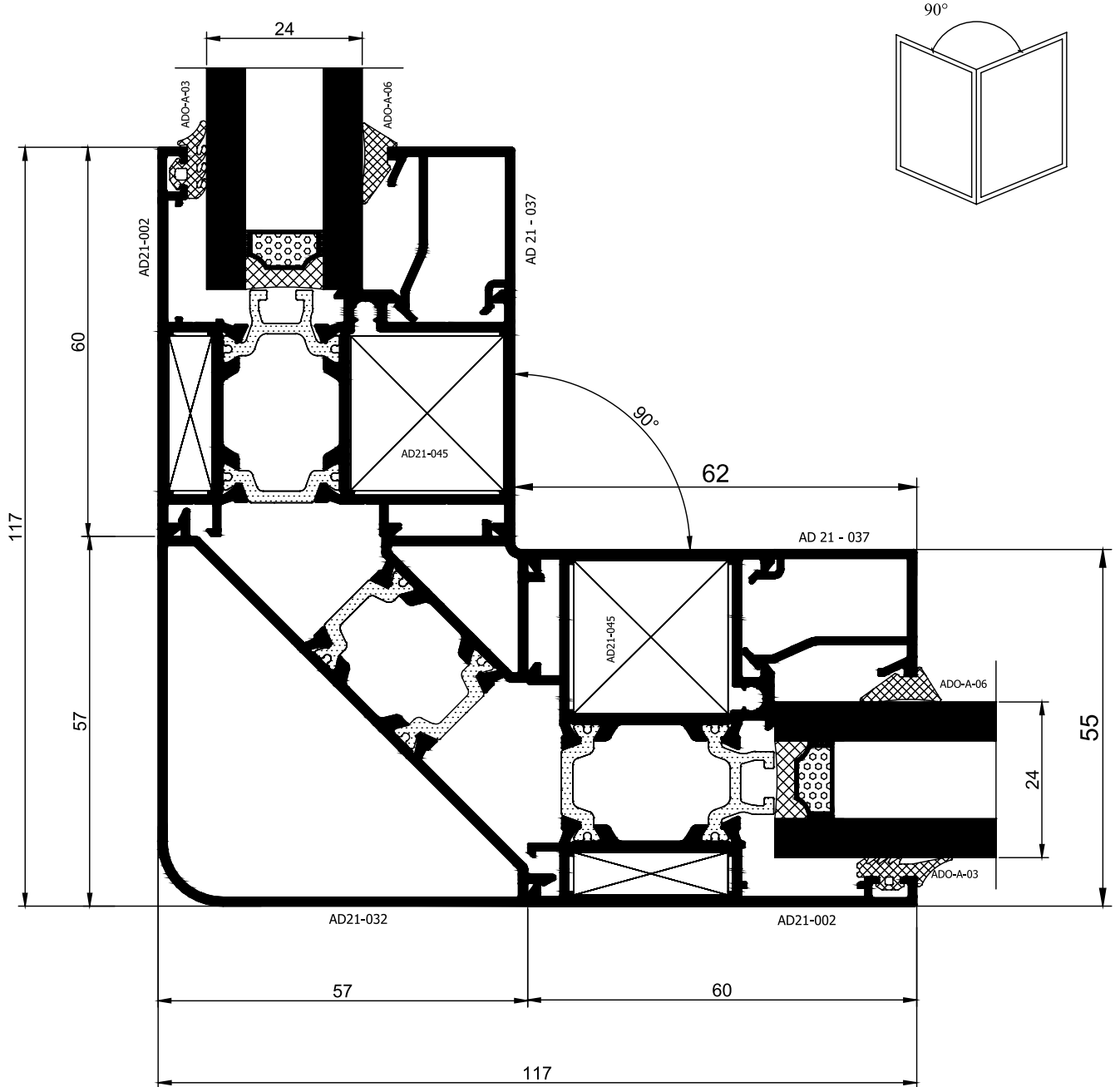

AD 55 T YALITIMLI DOĞRAMA SİSTEMİ DETAYLAR

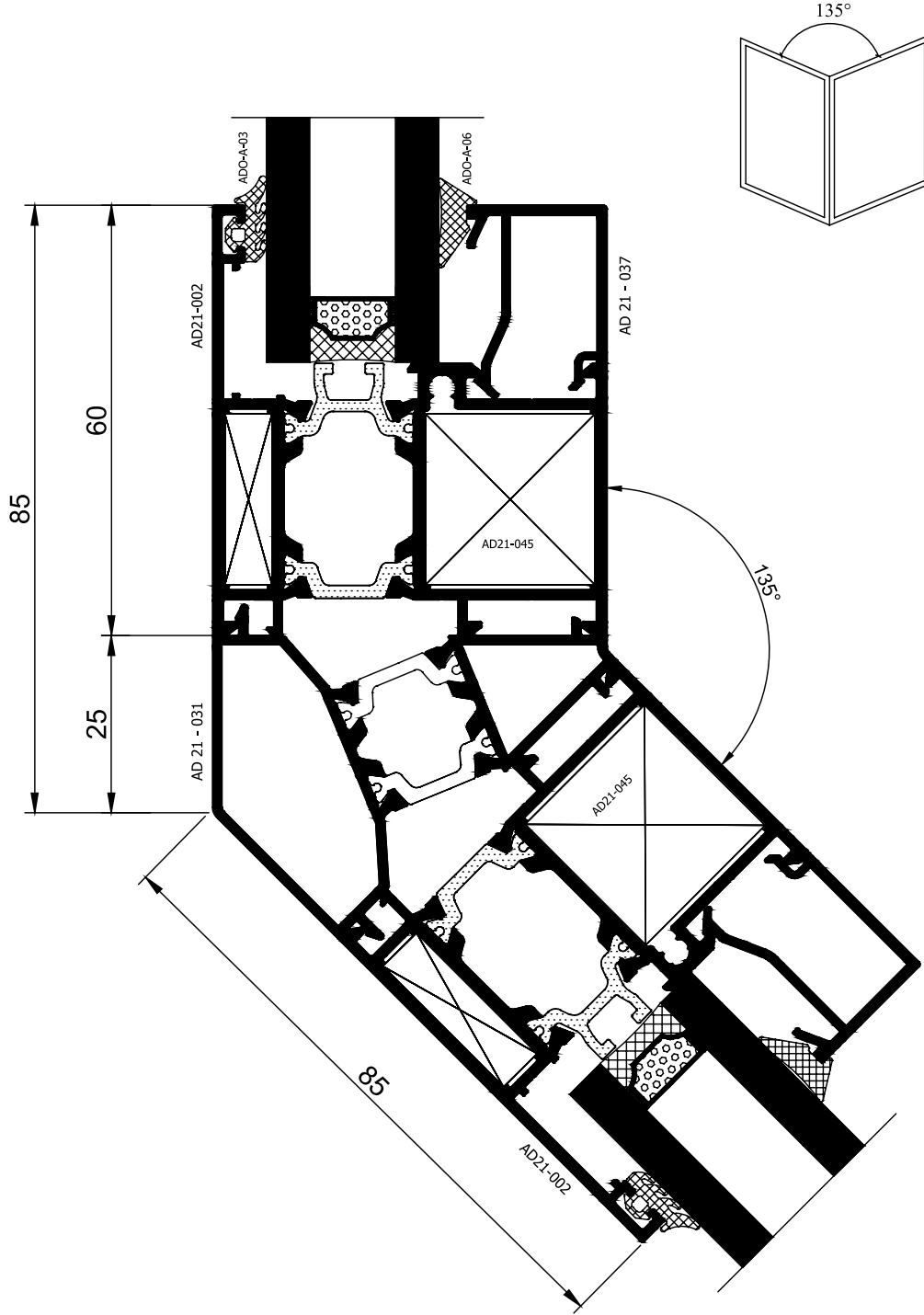

## AD 55 T YALITIMLI DOĞRAMA SİSTEMİ DETAYLAR

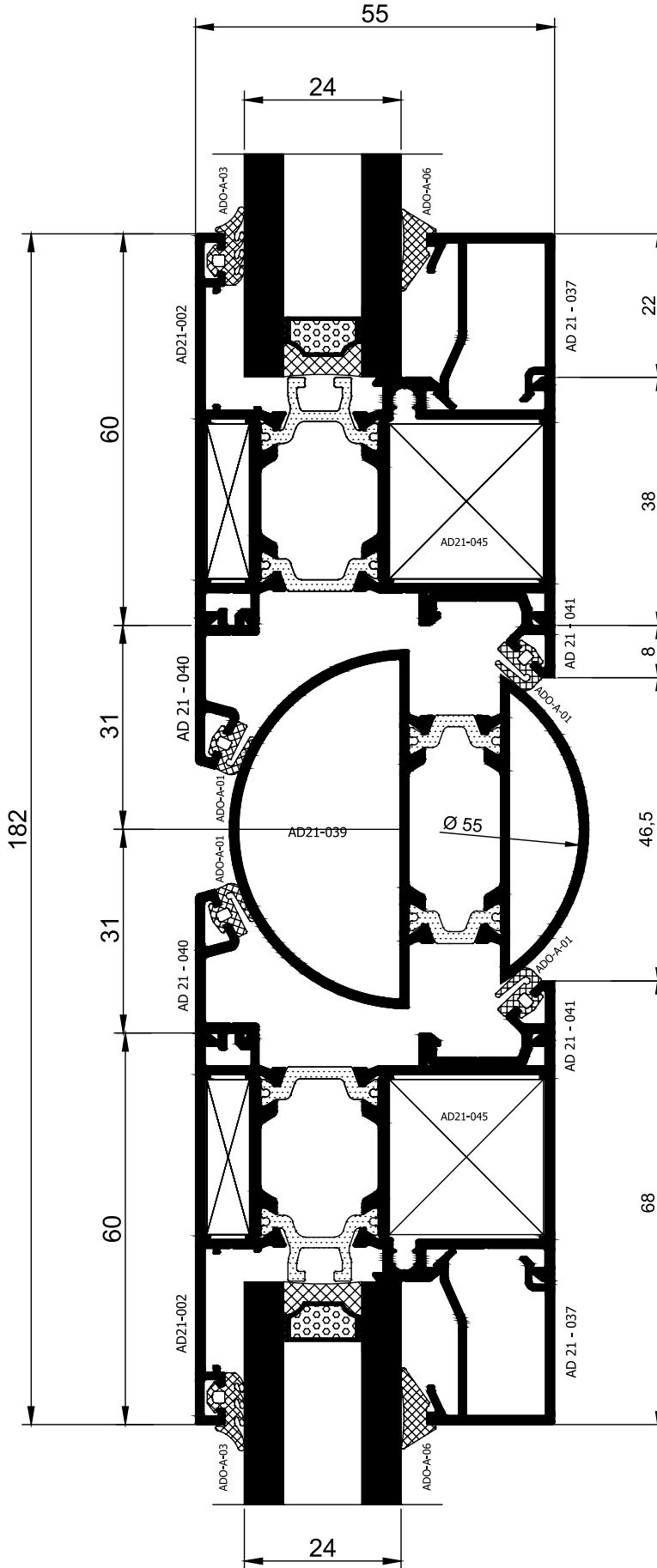

## AD 55 T YALITIMLI DOĞRAMA SİSTEMİ DETAYLAR

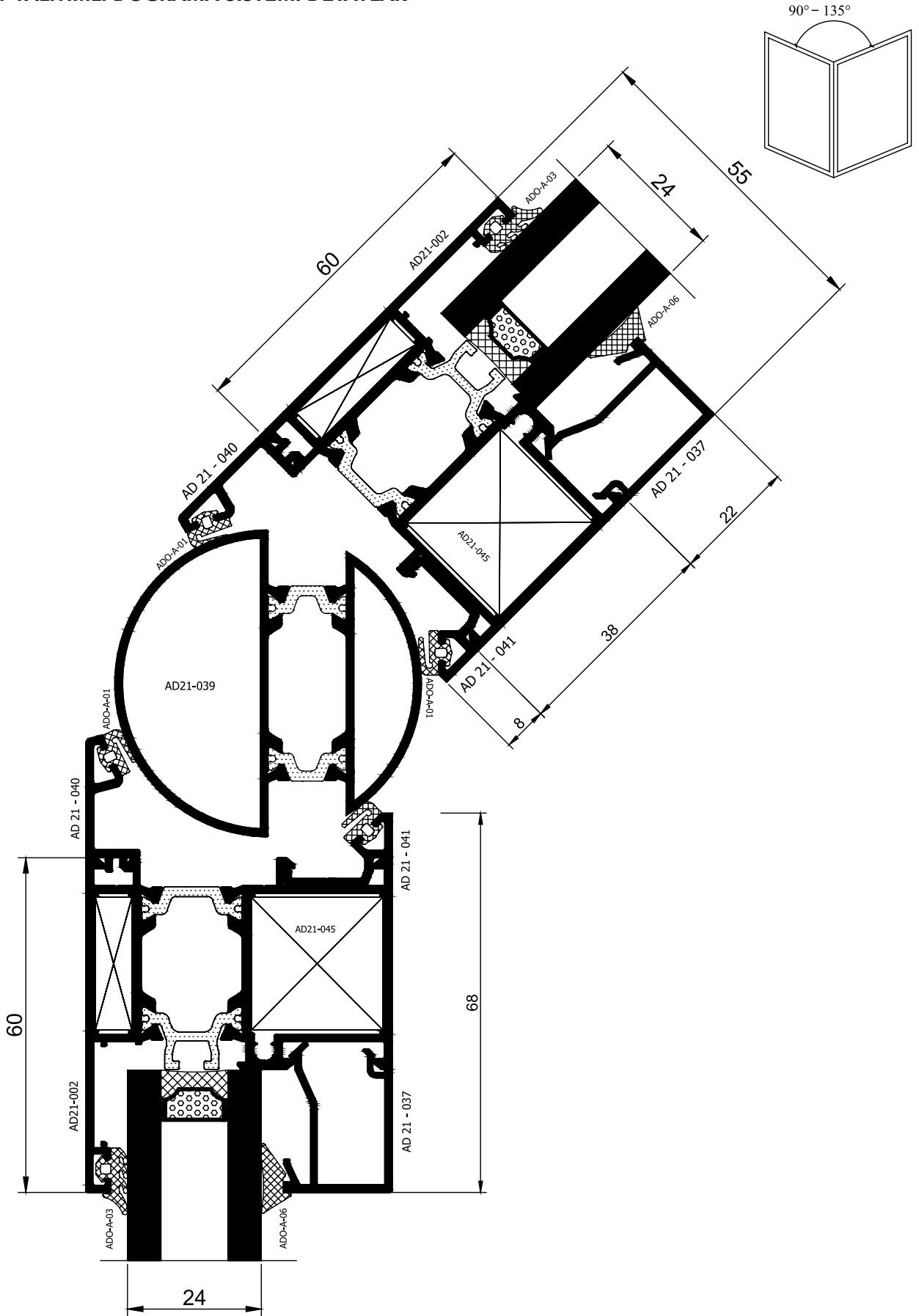



AD 55 T YALITIMLI DOĞRAMA SİSTEMİ DETAYLAR

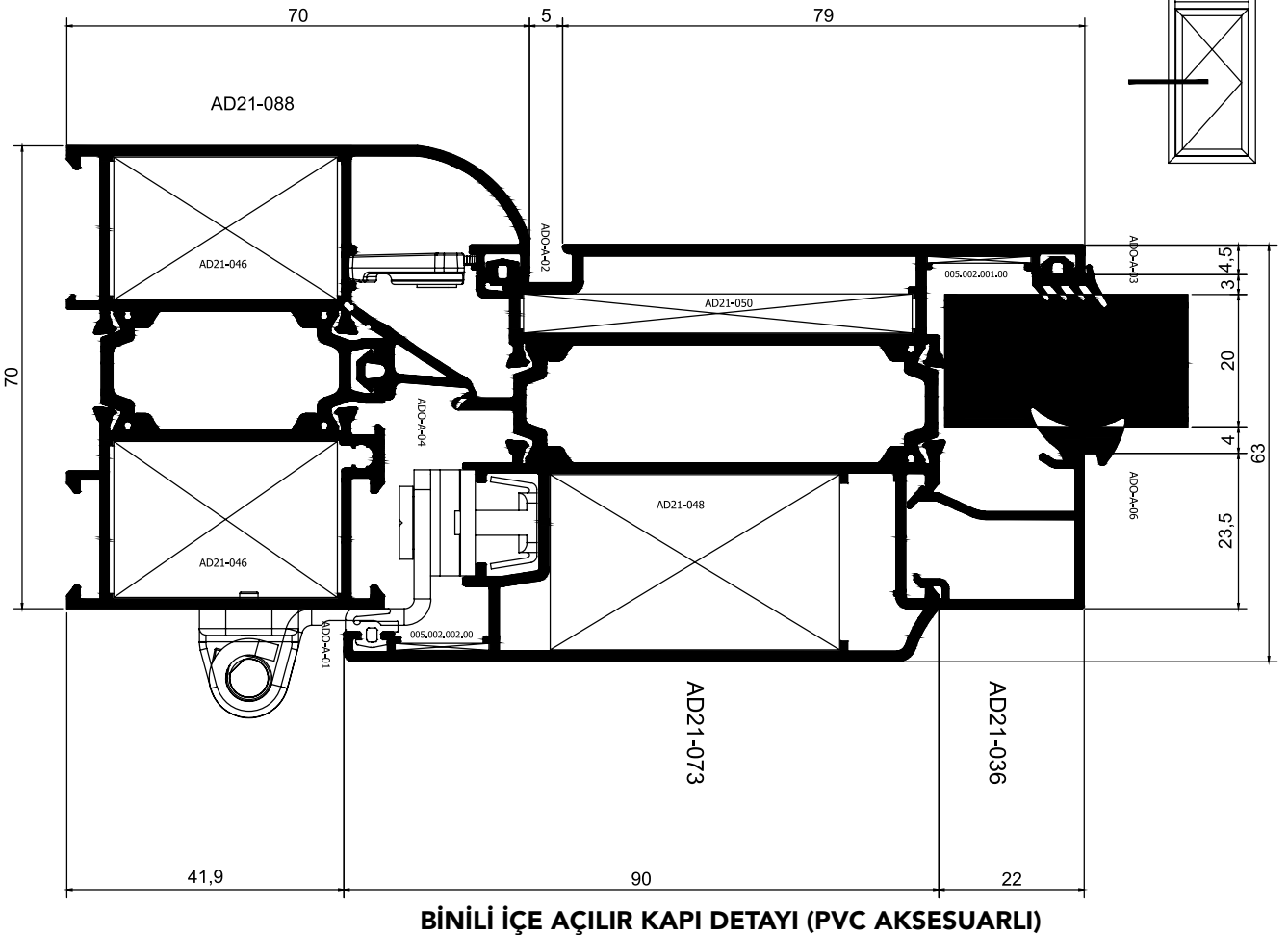
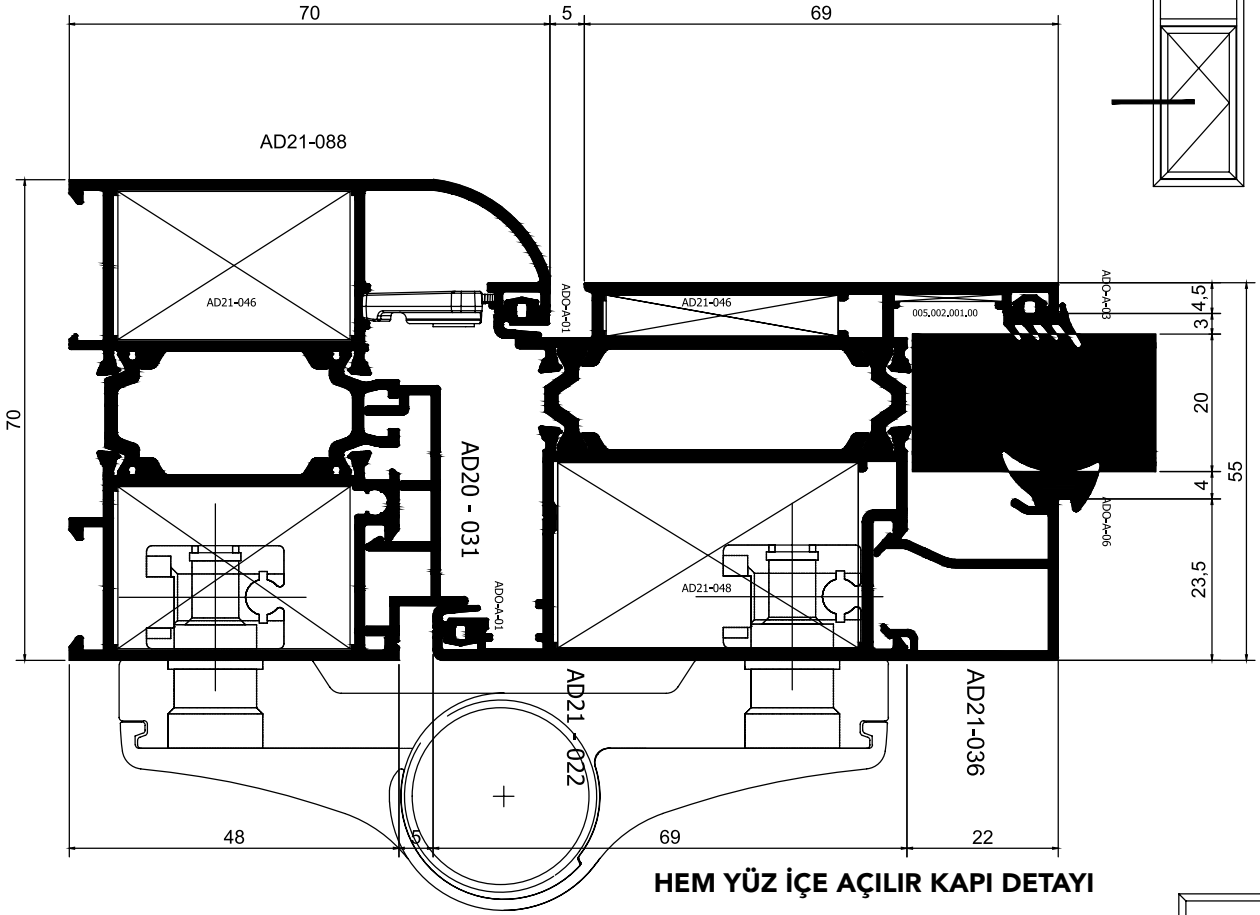

## AD 55 T YALITIMLI DOĞRAMA SİSTEMİ DETAYLAR DIŞA AÇILIM KAPI DETAYLARI

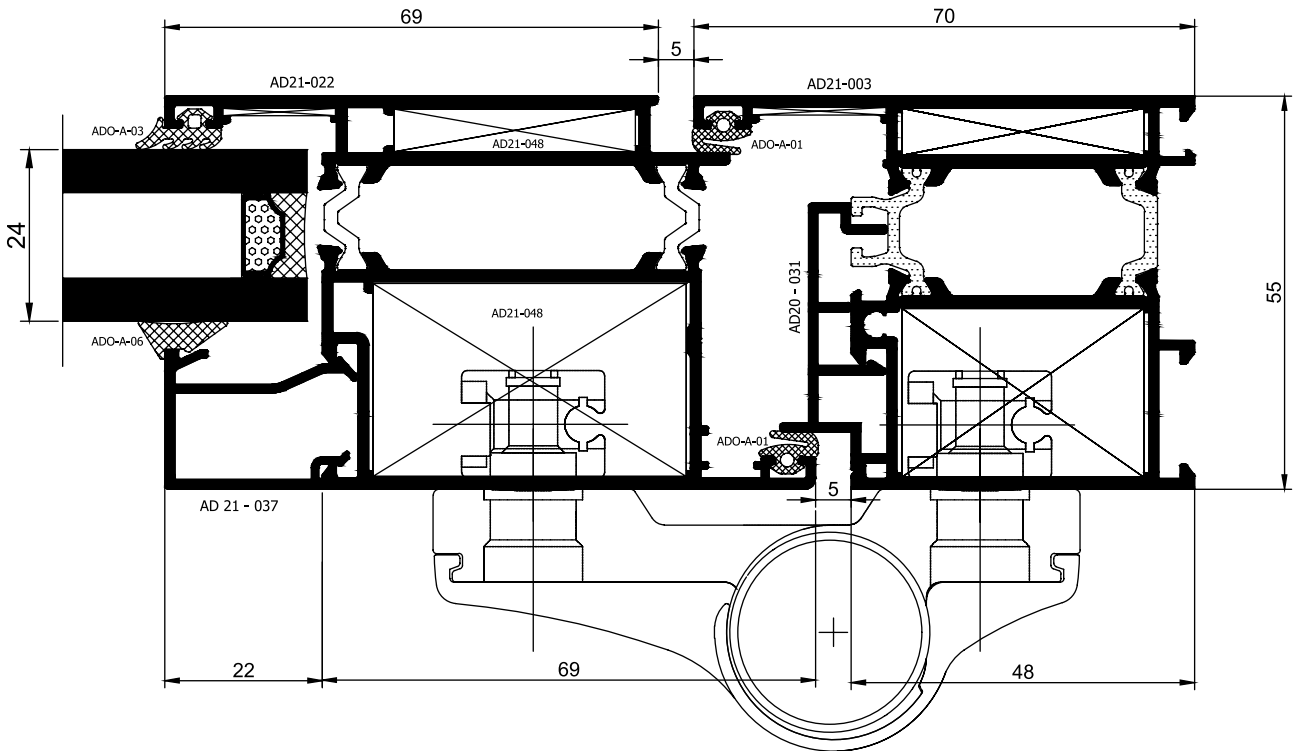
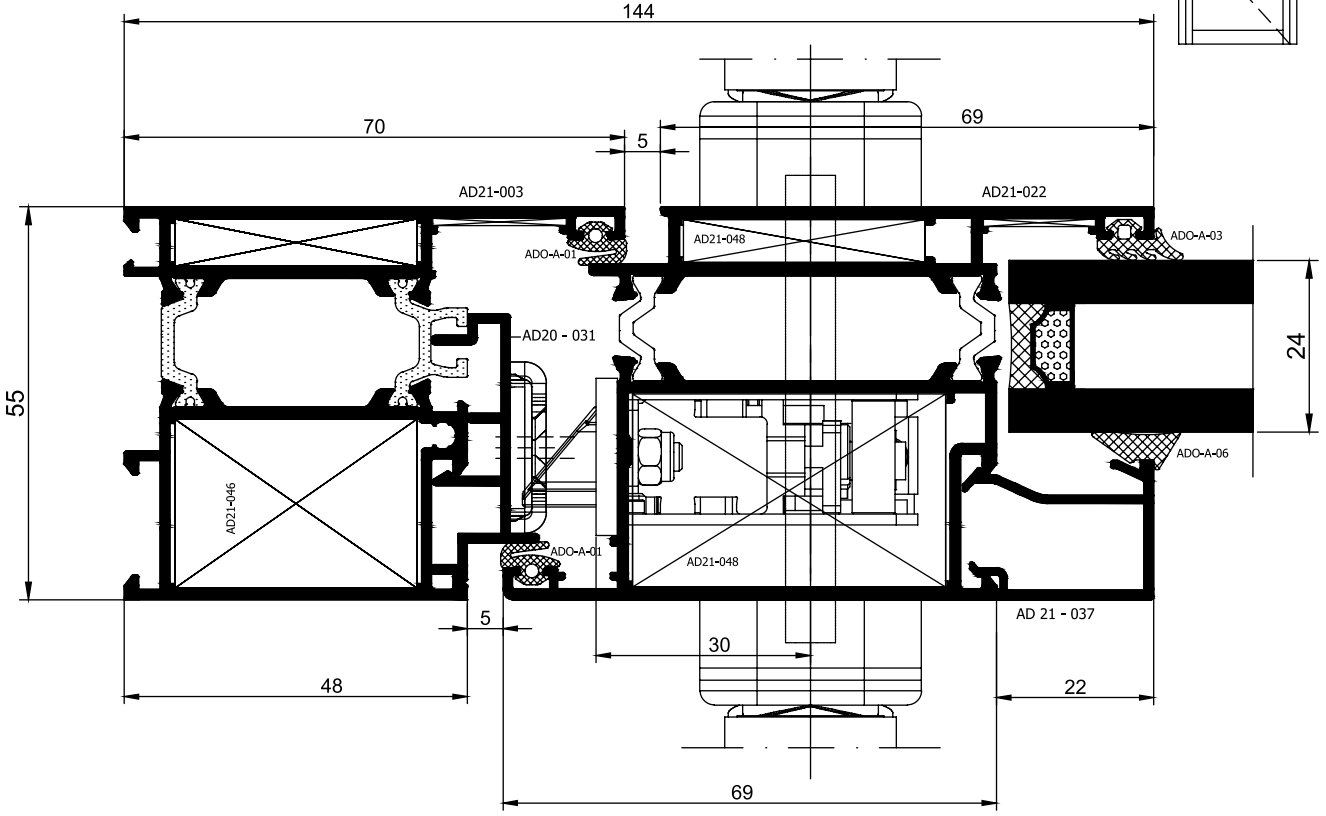
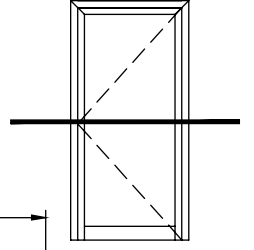



## AD 55 T YALITIMLI DOĞRAMA SİSTEMİ DETAYLAR DIŞA AÇILIM KAPI DETAYLARI

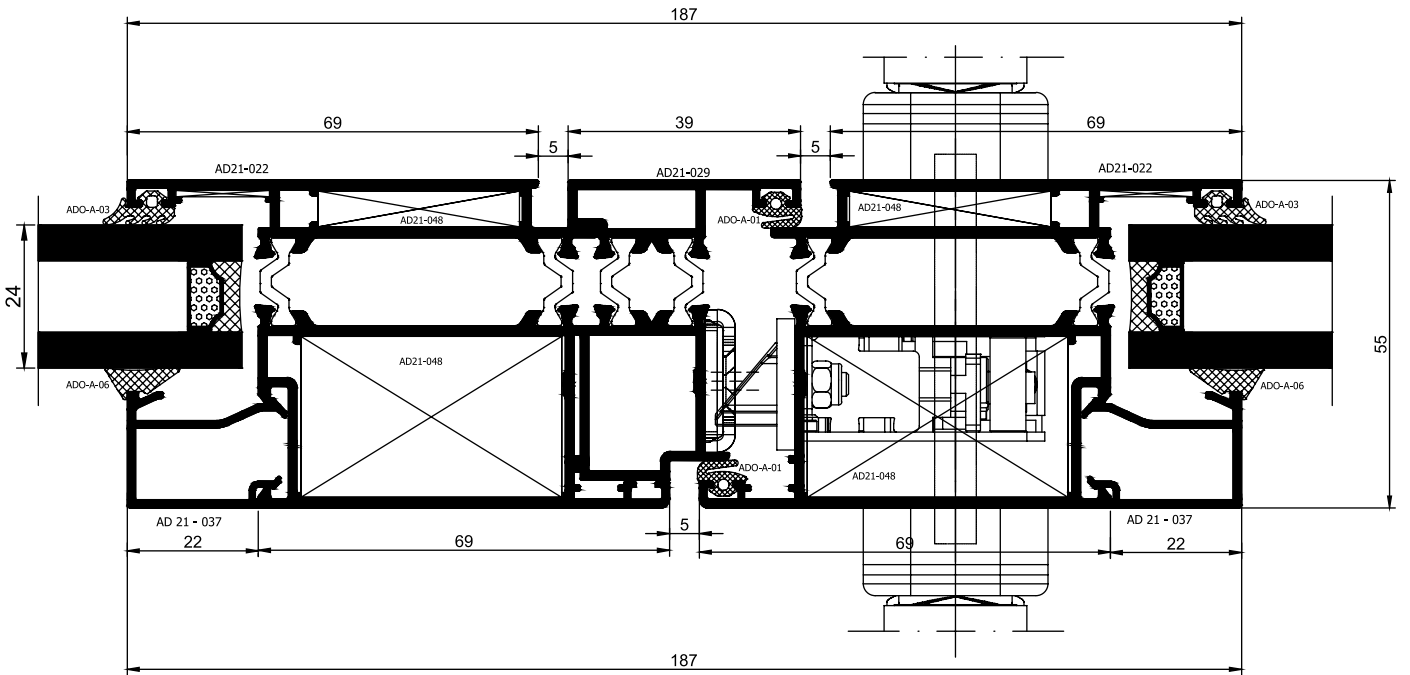
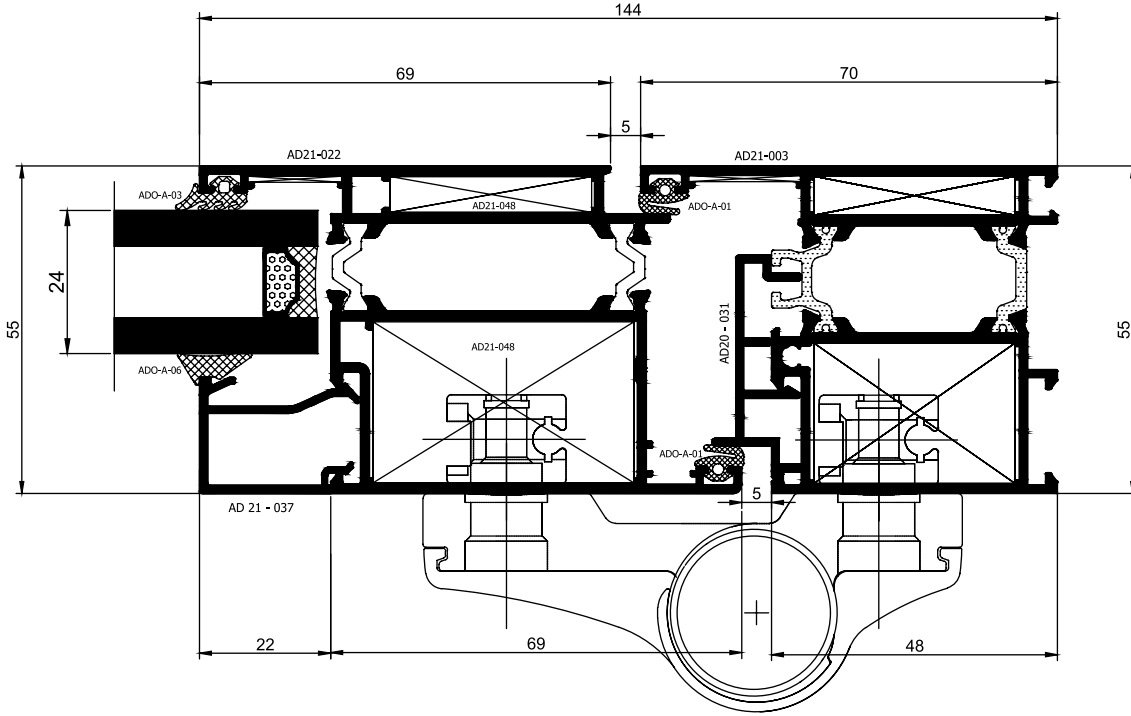
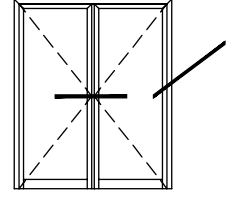

## AD 55 T YALITIMLI DOĞRAMA SİSTEMİ DETAYLAR DIŞA AÇILIM KAPI DETAYLARI

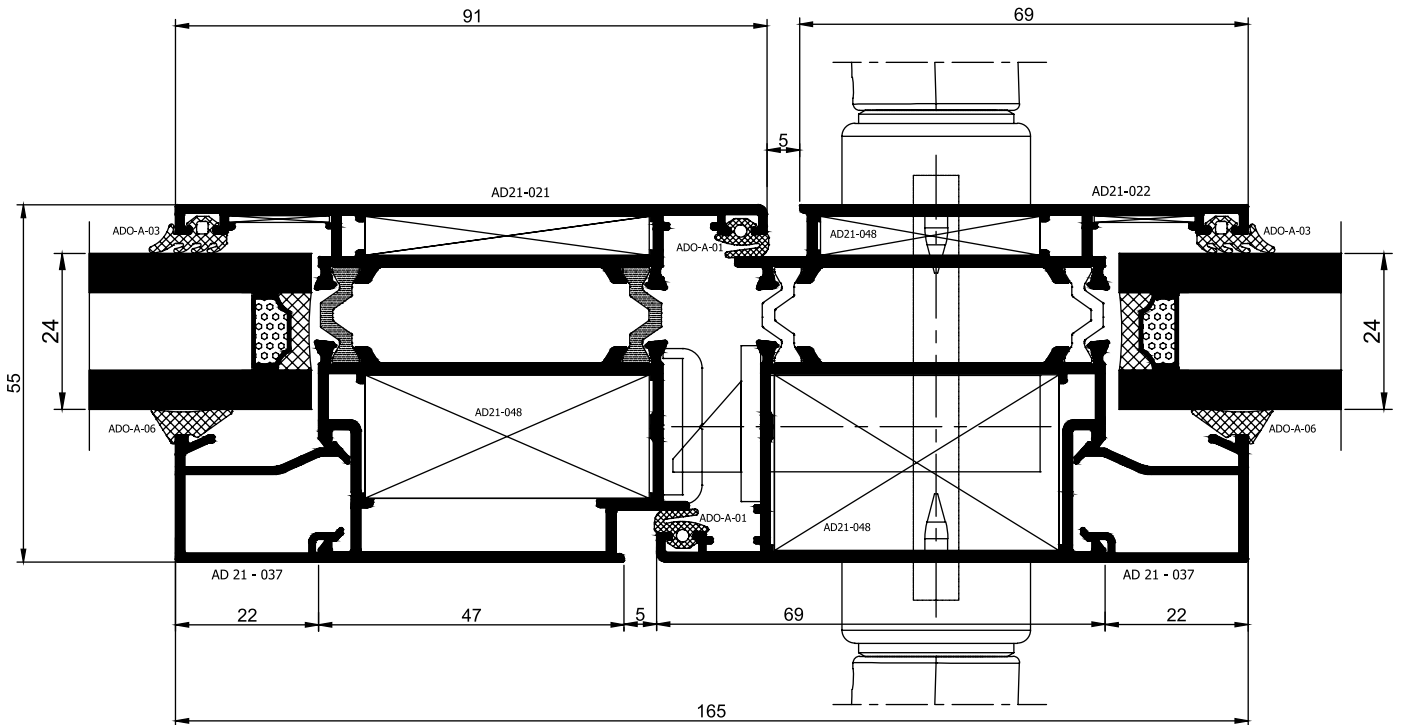
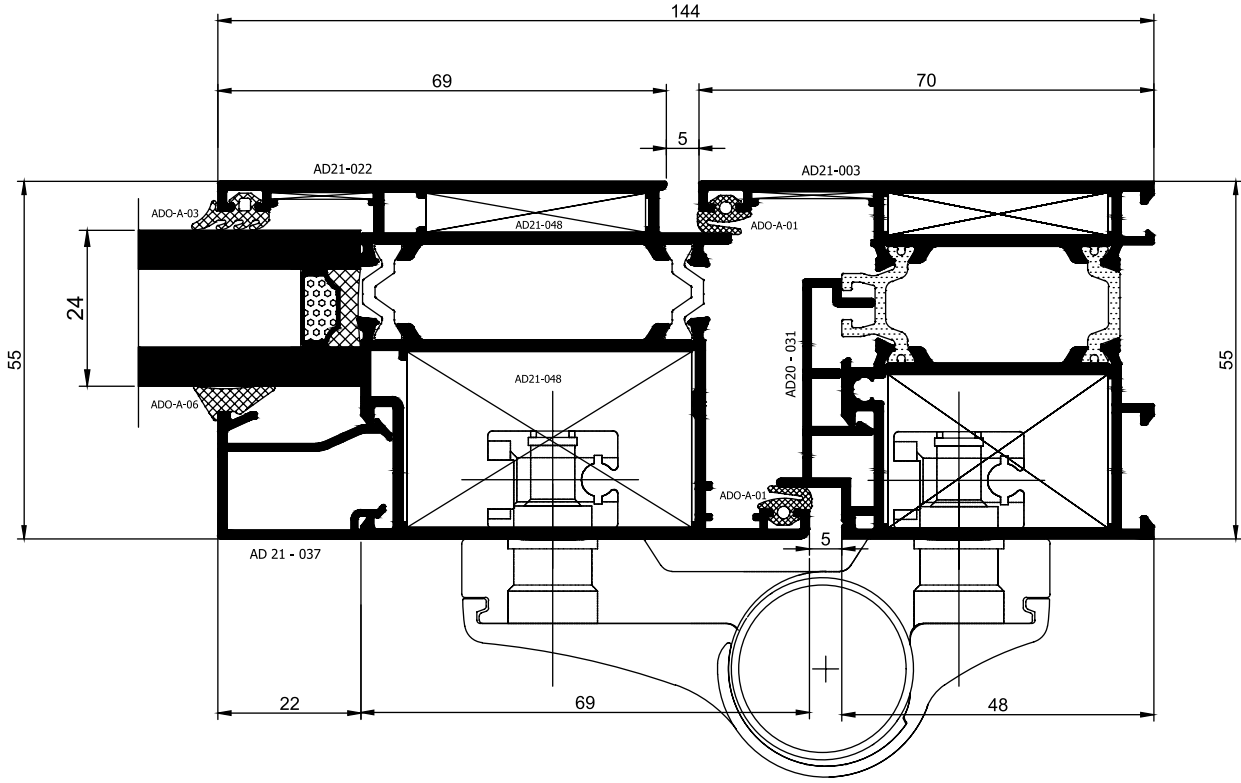
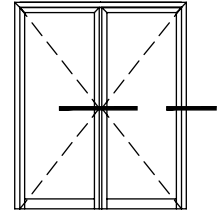



## AD 55 T YALITIMLI DOĞRAMA SİSTEMİ DETAYLAR DIŞA AÇILIM KAPI DETAYLARI

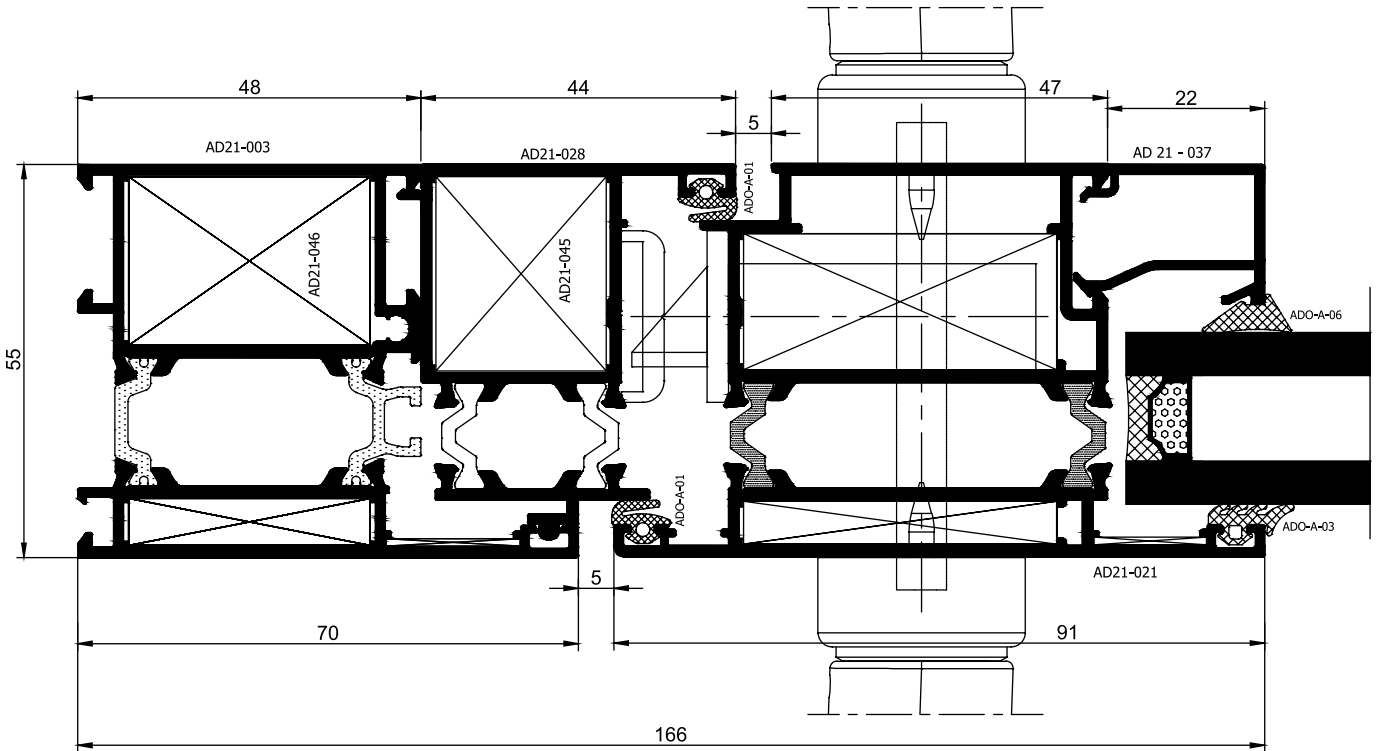
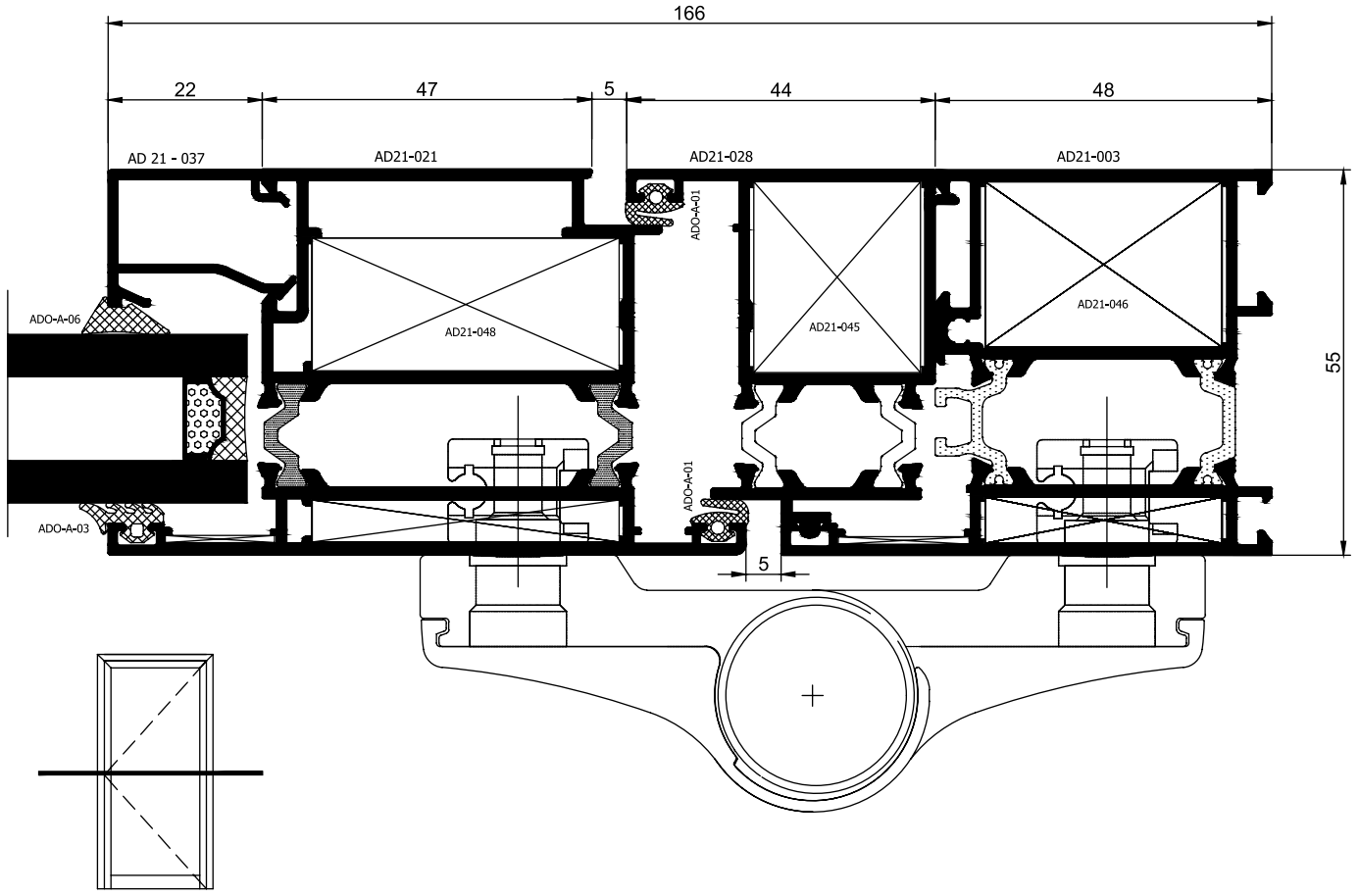

AD 55 T YALITIMLI DOĞRAMA SİSTEMİ DETAYLAR  
DİŞA AÇILIM KAPI DETAYLARI

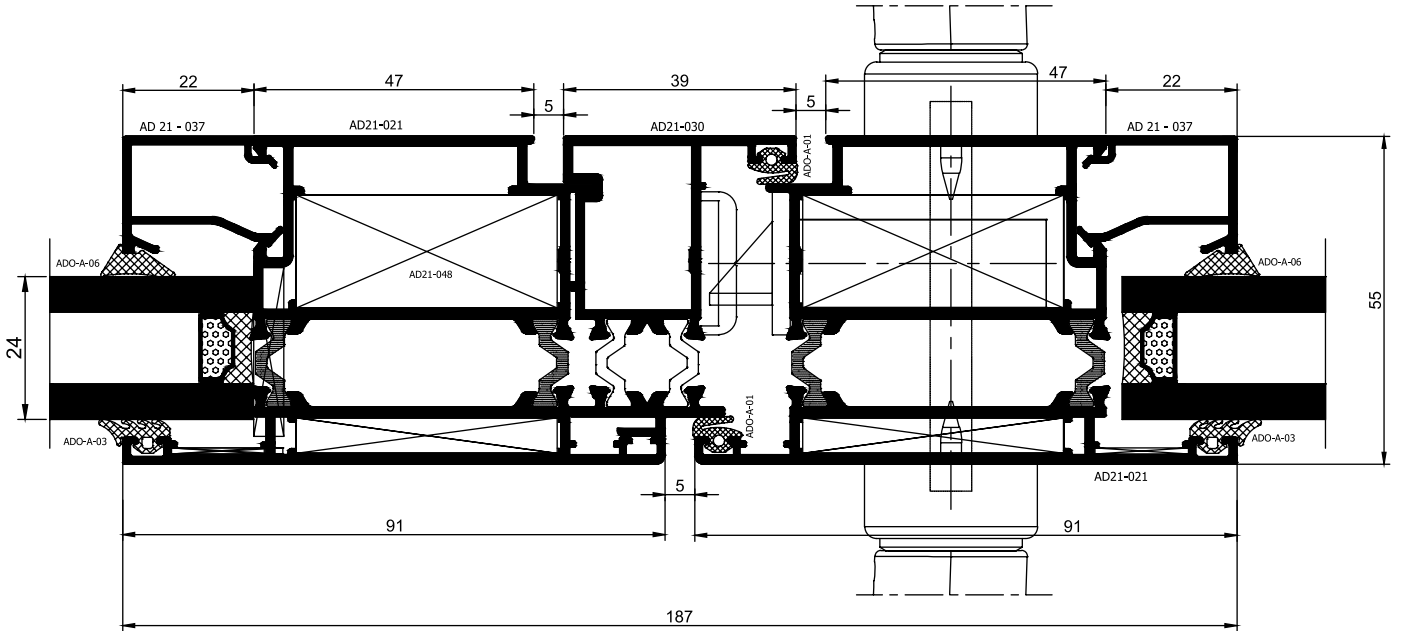
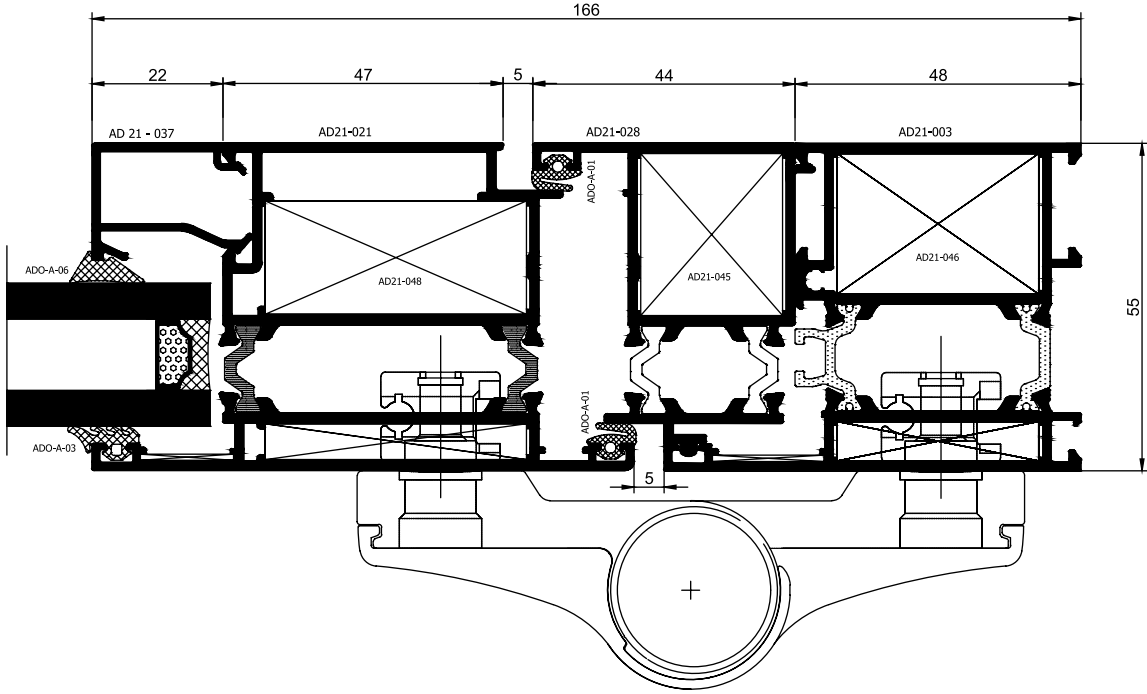

## AD 55 T YALITIMLI DOĞRAMA SİSTEMİ DETAYLAR DIŞA AÇILIM KAPI DETAYLARI

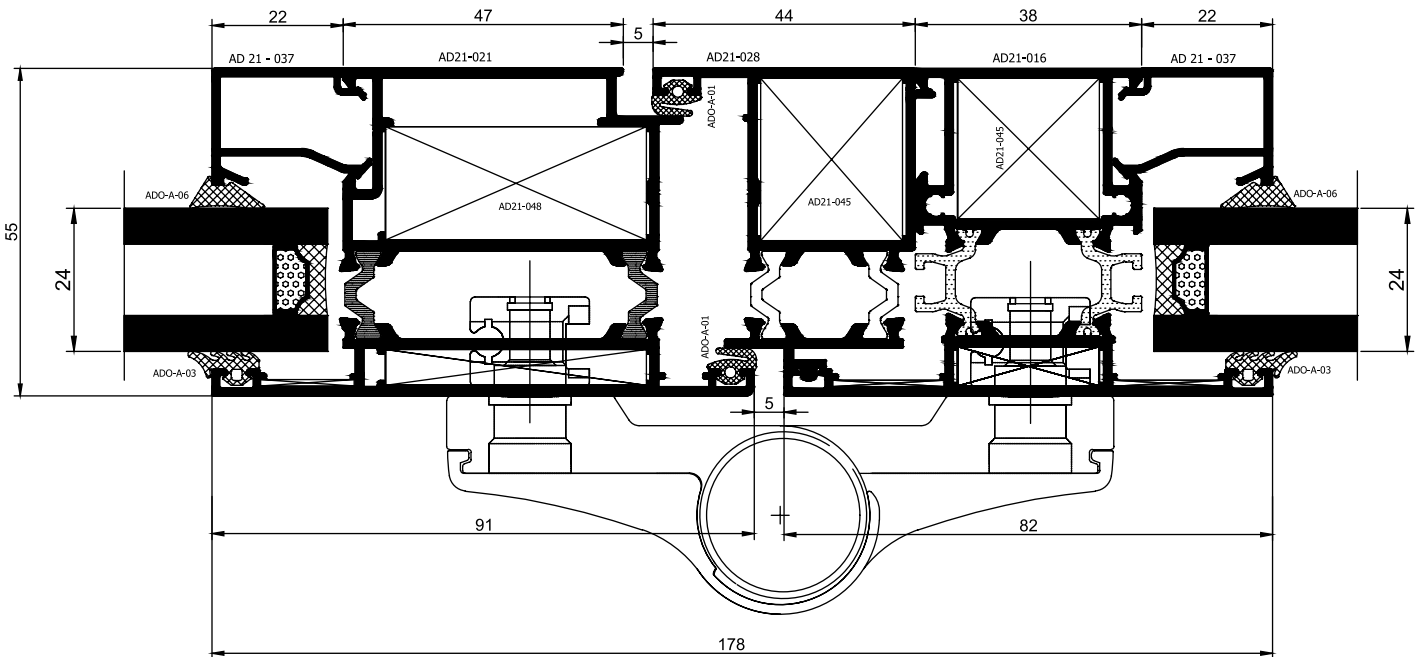
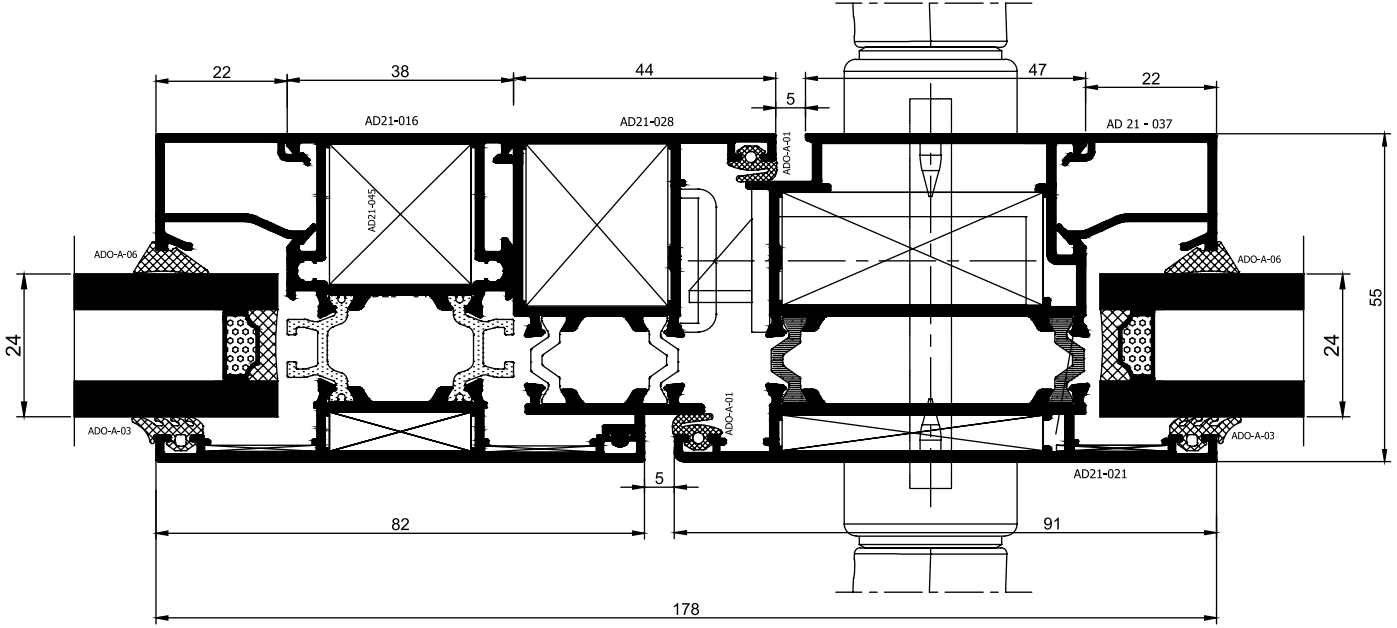
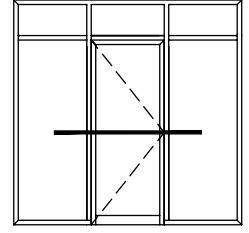

## AD 55 T YALITIMLI DOĞRAMA SİSTEMİ DETAYLAR DIŞA AÇILIM PENCERE DETAYLARI

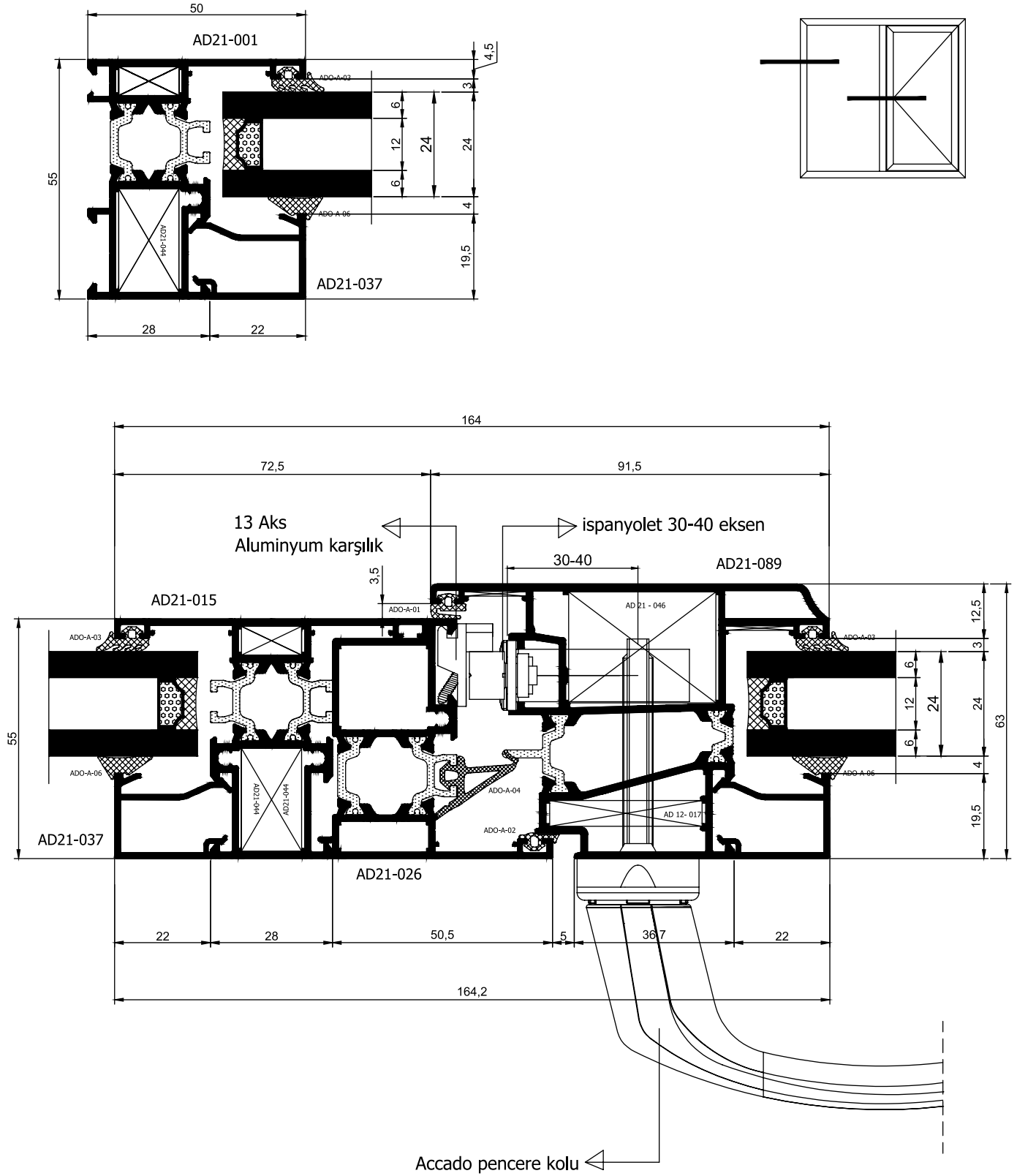

## AD 55 T YALITIMLI DOĞRAMA SİSTEMİ DETAYLAR DIŞA AÇILIM PENCERE DETAYLARI

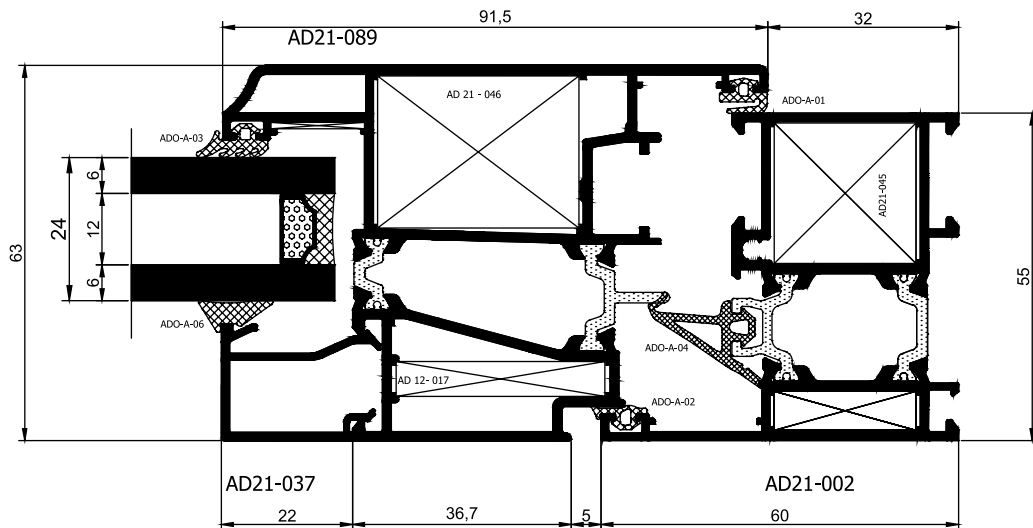
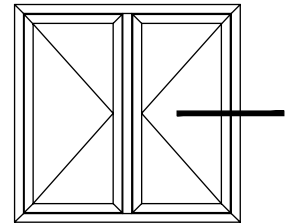
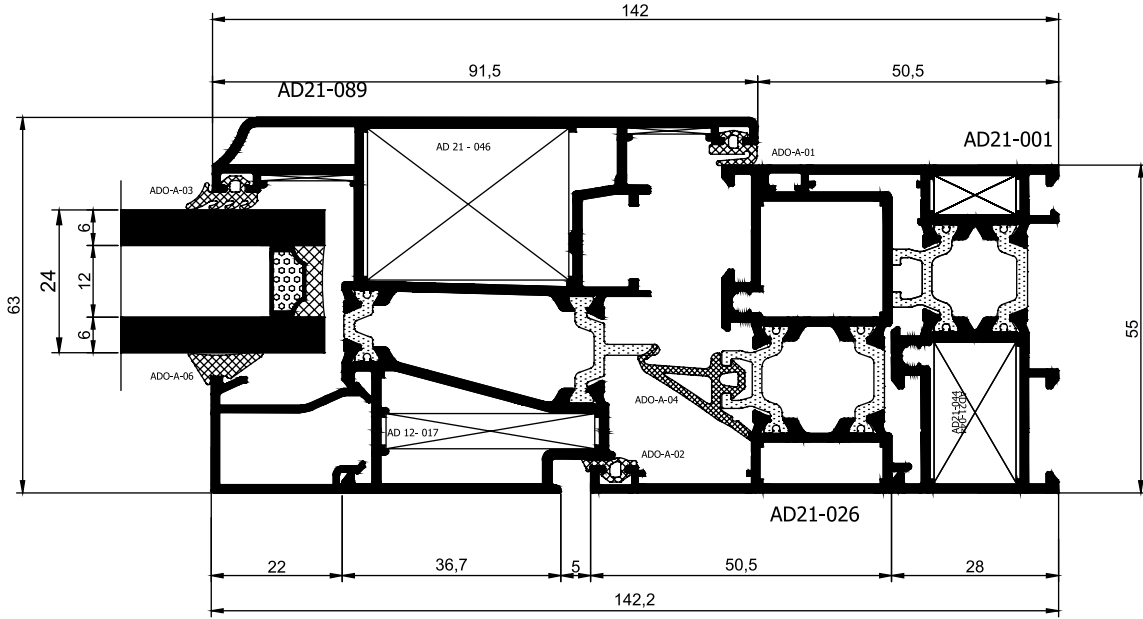
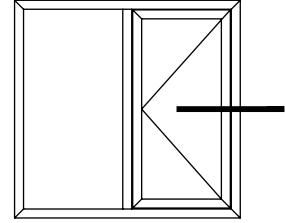



## AD 55 T YALITIMLI DOĞRAMA SİSTEMİ DETAYLAR DIŞA AÇILIM PENCERE DETAYLARI

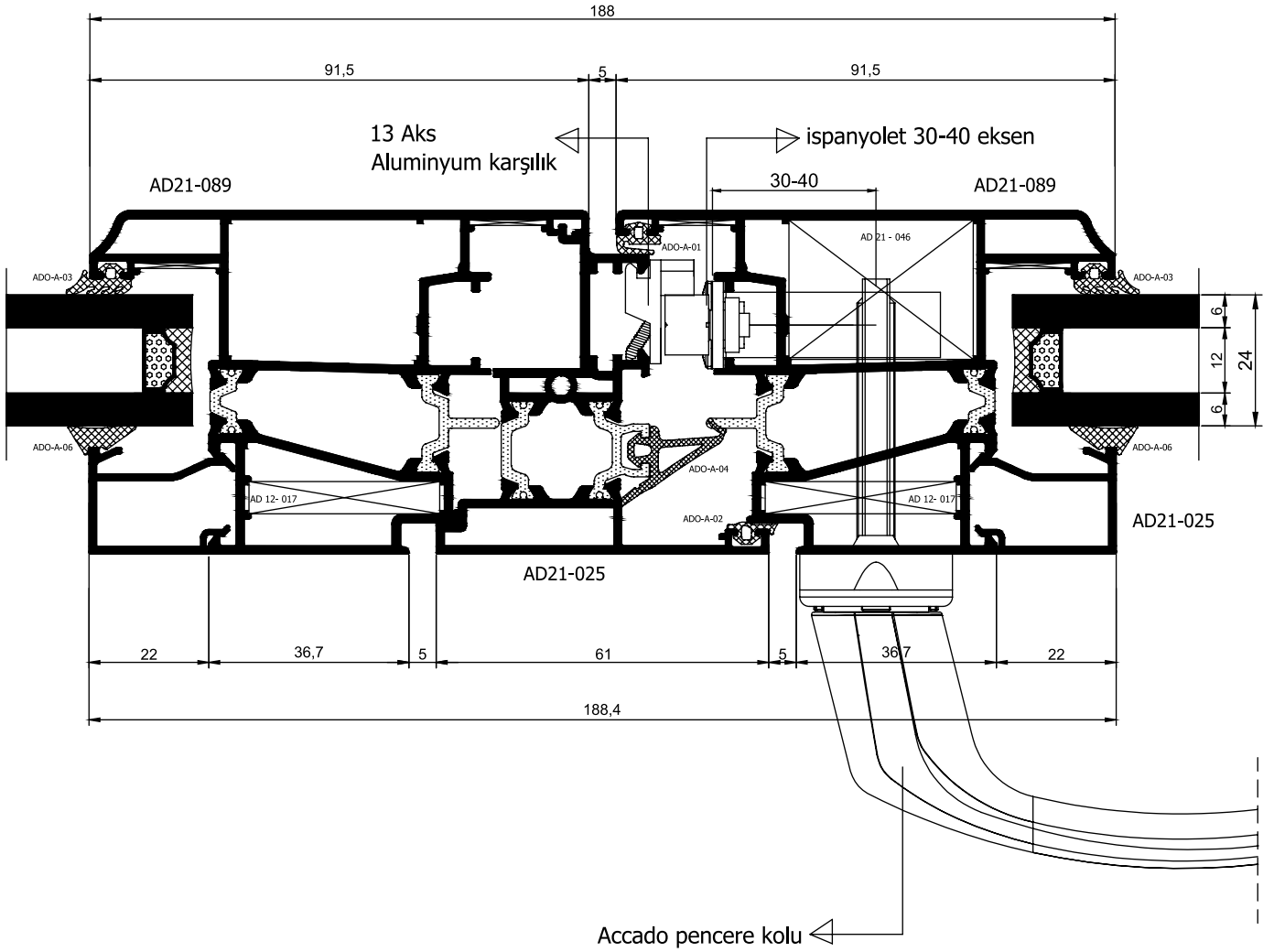
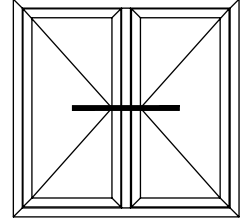





# ADO Alüminyum

[www.adoaluminyum.com.tr](http://www.adoaluminyum.com.tr)

## FABRİKA

Antalya Organize Sanayi Bölgesi 2.Kısım Mah. 21.Cadde No:3 07040 Döşemealtı / ANTALYA  
Tel : +90 242 236 40 00 · Faks : +90 242 236 40 90 · Email : [info@adoaluminyum.com.tr](mailto:info@adoaluminyum.com.tr)