

ADO Alüminyum

AD 61 T YALITIMLI DOĞRAMA SİSTEMİ

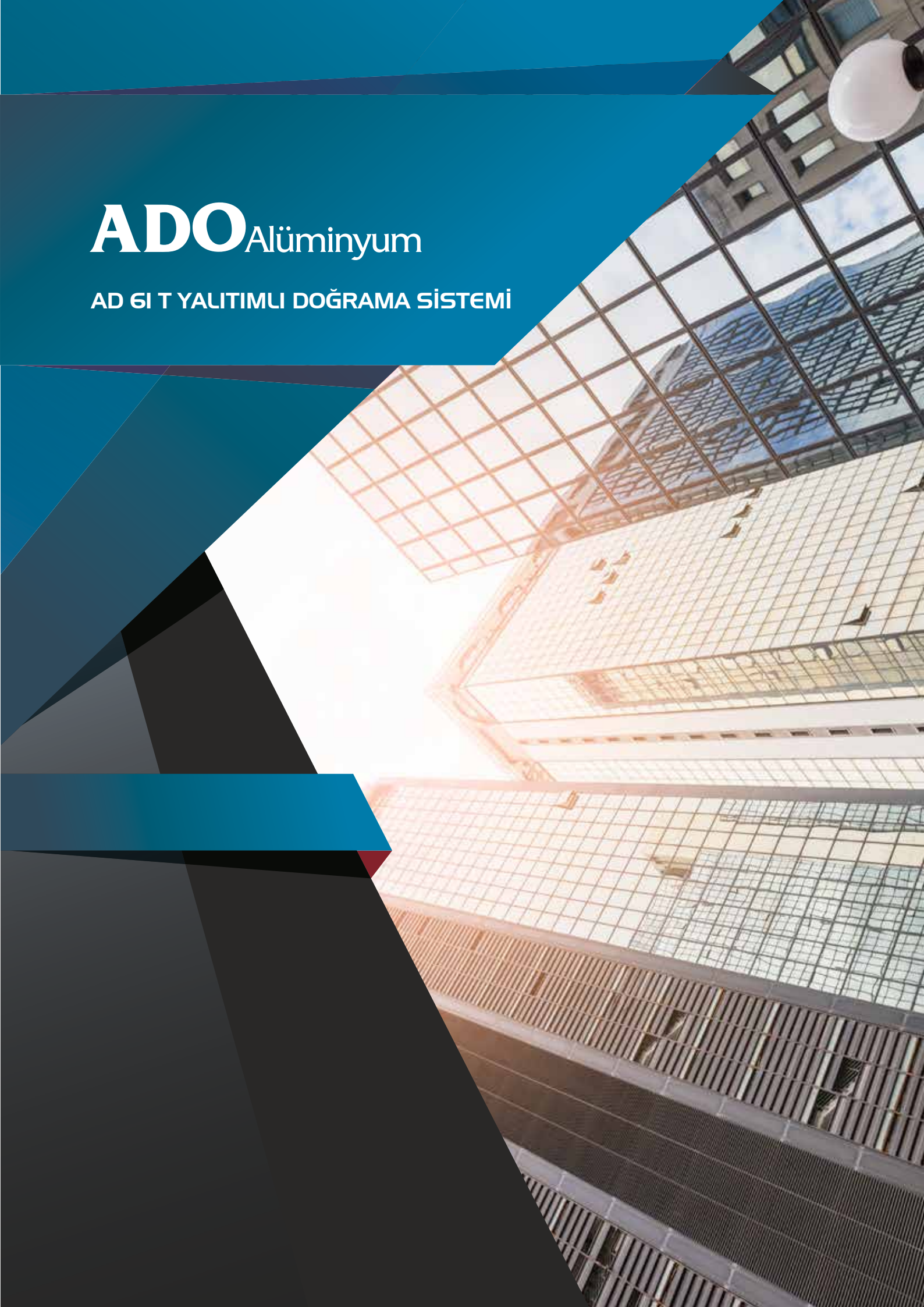



AD 61 T YALITIMLI DOĞRAMA SİSTEMİ PROFİLLERİ

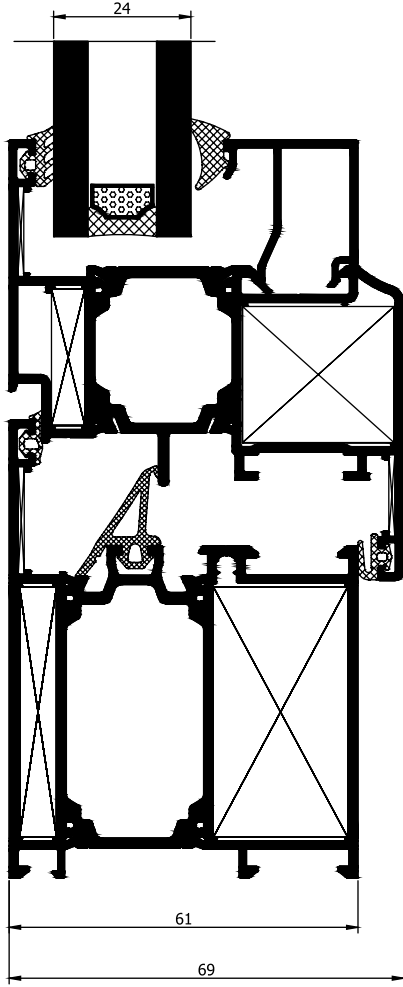

Alüminyum profiller AIMgSi 0,5 - F22 alaşımından ve 12020 Standartlarına göre üretilir.

Fiziksel Özellikler :

1- Yoğunluk	: 2,71 kg /dm ³
2- Elastisite Modülü	: 69 kN /mm ²
3- Direnç	: 20° 33 n Ω .m
4- Erime Noktası	: 600 - 655 °
5 - Genleşme Katsayısı	: 20 - 100° C μ °C ⁺¹

Mekanik Özellikler :

1- Elastisite Limiti	: 190 MPa
2 - Kopma dayanıklılığı	: 220 MPa
3- Sertlik	: 67 Brinell
4- Uzama	: % 10

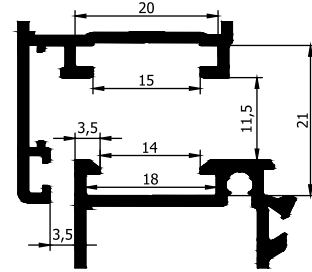

EURO KANAL TİP 1

SİSTEM BİLGİLERİ :

Profil Genişlik : Kasa 61 mm - Kanat 69 mm

Isı Bariyer Ölçüsü : 24 mm

Isı Geçirgenlik değeri (Uf) : 2.002 W/m²K

Fitil (Conta) : Tüm fitiller Kaucuk Özellikli EPDM dir.



Yapılabilir Pencere Tipleri : İçe açılır - Çift açılır - Çift Kanat açılır - Woswagen Pencere - pencere tipleri ile İçe açılır Kapı - Dışa açılı Kapılar.

Kullanılabilir Cam Kalınlığı : 10 mm Tek cam dan 40 mm Isıcam kalınlığına kadar EPDM fitil kalınlıkları ve ölçüsüne uygun cam çitası ile ayarlanak istenilen ısıcam kullanım imkanı sunmaktadır.

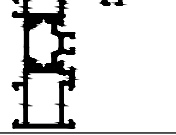
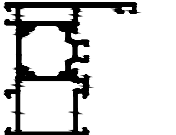
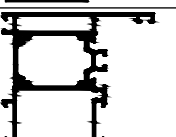

Su Tahliye : Bütün Profiller Su tahliye sistemine sahiptir.

Bağlantılar : Köşe birleşimlerini sağlamak için Pres Köşe takoz bağlantıları ve Çene L parçaları kullanarak preslenir. Orta Kayıtlar dış kasadan vida atılarak ve iç kısımdan takozları ile bağlanır.

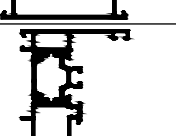
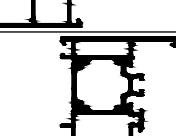
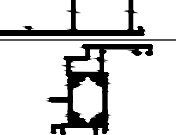
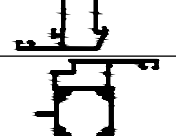
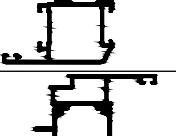
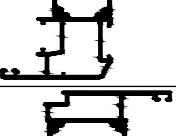
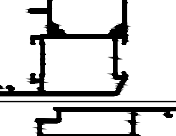
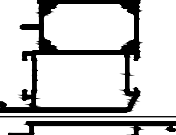
AD 61 T YALITIMLI DOĞRAMA SİSTEMİ PROFİLLERİ

No:	Profil Şekli	Profil Kod	Profil Adı	Profil Ağırlık (Kg/m)		
1		AD31-001	KASA PROFİLİ	1,193 Kg/m		
2		AD31-002	KASA PROFİLİ	1,356 Kg/m		
3		AD31-003	KASA PROFİLİ	1,518 Kg/m		
4		AD31-004	KASA PROFİLİ	1,728 Kg/m		
5		AD31-005	PERVAZLI KASA PROFİLİ	1,293 Kg/m		
6		AD31-006	PERVAZLI KASA PROFİLİ	1,573 Kg/m		
7		AD31-007	KANAT PROFİLİ	1,309 Kg/m		
8		AD31-008	KANAT PROFİLİ	1,471 Kg/m		
9		AD31-009	PVC AKSESUAR UYUMLU KANAT PROFİLİ	1,491 Kg/m		
10		AD31-010	KANAT PROFİLİ	1,682 Kg/m		
11		AD31-011	KANAT PROFİLİ	1,850 Kg/m		
12		AD31-012	KANAT PROFİLİ	2,101 Kg/m		

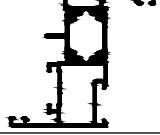
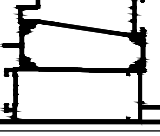
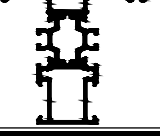
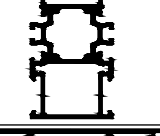
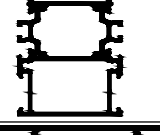
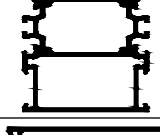
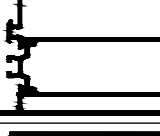
AD 61 T YALITIMLI DOĞRAMA SİSTEMİ PROFİLLERİ

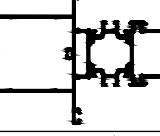
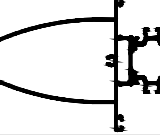
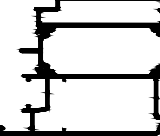
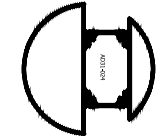
No:	Profil Şekli	Profil Kod	Profil Adı	Profil Ağırlık (Kg/m)		
13		AD31-013	KANAT PROFİLİ	1,251 Kg/m		
14		AD31-014	BİNİLİ DIŞA AÇILIM KANAT PROFİLİ	2,267 Kg/m		
15		AD31-015	ORTA KAYIT PROFİLİ	1,345 Kg/m		
16		AD31-016	ORTA KAYIT PROFİLİ	1,537 Kg/m		
17		AD31-017	ORTA KAYIT PROFİLİ	1,671 Kg/m		
18		AD31-018	ORTA KAYIT PROFİLİ	1,885 Kg/m		
19		AD31-019	ORTA KAYIT PROFİLİ	2,441 Kg/m		
20		AD31-020	ETEK PROFİLİ	2,562 Kg/m		
21		AD31-021	TAKVİYELİ ORTA KAYIT PROFİLİ	2,173 Kg/m		
22		AD31-022	TAKVİYELİ ORTA KAYIT PROFİLİ	2,339 Kg/m		
23		AD31-023	PVC AKSESUAR UYUMLU KANAT PROFİLİ	2,116 Kg/m		
24		AD31-024	KÖŞE PROFİLİ	1,076 Kg/m		

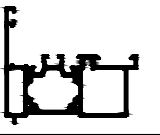
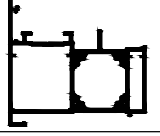
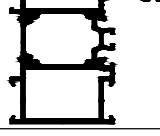
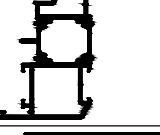
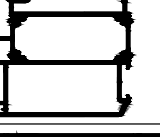
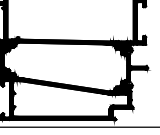
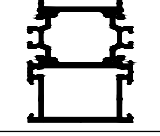
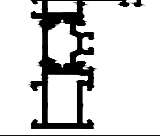
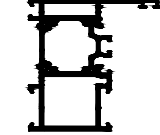
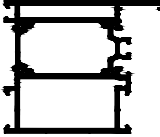
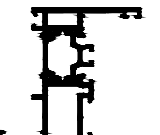

AD 61 T YALITIMLI DOĞRAMA SİSTEMİ PROFİLLERİ

No:	Profil Şekli	Profil Kod	Profil Adı	Profil Ağırlık (Kg/m)		
25		AD31-025	BİNİLİ KANAT ORTA ADAPTÖR PROFİLİ	1,269 Kg/m		
26		AD31-026	BİNİLİ DIŞA AÇILIM KANAT KASA ADAPTÖR PROFİLİ	1,176 Kg/m		
27		AD31-027	PİVOT PENCERE ADAPTÖRÜ	1,351 Kg/m		
28		AD31-030	KASA PROFİLİ (2 mm)	1,813 Kg/m		
29		AD31-031	KANAT PROFİLİ (2 mm)	1,746 Kg/m		
30		AD31-032	KANAT PROFİLİ (2 mm)	2,485 Kg/m		
31		AD31-033	BİNİLİ DIŞA AÇILIM KANAT PROFİLİ (2 mm)	2,708 Kg/m		
32		AD31-034	ORTA KAYIT PROFİLİ (2 mm)	1,985 Kg/m		
33		AD31-035	KASA PROFİLİ (2 mm)	1,387 Kg/m		
34		AD31-036	KASA PROFİLİ (2 mm)	1,602 Kg/m		
35		AD31-037	KASA PROFİLİ (2 mm)	2,024 Kg/m		
36		AD31-038	PERVAZLI KASA PROFİLİ (2 mm)	1,517 Kg/m		

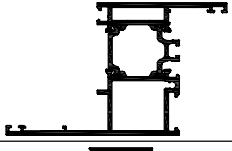
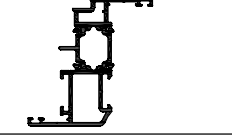
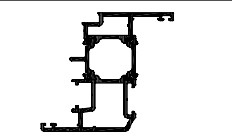
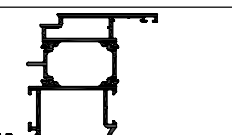
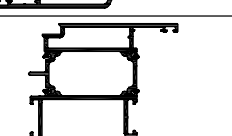
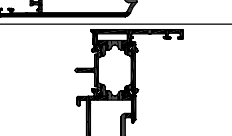
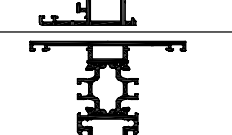
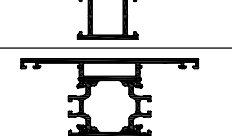
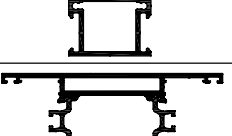
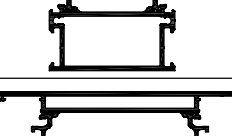
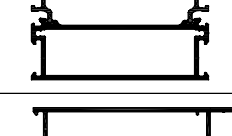
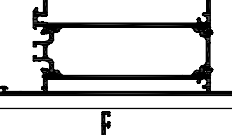



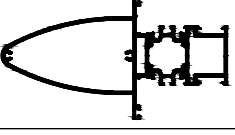
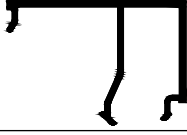
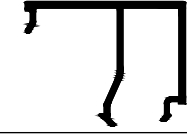
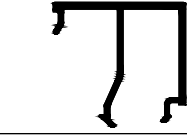
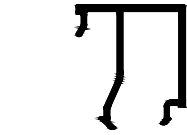
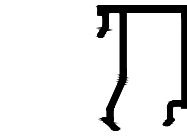
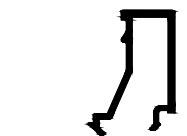
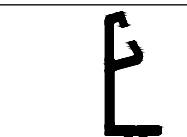
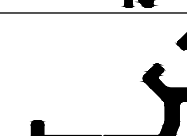

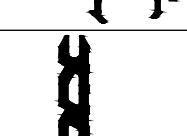
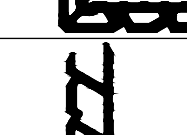

AD 61 T YALITIMLI DOĞRAMA SİSTEMİ PROFİLLERİ

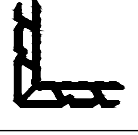
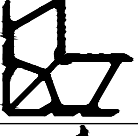
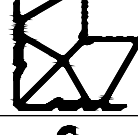
No:	Profil Şekli	Profil Kod	Profil Adı	Profil Ağırlık (Kg/m)		
37		AD31-039	PERVAZLI KASA PROFİLİ (2 mm)	1,845 Kg/m		
38		AD31-040	KANAT PROFİLİ (2 mm)	1,537 Kg/m		
39		AD31-041	PVC AKS. UYUMLU KANAT PROFİLİ (2 mm)	1,757 Kg/m		
40		AD31-042	KANAT PROFİLİ (2 mm)	1,957 Kg/m		
41		AD31-043	KANAT PROFİLİ (2 mm)	2,168 Kg/m		
42		AD31-044	KANAT PROFİLİ (2 mm)	1,459 Kg/m		
43		AD31-045	ORTA KAYIT PROFİLİ (2 mm)	1,562 Kg/m		
44		AD31-046	ORTA KAYIT PROFİLİ (2 mm)	1,774 Kg/m		
45		AD31-047	ORTA KAYIT PROFİLİ (2 mm)	2,196 Kg/m		
46		AD31-048	ORTA KAYIT PROFİLİ (2 mm)	2,831 Kg/m		
47		AD31-049	ETEK PROFİLİ (2 mm)	2,954 Kg/m		
48		AD31-050	TAKVİYELİ ORTA KAYIT PROFİLİ (2 mm)	2,617 Kg/m		

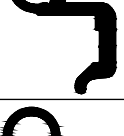

AD 61 T YALITIMLI DOĞRAMA SİSTEMİ PROFİLLERİ

No:	Profil Şekli	Profil Kod	Profil Adı	Profil Ağırlık (Kg/m)		
49		AD31-051	TAKVİYELİ ORTA KAYIT PROFİLİ (2 mm)	2,836 Kg/m		
50		AD21-033	TEK CAM ÇITA PROFİLİ	0,350 Kg/m		
51		AD21-034	TEK CAM ÇITA PROFİLİ	0,335 Kg/m		
52		AD21-035	ISICAM ÇITA PROFİLİ	0,312 Kg/m		
53		AD21-036	ISICAM ÇITA PROFİLİ	0,295 Kg/m		
54		AD21-037	ISICAM ÇITA PROFİLİ	0,278 Kg/m		
55		AD21-038	ISICAM ÇITA PROFİLİ	0,247 Kg/m		
56		AD21-040	ÇITA PROFİLİ	0,179 Kg/m		
57		AD21-041	ÇITA PROFİLİ	0,140 Kg/m		
58		AD21-087	ISICAM ÇITA PROFİLİ	0,252 Kg/m		
59		AD21-044	KÖŞE TAKOZU	3,030 Kg/m		
60		AD21-045	KÖŞE TAKOZU	3,566 Kg/m		





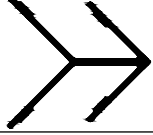
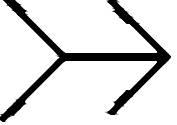
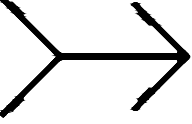
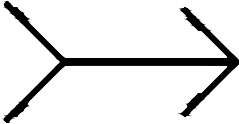
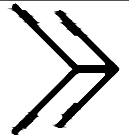
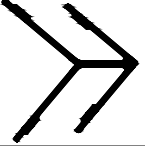



AD 61 T YALITIMLI DOĞRAMA SİSTEMİ PROFİLLERİ

No:	Profil Şekli	Profil Kod	Profil Adı	Profil Ağırlık (Kg/m)		
61		AD21-046	KÖŞE TAKOZU	4,157 Kg/m		
62		AD21-047	KÖŞE TAKOZU	3,220 Kg/m		
63		AD21-048	KÖŞE TAKOZU	5,307 Kg/m		
64		AD21-050	KÖŞE TAKOZU	6,366 Kg/m		
65		AD21-042	ORTA KAYIT BAĞLANTI PROFİLİ	0,327 Kg/m		
66		AD21-043	ORTA KAYIT BAĞLANTI PROFİLİ	0,347 Kg/m		
67		AD21-074	ORTA KAYIT BAĞLANTI PROFİLİ	0,507 Kg/m		
68		AD21-075	ORTA KAYIT BAĞLANTI PROFİLİ	0,444 Kg/m		
69		AD21-076	ORTA KAYIT BAĞLANTI PROFİLİ	0,423 Kg/m		
70		AD21-077	ORTA KAYIT BAĞLANTI PROFİLİ (SETSKURLU)	0,388 Kg/m		
71		AD21-080	MENTEŞE PROFİLİ	0,575 Kg/m		
72		AD21-081	MENTEŞE PROFİLİ	0,640 Kg/m		

AD 61 T YALITIMLI DOĞRAMA SİSTEMİ PROFİLLERİ

No:	Profil Şekli	Profil Kod	Profil Adı	Profil Ağırlık (Kg/m)		
73		AD16-029	PERVAZ PROFİLİ	1,092 Kg/m		
74		AD20-048	VİDALI KÖŞE BAĞLANTI PROFİLİ	1,079 Kg/m		
75		AD20-049	VİDALI KÖŞE BAĞLANTI PROFİLİ	1,176 Kg/m		
76		AD20-050	VİDALI KÖŞE BAĞLANTI PROFİLİ	1,271 Kg/m		
77		AD20-051	VİDALI KÖŞE BAĞLANTI PROFİLİ	1,415 Kg/m		
78		AD20-052	VİDALI KÖŞE BAĞLANTI PROFİLİ	0,984 Kg/m		
79		AD20-053	VİDALI KÖŞE BAĞLANTI PROFİLİ	1,016 Kg/m		
80		AD20-038	TİJ PROFİLİ	0,130 Kg/m		
81						
82						
83						
84						

AD 61 T YALITIMLI DOĞRAMA SİSTEMİ PROFİLLERİ

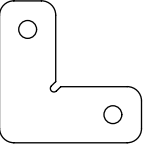
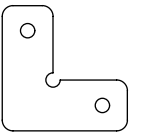
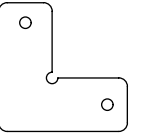
No:	Şekil	İsim	Kod	Koli Bilgileri			
				Mt	Kg		
1		EPDM İç Bini Fiteli	ADO-A-01 020.004.001.03	375	12		
2		EPDM Dış Bini Fiteli	ADO-A-02 020.005.001.03	571	12		
3		EPDM Dış Cam Fiteli	ADO-A-03 020.001.001.03	267	12		
4		EPDM Orta Fiteli	ADO-A-04 020.003.001.03	126	12		
5		EPDM Çıta Fiteli	ADO-A-05 020.002.001.03	197	12		
6		EPDM Çıta Fiteli	ADO-A-06 020.002.002.03	164	12		
7		EPDM Çıta Fiteli	ADO-A-07 020.002.003.03	197	12		
8		EPDM Çıta Fiteli	ADO-A-08 020.002.004.03	255	12		
9		EPDM Çıta Fiteli	ADO-A-09 020.002.005.03	240	12		
10		SAC KÖŞE GÖNYE 39,7x15,7	005.002.001.00				
11		SAC KÖŞE GÖNYE 35x14,2	005.002.002.00				
12		SAC KÖŞE GÖNYE 45x18,7	005.002.003.00				

AD 61 T YALITIMLI DOĞRAMA SİSTEMİ PROFİLLERİ

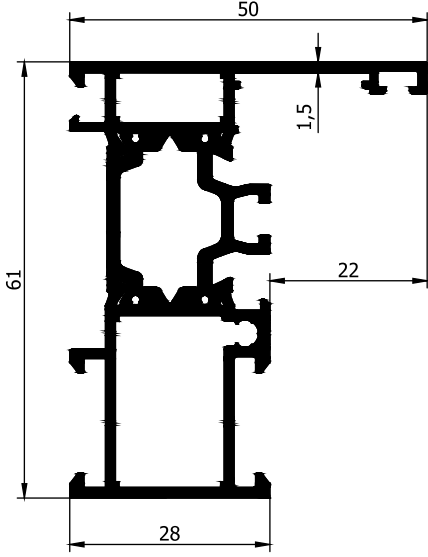

AD31-001
1,193 Kg/m

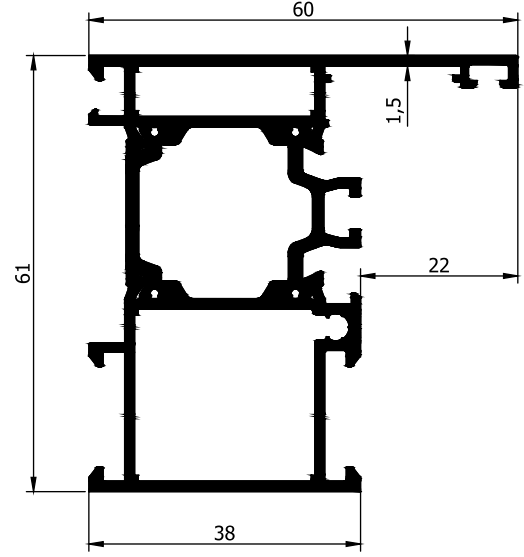

AD31-002
1,356 Kg/m

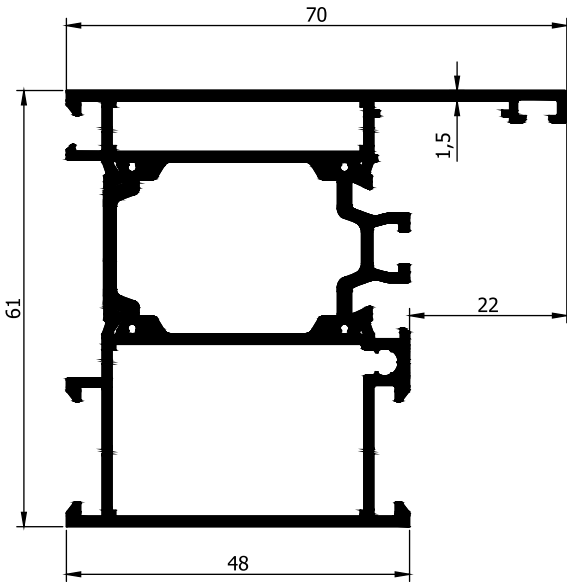

AD31-003
1,518 Kg/m

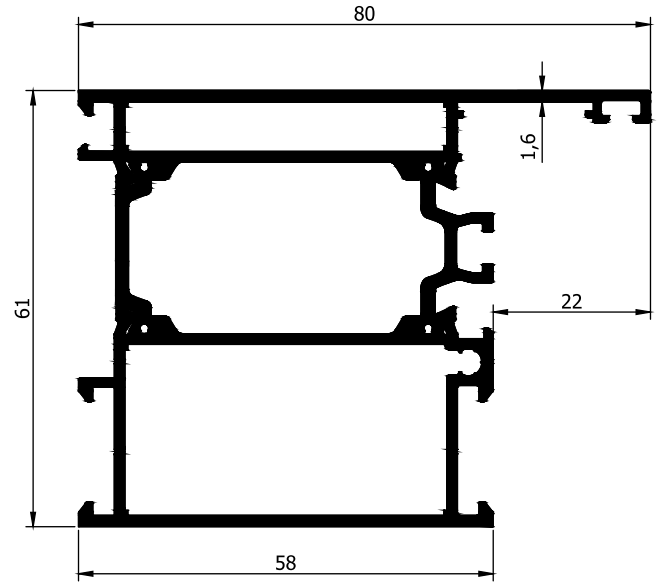

AD31-004
1,728 Kg/m

Uyarı: Profil ağırlıklarımız teorik olup; teslim anındaki tartımız geçerlidir.

AD 61 T YALITIMLI DOĞRAMA SİSTEMİ PROFİLLERİ

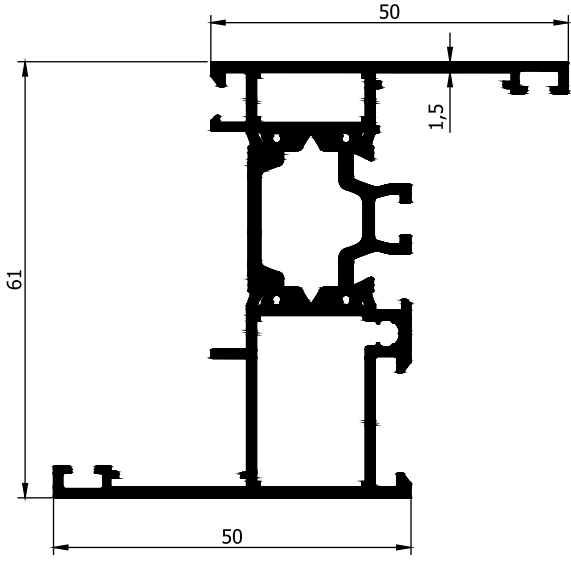

AD31-005
1,293 Kg/m

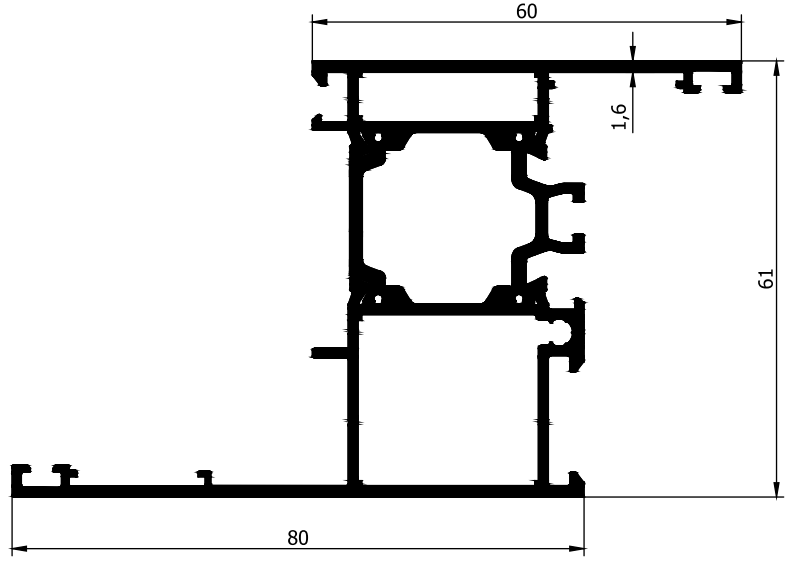

AD31-006
1,573 Kg/m

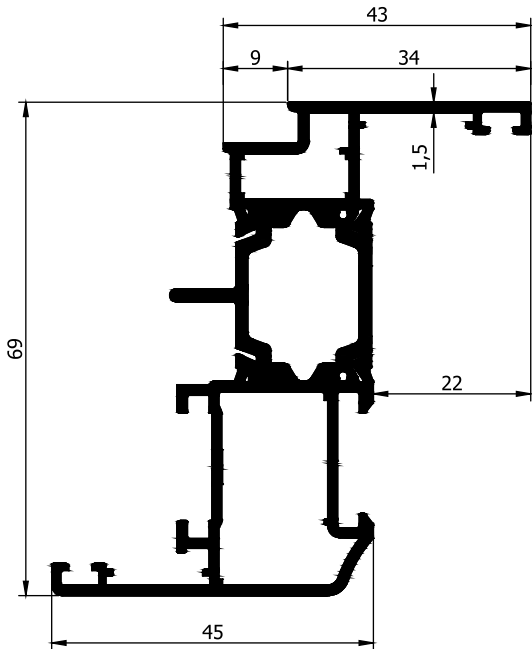

AD31-007
1,309 Kg/m

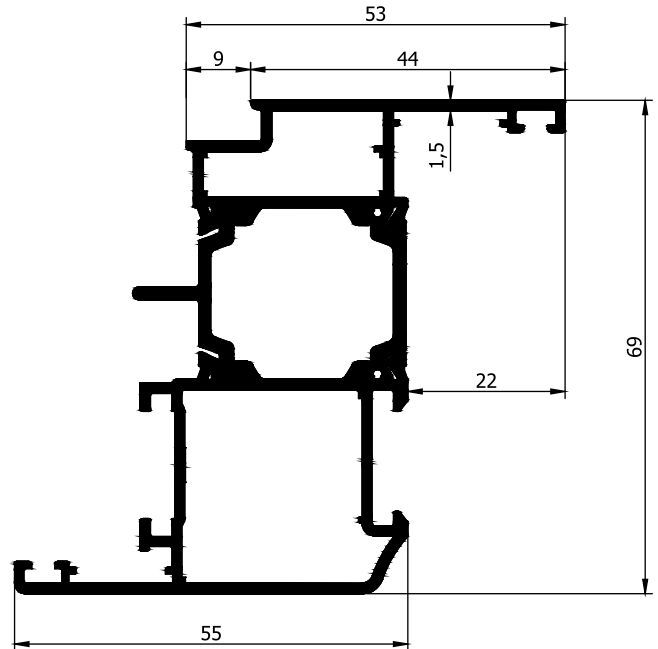

AD31-008
1,471 Kg/m

Uyarı: Profil ağırlıklarımız teorik olup; teslim anındaki tartımız geçerlidir.

AD 61 T YALITIMLI DOĞRAMA SİSTEMİ PROFİLLERİ

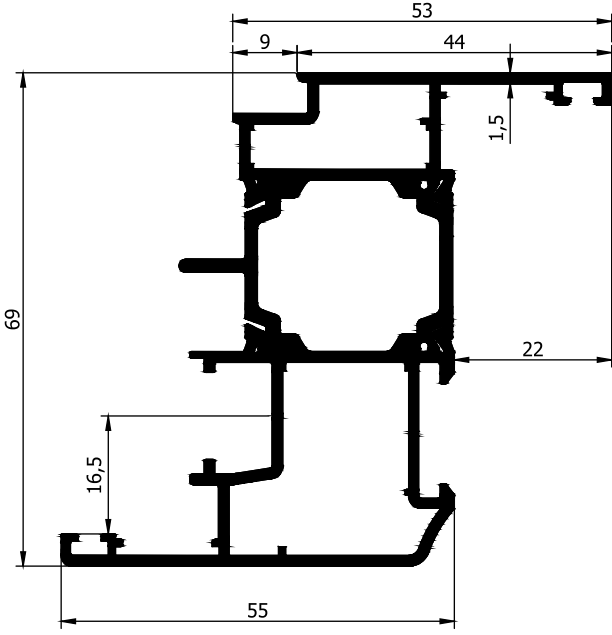

AD31-009
1,491 Kg/m

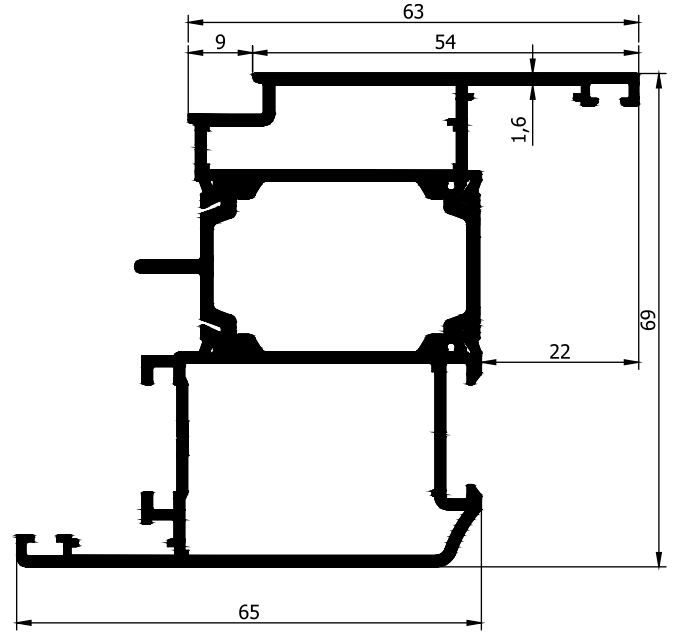

AD31-010
1,682 Kg/m

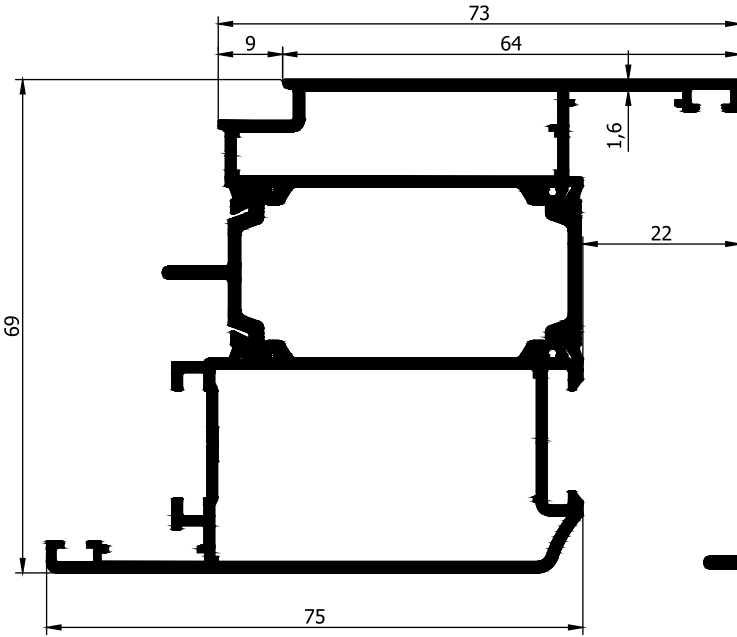

AD31-011
1,850 Kg/m

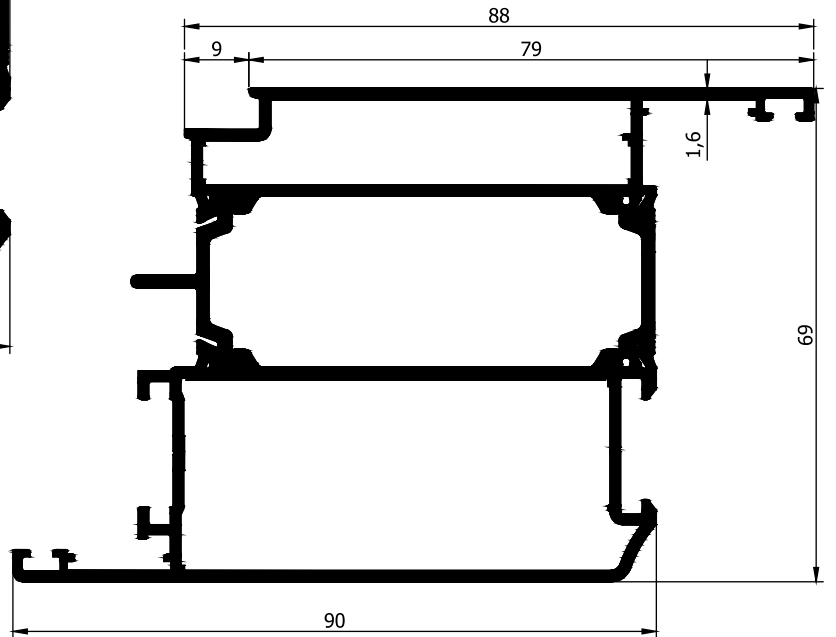

AD31-012
2,101 Kg/m

AD 61 T YALITIMLI DOĞRAMA SİSTEMİ PROFİLLERİ

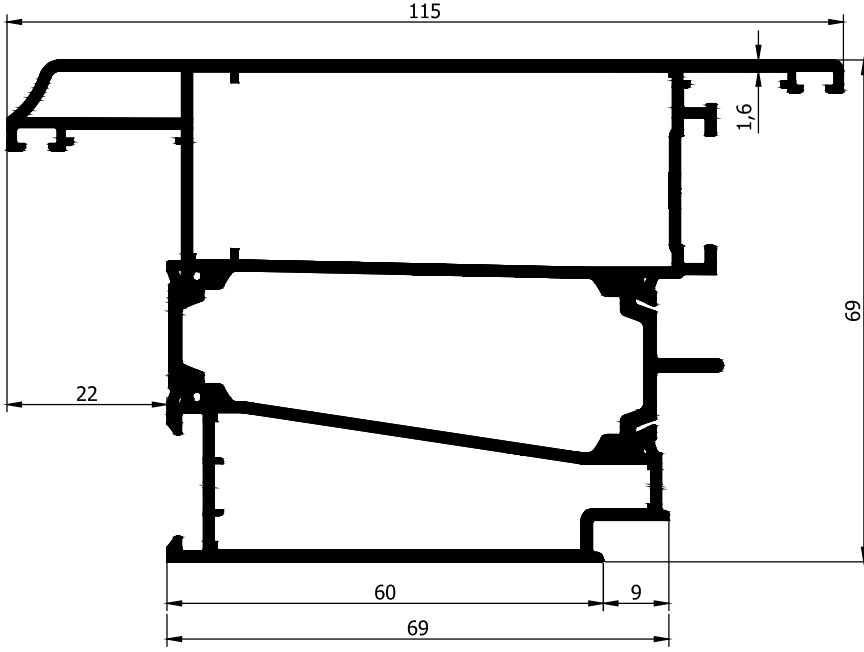

AD31-014
2,267 Kg/m

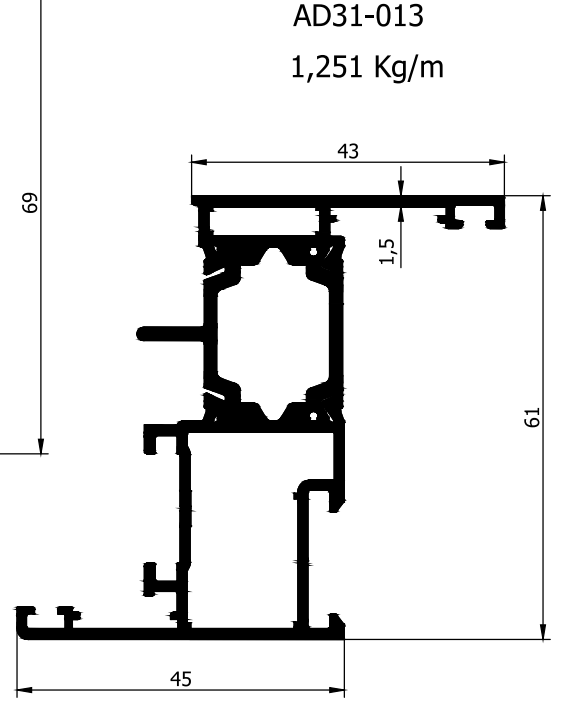

AD31-013
1,251 Kg/m

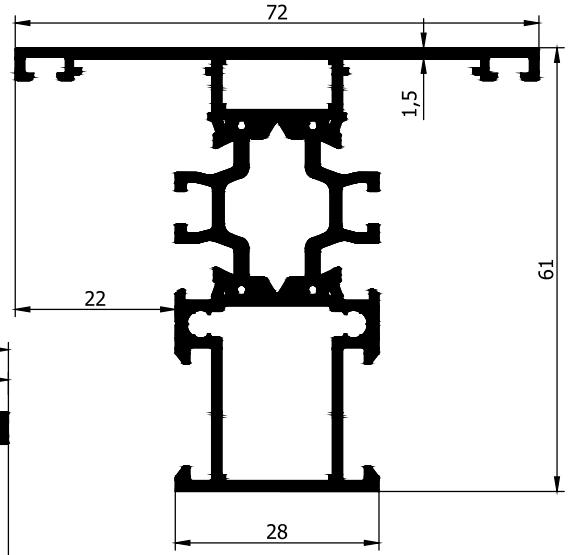

AD31-015
1,345 Kg/m

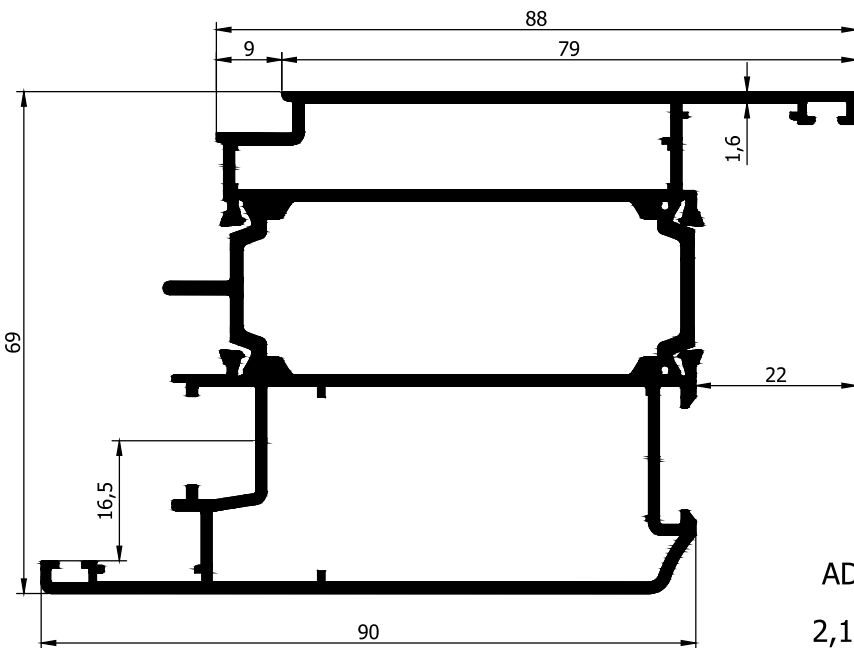

AD31-023
2,116 Kg/m

Uyarı: Profil ağırlıklarımız teorik olup; teslim anındaki tartımız geçerlidir.

AD 61 T YALITIMLI DOĞRAMA SİSTEMİ PROFİLLERİ

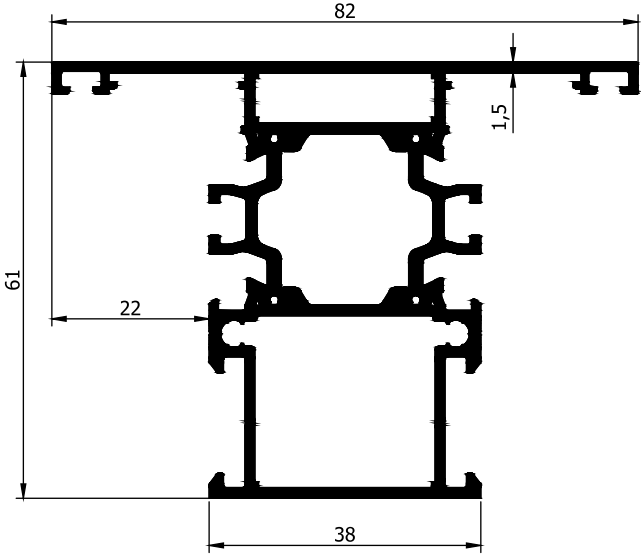

AD31-016
1,537 Kg/m

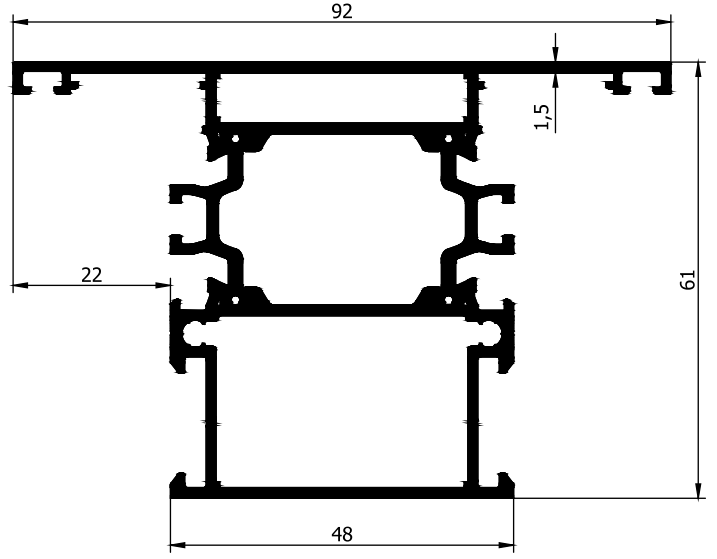

AD31-017
1,671 Kg/m

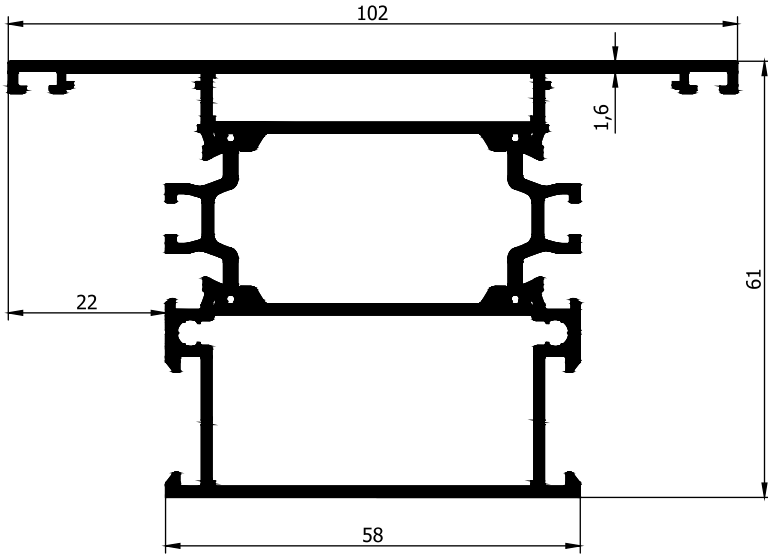

AD31-018
1,885 Kg/m

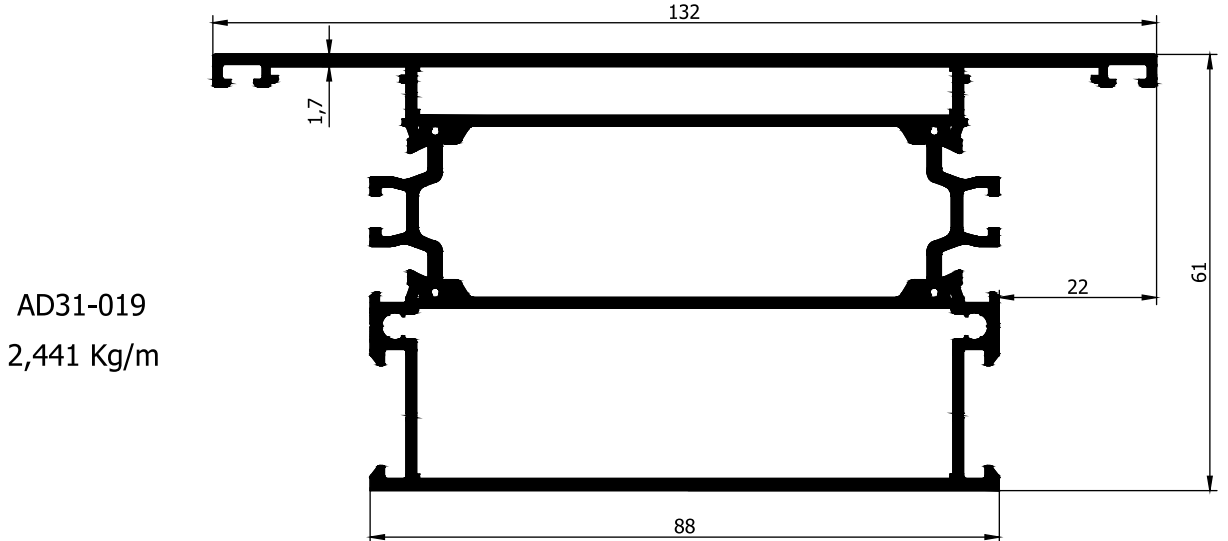

AD31-019
2,441 Kg/m

Uyarı: Profil ağırlıklarımız teorik olup; teslim anındaki tartımız geçerlidir.

AD 61 T YALITIMLI DOĞRAMA SİSTEMİ PROFİLLERİ

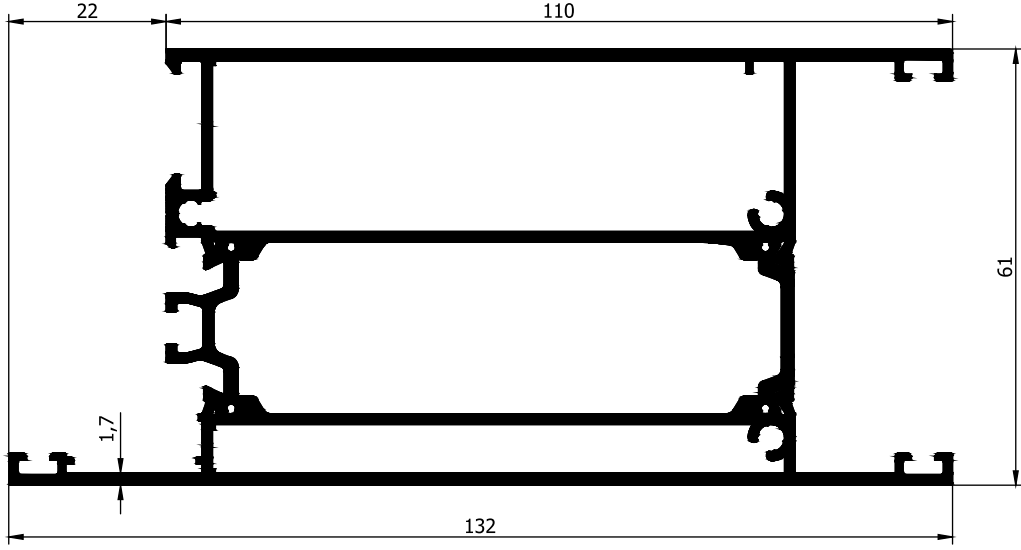

AD31-020

2,562 Kg/m

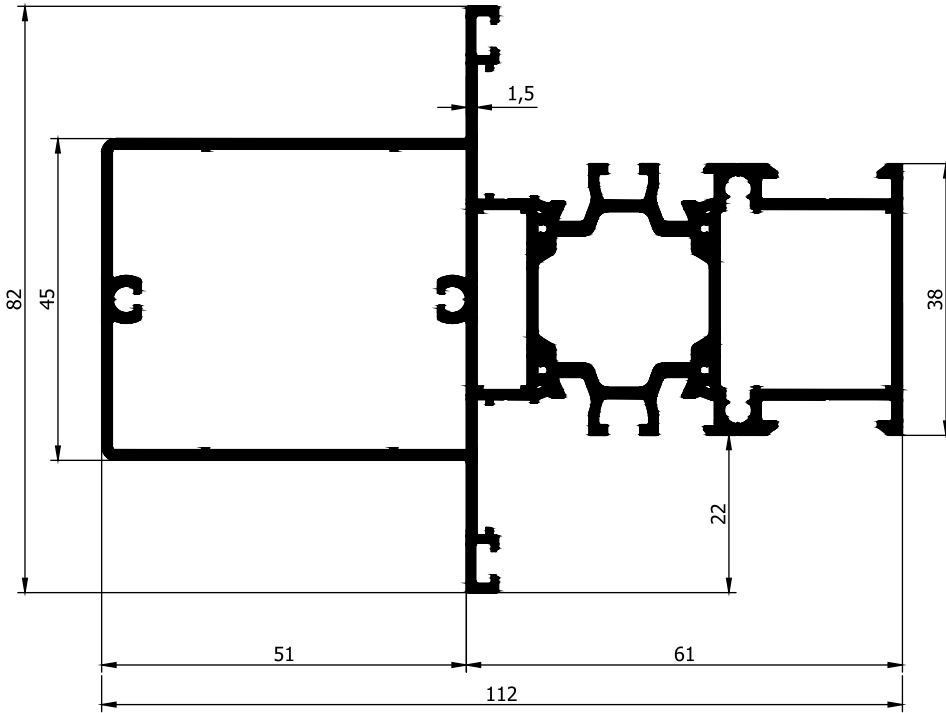

AD31-021

2,173 Kg/m

AD 61 T YALITIMLI DOĞRAMA SİSTEMİ PROFİLLERİ

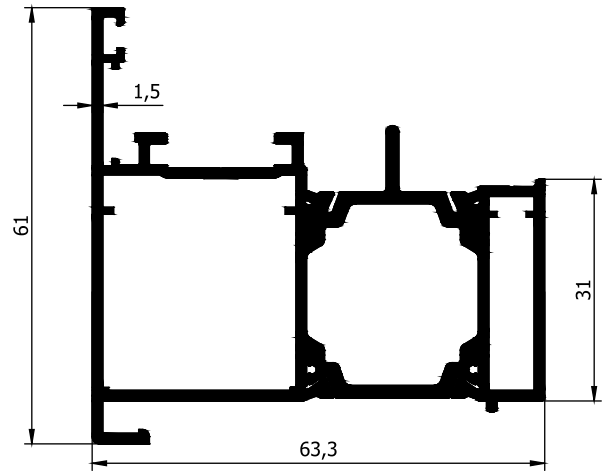
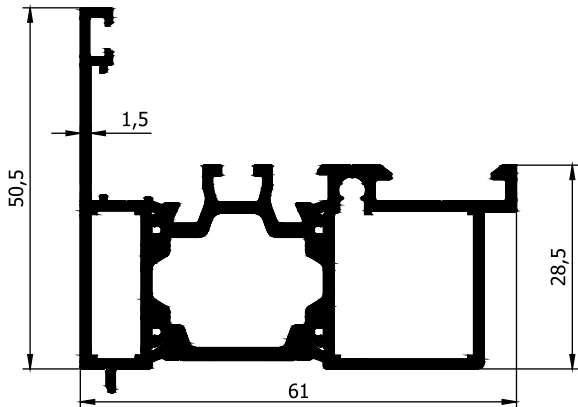
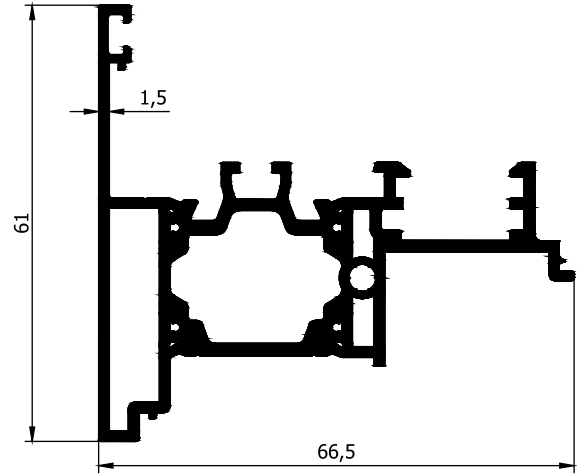
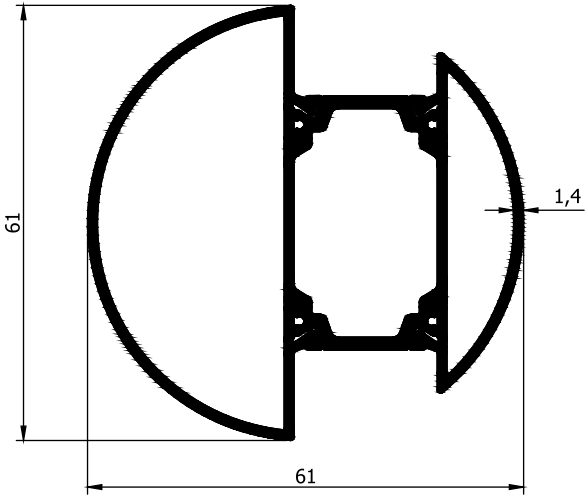
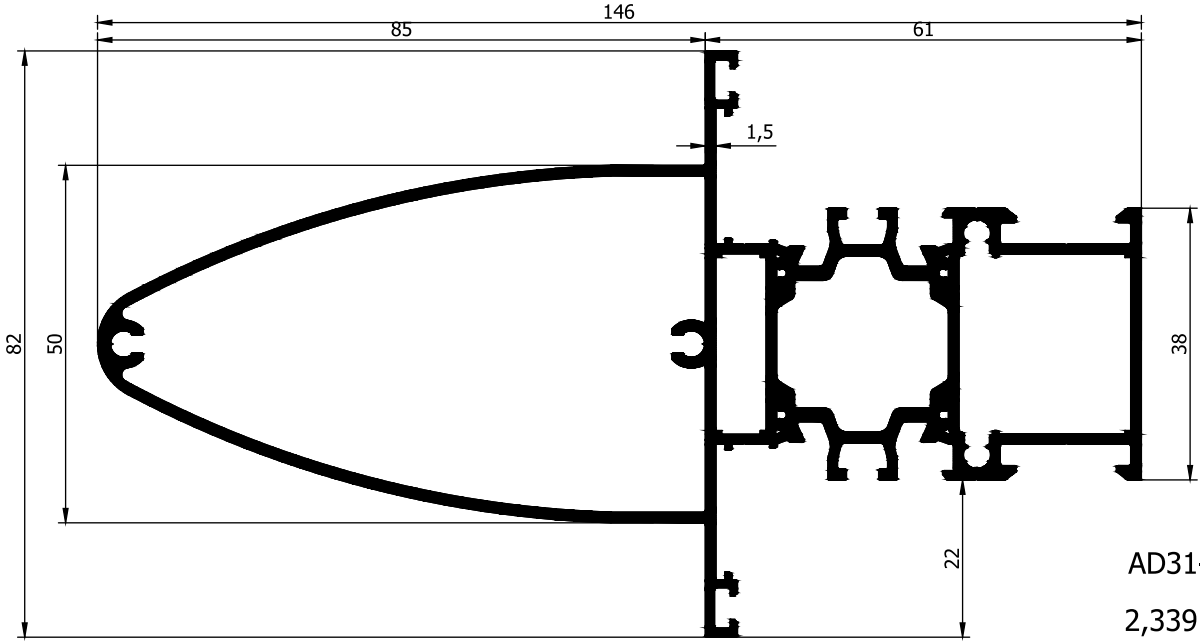

AD 61 T YALITIMLI DOĞRAMA SİSTEMİ PROFİLLERİ 2mm

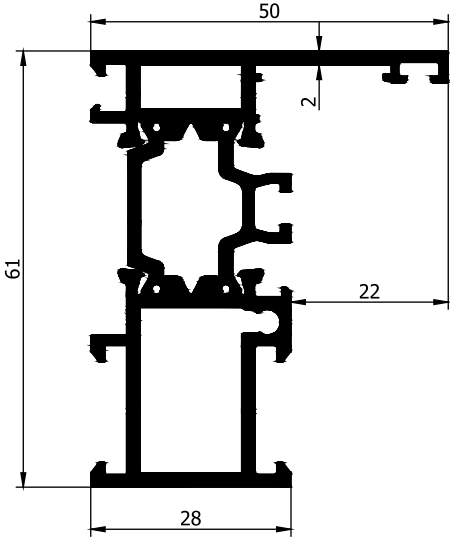

AD31-035
1,387 Kg/m

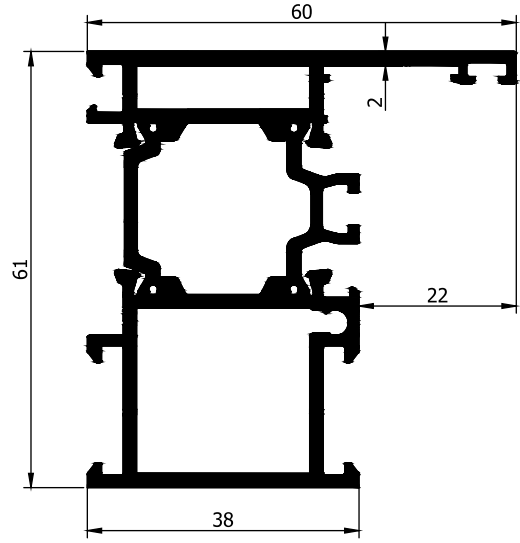

AD31-036
1,602 Kg/m

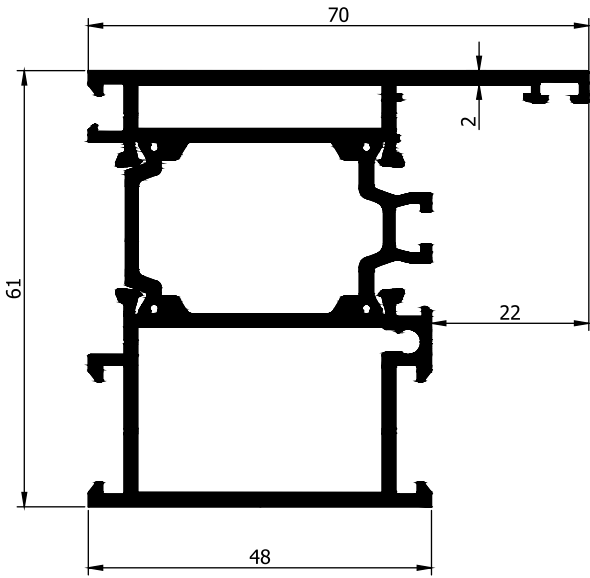

AD31-030
1,813 Kg/m

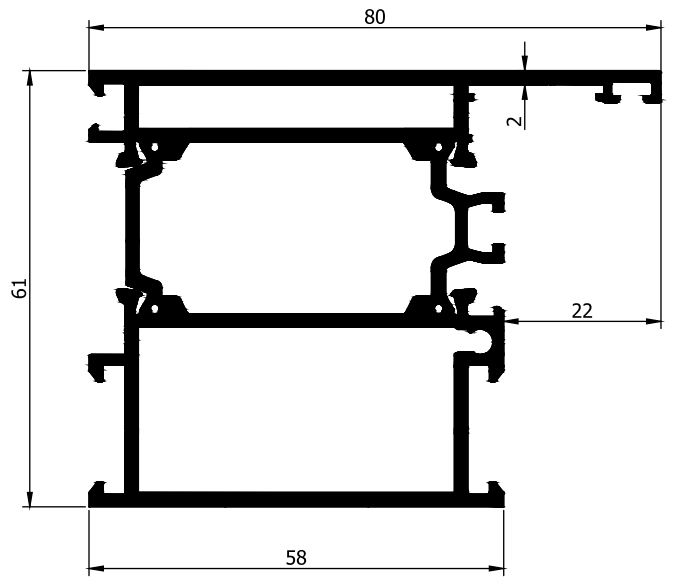

AD31-037
2,024 Kg/m

Uyarı: Profil ağırlıklarımız teorik olup; teslim anındaki tartımız geçerlidir.

AD 61 T YALITIMLI DOĞRAMA SİSTEMİ PROFİLLERİ 2mm

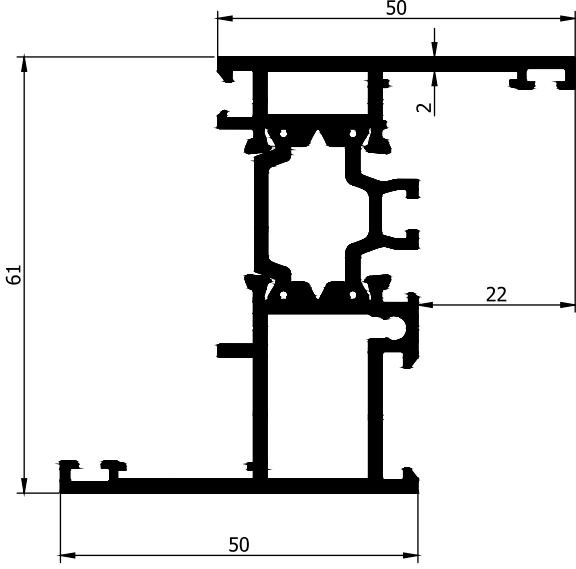

AD31-038
1,517 Kg/m

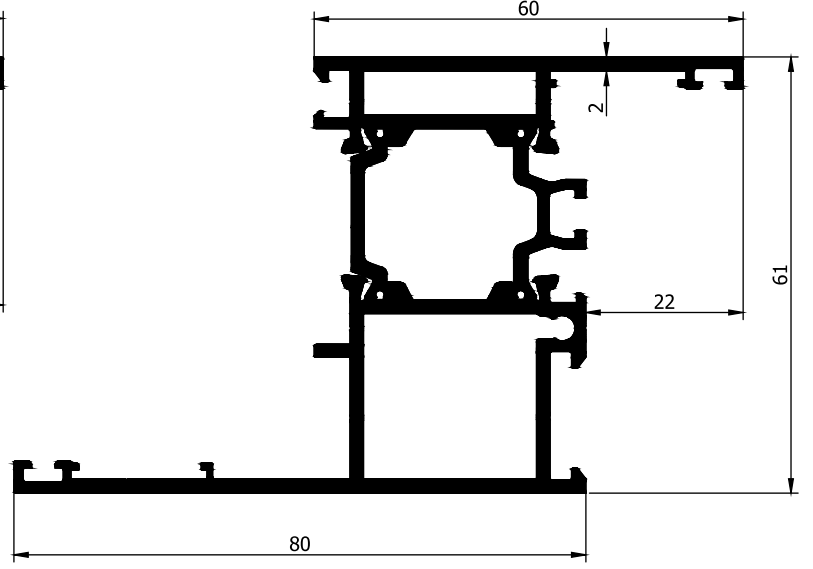

AD31-039
1,845 Kg/m

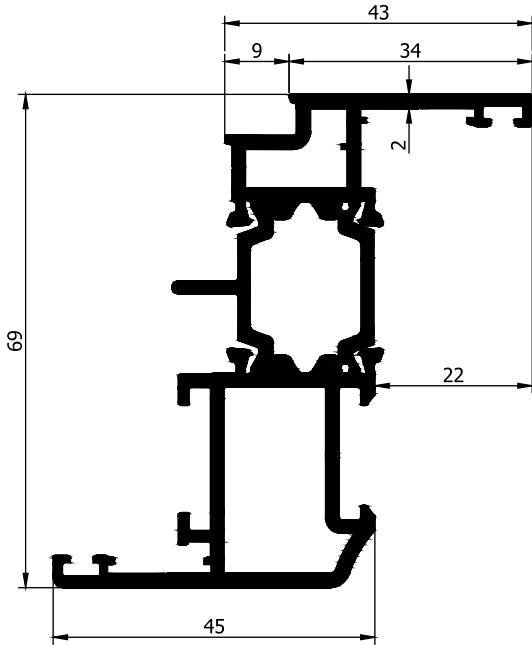

AD31-040
1,537 Kg/m

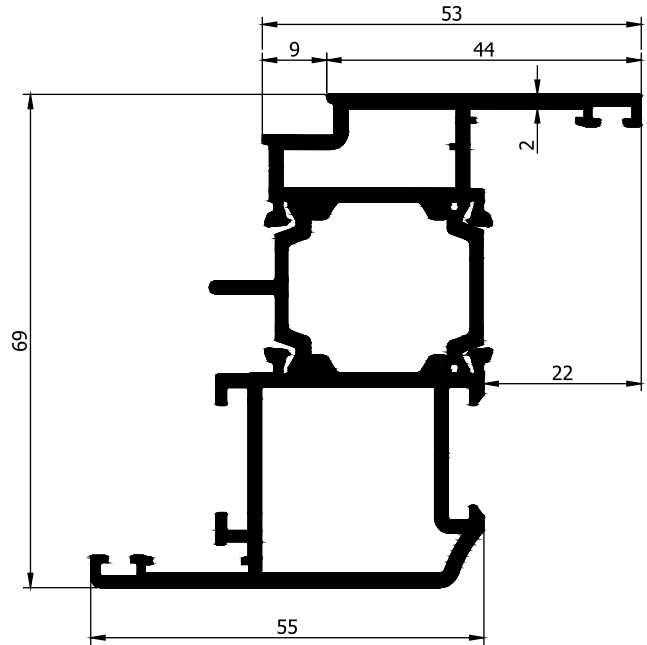

AD31-031
1,746 Kg/m

Uyarı: Profil ağırlıklarımız teorik olup; teslim anındaki tartımız geçerlidir.

AD 61 T YALITIMLI DOĞRAMA SİSTEMİ PROFİLLERİ 2mm

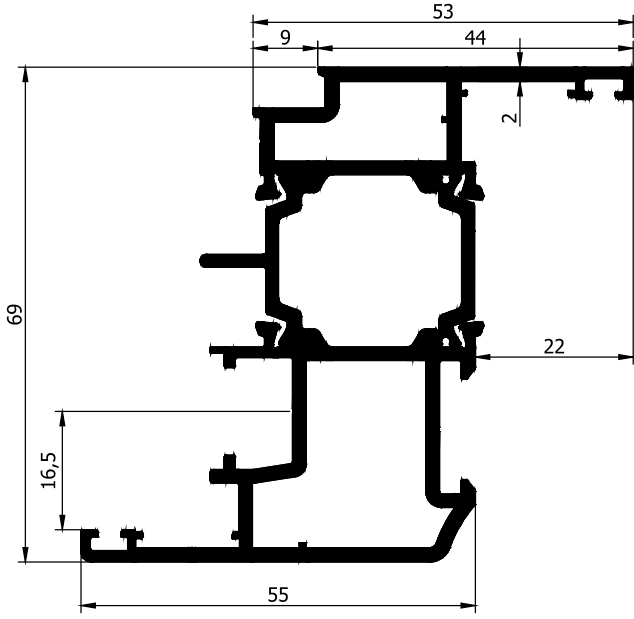

AD31-041
1,757 Kg/m

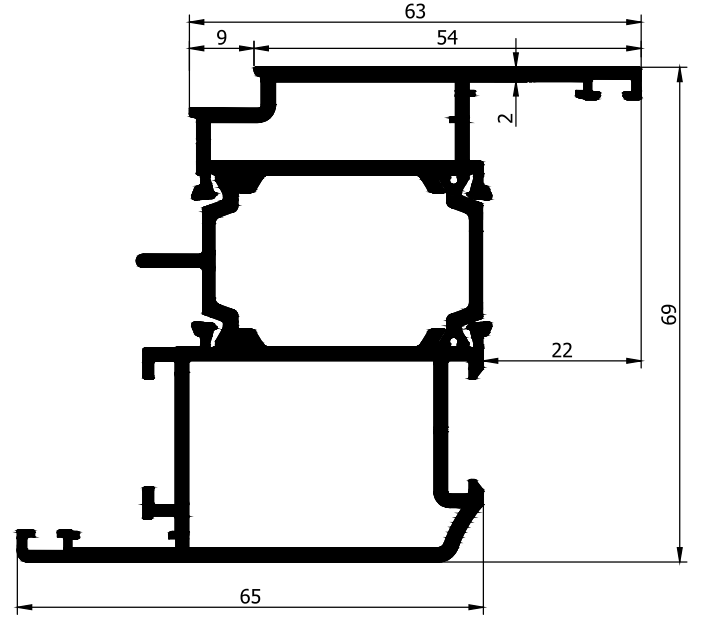

AD31-042
1,957 Kg/m

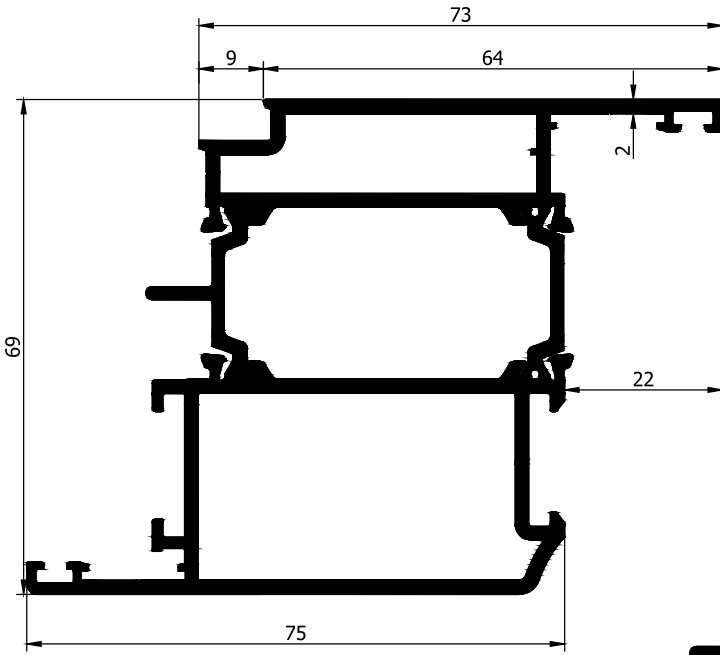

AD31-043
2,168 Kg/m

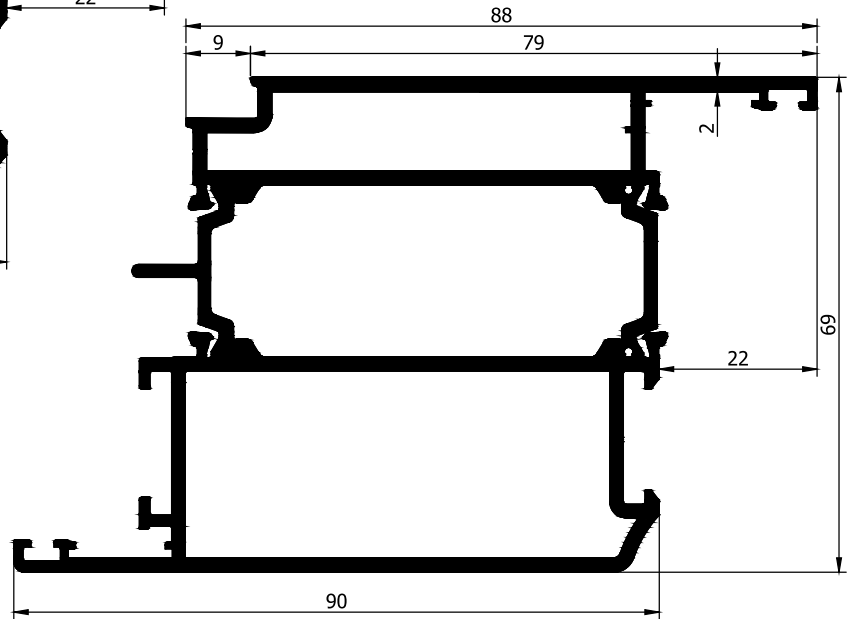

AD31-032
2,485 Kg/m

Uyarı: Profil ağırlıklarımız teorik olup; teslim anındaki tartımız geçerlidir.

AD 61 T YALITIMLI DOĞRAMA SİSTEMİ PROFİLLERİ 2mm

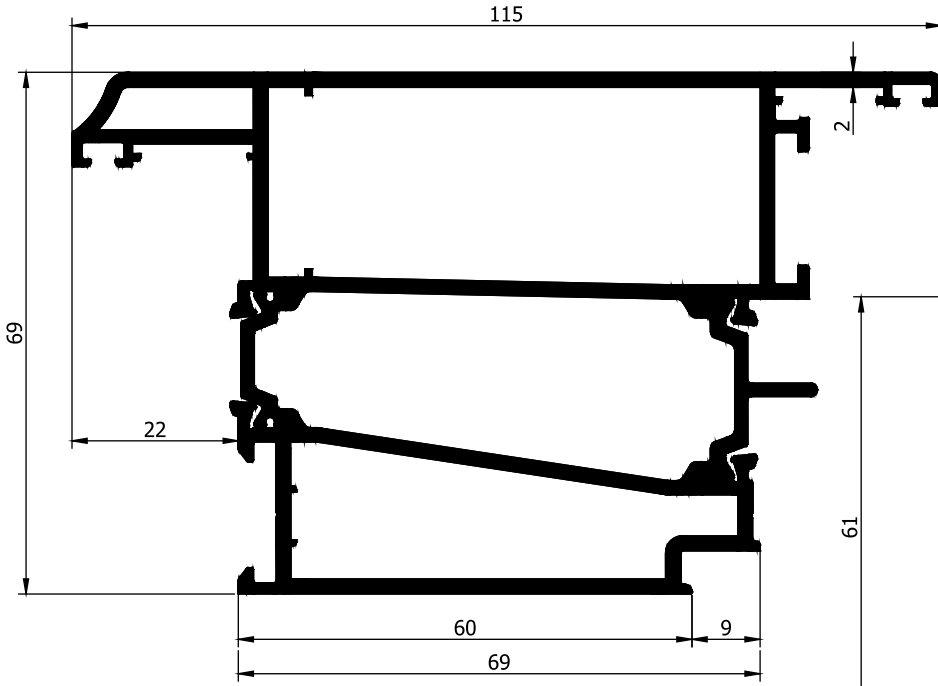

AD31-033
2,708 Kg/m

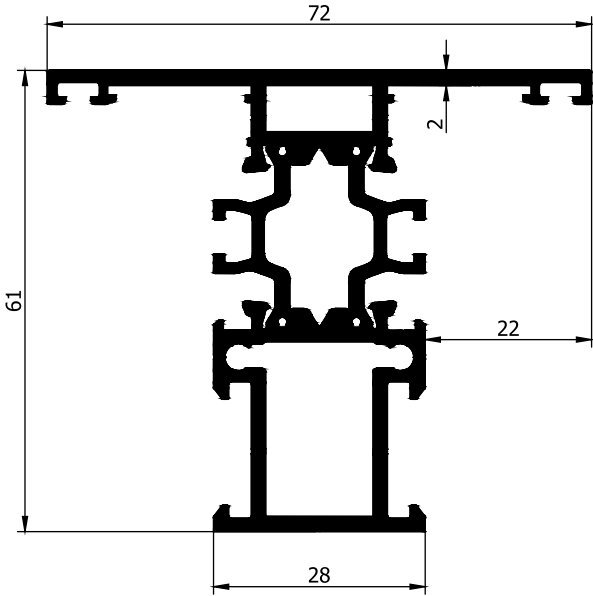
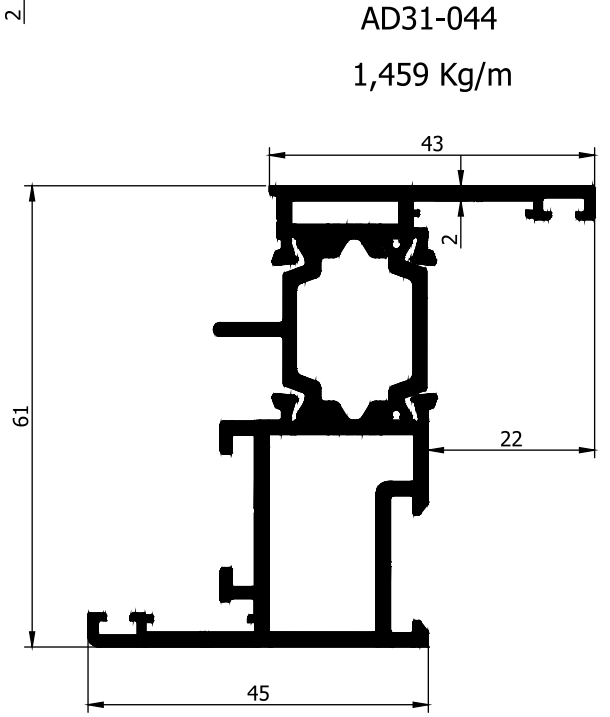

AD31-045
1,562 Kg/m

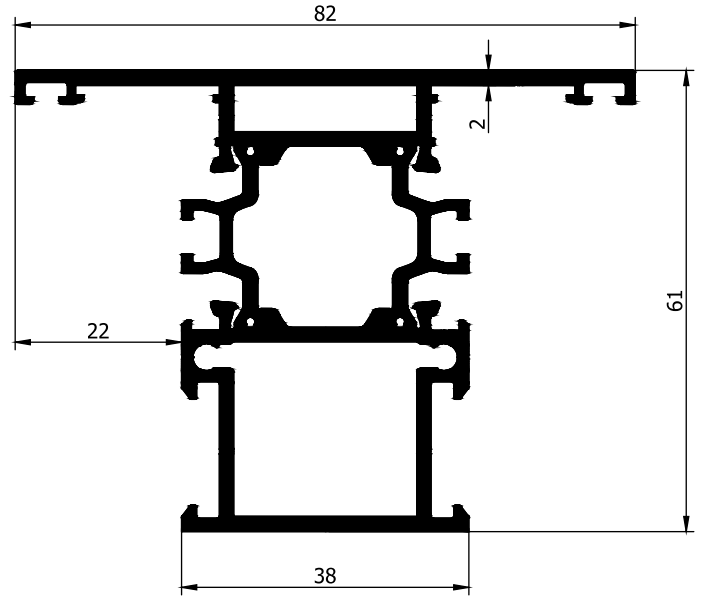

AD31-046
1,774 Kg/m

Uyarı: Profil ağırlıklarımız teorik olup; teslim anındaki tartımız geçerlidir.

AD 61 T YALITIMLI DOĞRAMA SİSTEMİ PROFİLLERİ 2mm

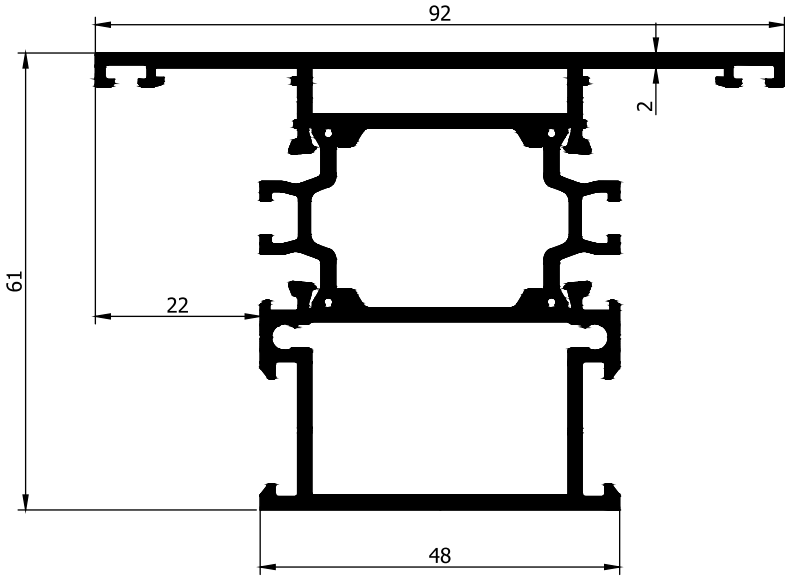

AD31-034
1,985 Kg/m

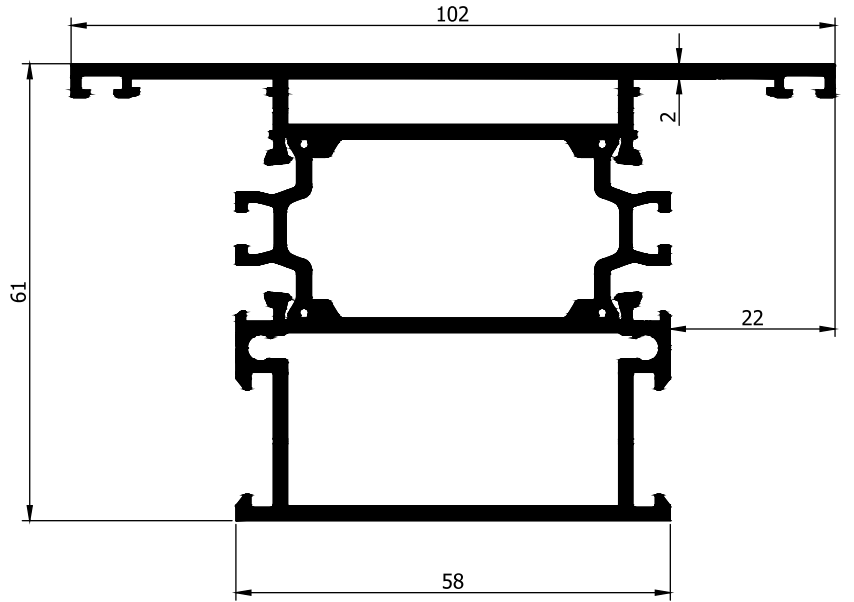

AD31-047
2,196 Kg/m

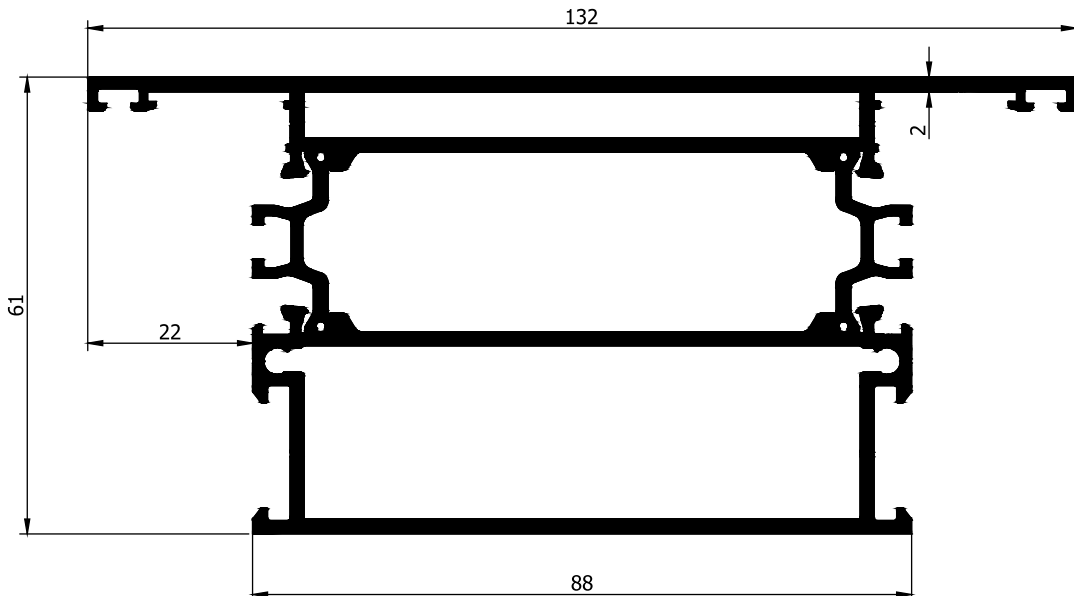

AD31-048
2,831 Kg/m

Uyarı: Profil ağırlıklarımız teorik olup; teslim anındaki tartımız geçerlidir.

AD 61 T YALITIMLI DOĞRAMA SİSTEMİ PROFİLLERİ 2mm

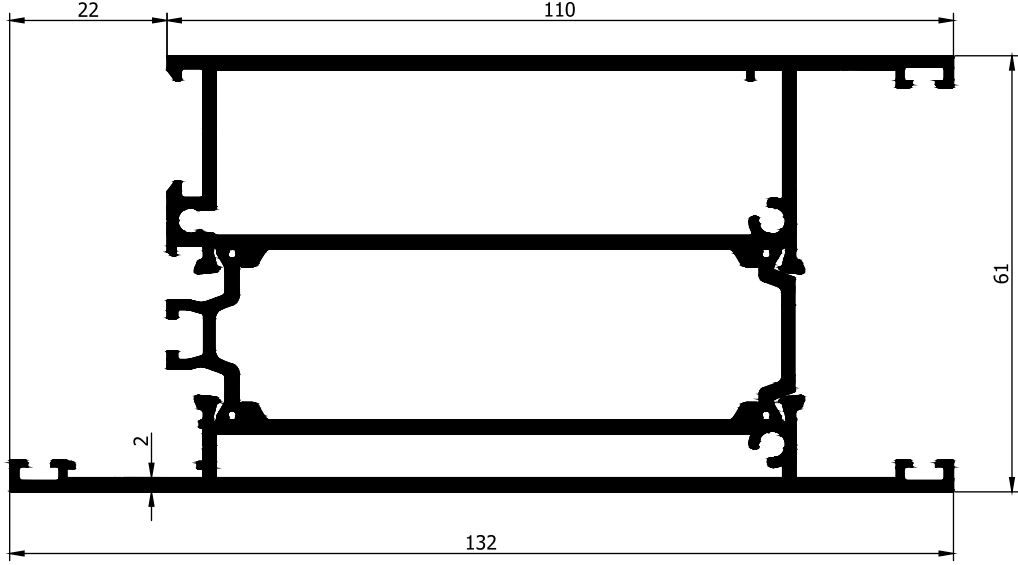

AD31-049
2,954 Kg/m

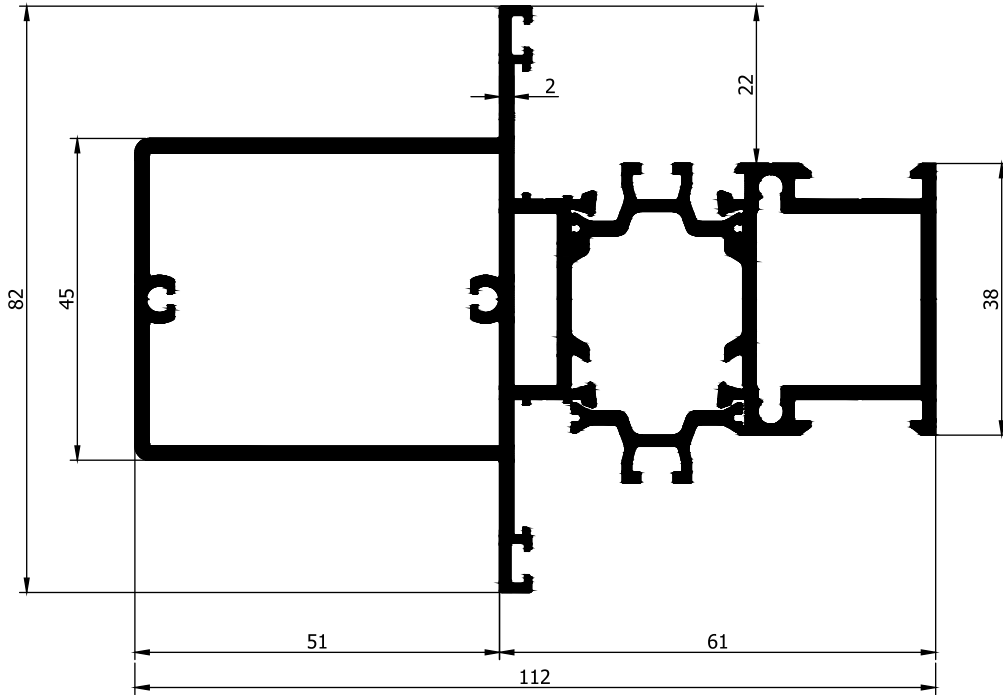

AD31-050
2,617 Kg/m

Uyarı: Profil ağırlıklarımız teorik olup; teslim anındaki tartımız geçerlidir.

AD 61 T YALITIMLI DOĞRAMA SİSTEMİ PROFİLLERİ 2mm

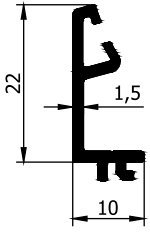
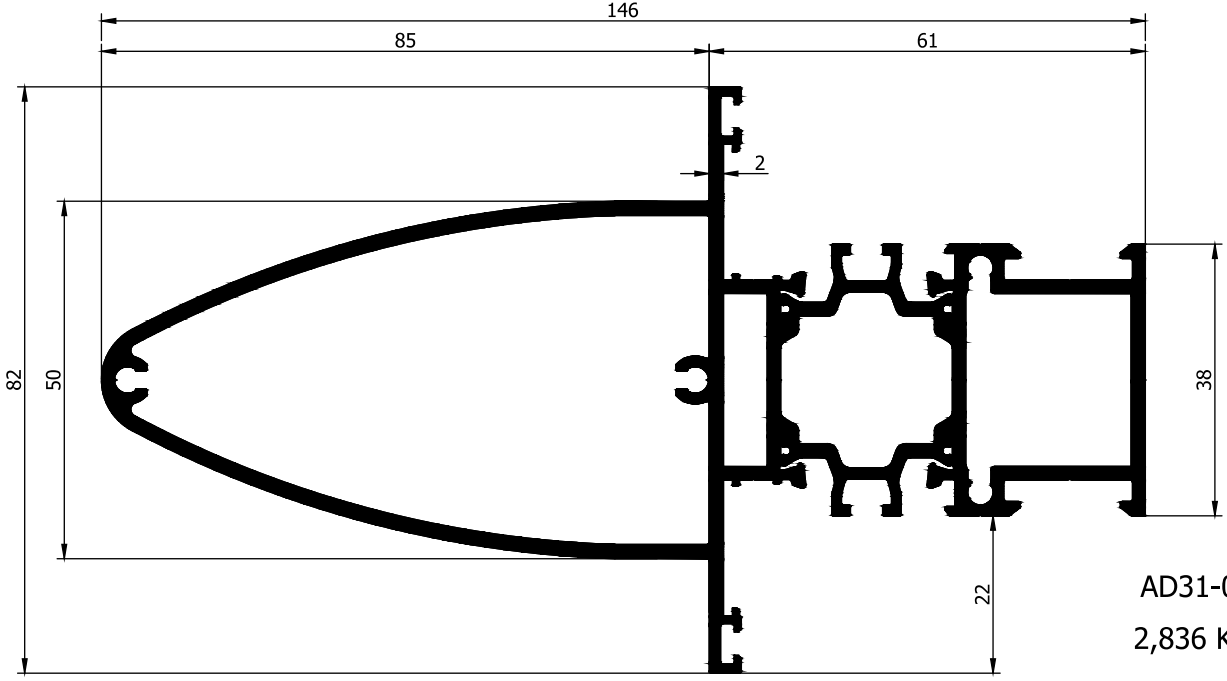

AD 21 - 040

0,179 Kg/m

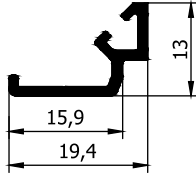

AD 21 - 041

0,140 Kg/m

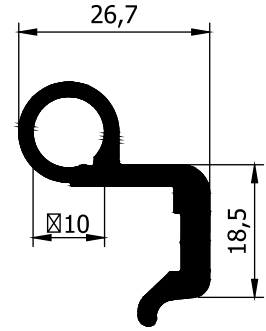

KASA MENTEŞE

AD 21 - 080

0,575 Kg/m

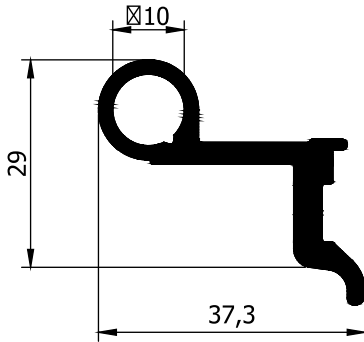

KANAT MENTEŞE

AD 21 - 081

0,640 Kg/m

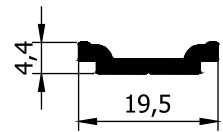

AD20-038

0,130 Kg/m

Uyarı: Profil ağırlıklarımız teorik olup; teslim anındaki tartımız geçerlidir.

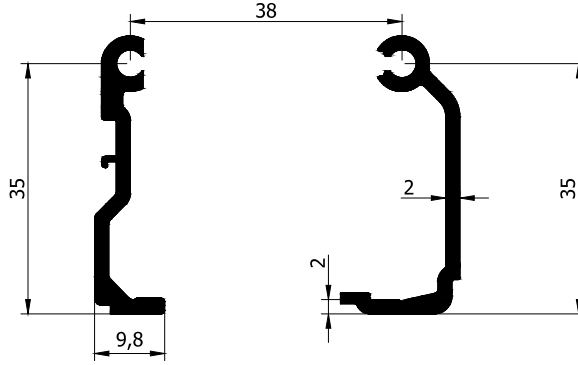
AD 61 T YALITIMLI DOĞRAMA SİSTEMİ PROFİLLERİ**ORTA KAYIT
BAĞLANTI PROFİLİ**

AD 21 - 042

0,327 Kg/m

**ORTA KAYIT
BAĞLANTI PROFİLİ**

AD 21 - 043

0,347 Kg/m

**AD 21 - 042 ve AD 21 - 043
KESİM ÖLÇÜLERİ**

Kullanılan Prf.	Kesim Ölçüsü
AD 31 - 015	13,7 MM
AD 31 - 016	23,7 MM
AD 31 - 017	33,7 MM
AD 31 - 018	43,7 MM
AD 31 - 019	73,7 MM
AD 31 - 020	73,7 MM
AD 31 - 021	23,7 MM
AD 31 - 022	23,7 MM
AD 31 - 045	13,7 MM
AD 31 - 046	23,7 MM
AD 31 - 034	33,7 MM
AD 31 - 047	43,7 MM
AD 31 - 048	73,7 MM
AD 31 - 049	73,7 MM
AD 31 - 050	23,7 MM
AD 31 - 051	23,7 MM

Uyarı: Profil ağırlıklarımız teorik olup; teslim anındaki tartımız geçerlidir.

AD 61 T YALITIMLI DOĞRAMA SİSTEMİ PROFİLLERİ

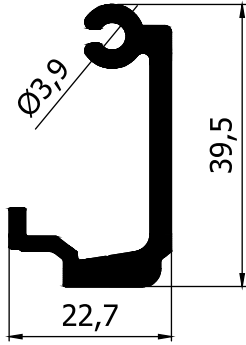

ORTA KAYIT BAĞLANTI PROFİLİ

AD 21 - 074

0,623 Kg/m

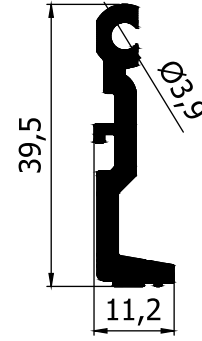

ORTA KAYIT BAĞLANTI PROFİLİ

AD 21 - 075

0,444 Kg/m

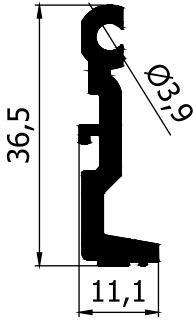

ORTA KAYIT BAĞLANTI PROFİLİ

AD 21 - 076

0,420 Kg/m

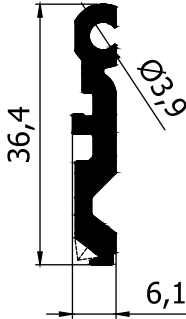

ORTA KAYIT BAĞLANTI PROFİLİ (SETSKURLU)

AD 21 - 077

0,388 Kg/m

AD21-074, AD21-075, AD21-076, AD21-077
PROFİLLERİNİN KESİM ÖLÇÜLERİ

Kullanılan Prf.	Kesim Ölçüsü
AD 31 - 015	13,7 MM
AD 31 - 016	23,7 MM
AD 31 - 017	33,7 MM
AD 31 - 018	43,7 MM
AD 31 - 019	73,7 MM
AD 31 - 020	73,7 MM
AD 31 - 021	23,7 MM
AD 31 - 022	23,7 MM
AD 31 - 045	13,7 MM
AD 31 - 046	23,7 MM
AD 31 - 034	33,7 MM
AD 31 - 047	43,7 MM
AD 31 - 048	73,7 MM
AD 31 - 049	73,7 MM
AD 31 - 050	23,7 MM
AD 31 - 051	23,7 MM

AD 61 T YALITIMLI DOĞRAMA SİSTEMİ PROFİLLERİ

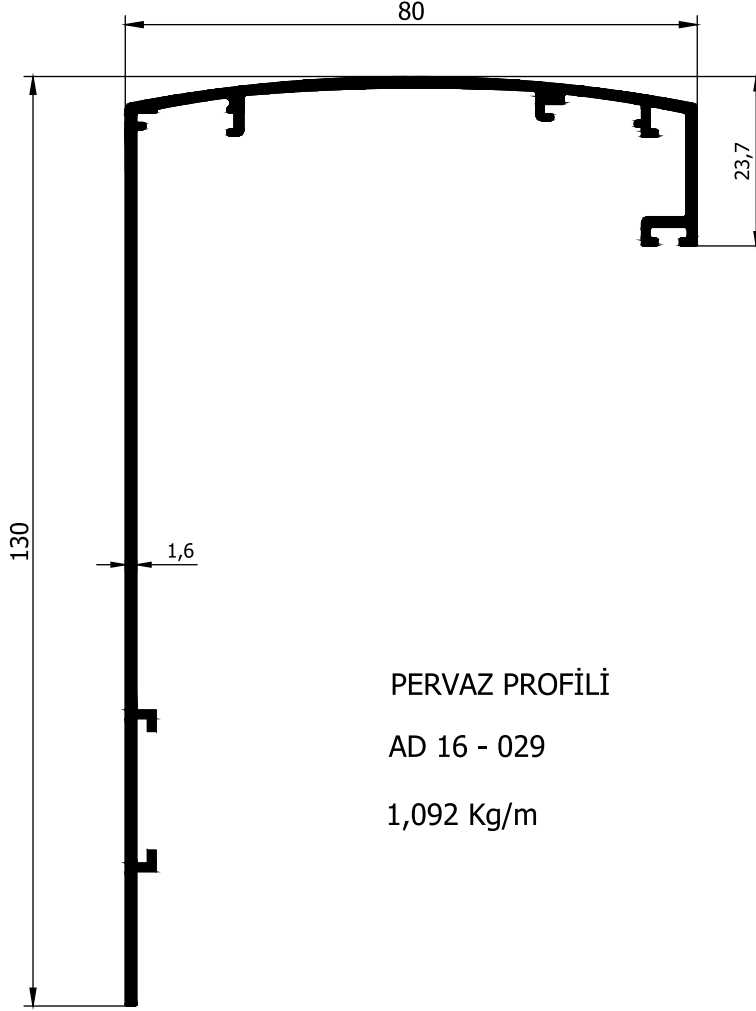

PERVAZ PROFİLİ

AD 16 - 029

1,092 Kg/m

Uyarı: Profil ağırlıklarımız teorik olup; teslim anındaki tartımız geçerlidir.

AD 61 T YALITIMLI DOĞRAMA SİSTEMİ PROFİLLERİ

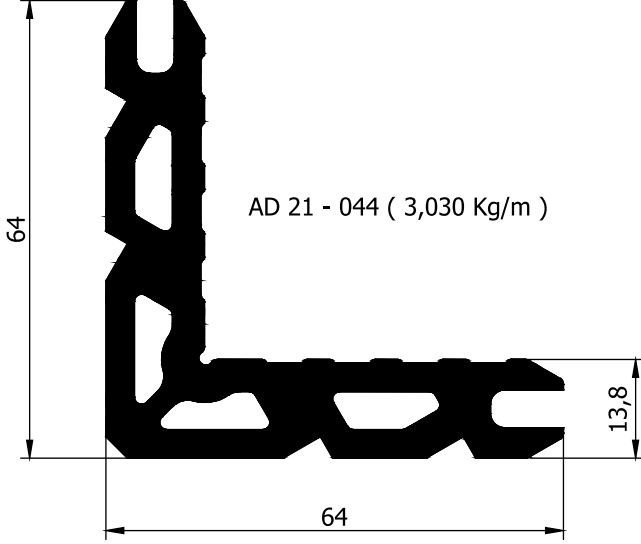

AD 21 - 044 (3,030 Kg/m)

Kullanılan Prf.	Dış Bölüm Kesim Ölçüsü	İç Bölüm Kesim Ölçüsü
AD 31 - 001 AD 31 - 005 AD 31 - 015	6,5 mm	23,5 mm
AD 31 - 007	5,9 mm	26,5 mm
AD 31 - 013	3,5 mm	26,5 mm
AD 31 - 035 AD 31 - 038 AD 31 - 045	5,7 mm	22,7 mm
AD 31 - 040	5 mm	25,7 mm
AD 31 - 044	2,7 mm	25,7 mm

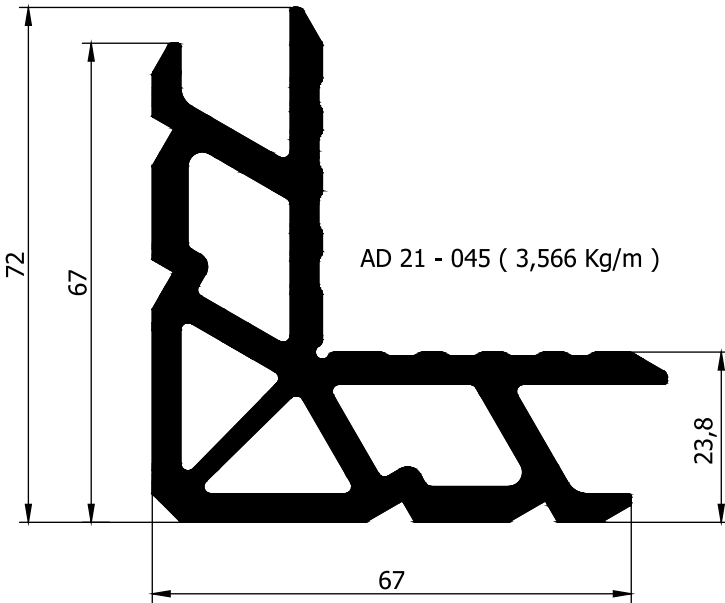

AD 21 - 045 (3,566 Kg/m)

Kullanılan Prf.	Dış Bölüm Kesim Ölçüsü	İç Bölüm Kesim Ölçüsü
AD 31 - 002 AD 31 - 006 AD 31 - 016 AD 31 - 021 AD 31 - 022	6,5 mm	23,5 mm
AD 31 - 008 AD 31 - 009	5,8 mm 5,9 mm	26,5 mm Farklı
AD 31 - 027		26,5 mm
AD 31 - 036 AD 31 - 039 AD 31 - 046 AD 31 - 050 AD 31 - 051	5,7 mm	22,7 mm
AD 31 - 031 AD 31 - 041	5 mm	25,7 mm FARKLI

Uyarı: Profil ağırlıklarımız teorik olup; teslim anındaki tartımız geçerlidir.

AD 61 T YALITIMLI DOĞRAMA SİSTEMİ PROFİLLERİ

AD 21 - 046 (4,157 Kg/m)

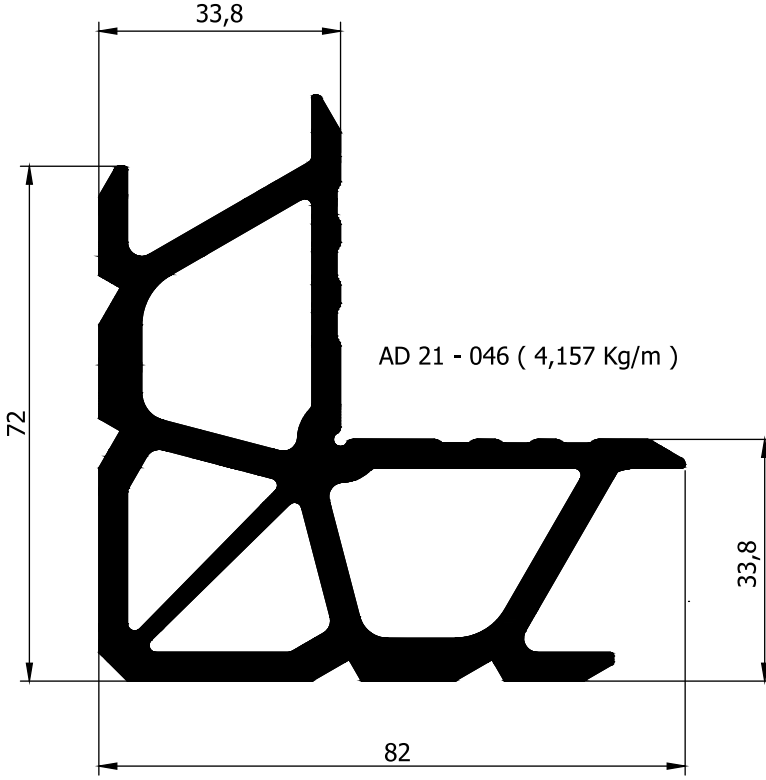

Kullanılan Prf.	Dış Bölüm Kesim Ölçüsü	İç Bölüm Kesim Ölçüsü
AD 31 - 003 AD 31 - 017	6,5 mm	23,5 mm
AD 31 - 010	5,8 mm	26,5 mm
AD 31 - 030 AD 31 - 034	5,7 mm	22,7 mm
AD 31 - 042	5 mm	25,7 mm

AD 21 - 047 (3,220 Kg/m)

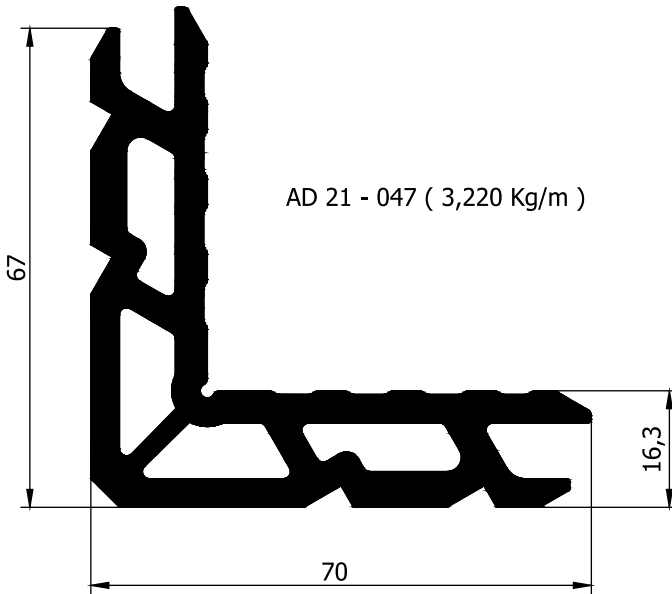

Kullanılan Prf.	Kesim Ölçüsü
AD 31 - 009	26.5 mm
AD 31 - 041	25,7 mm

Uyarı: Profil ağırlıklarımız teorik olup; teslim anındaki tartımız geçerlidir.

AD 61 T YALITIMLI DOĞRAMA SİSTEMİ PROFİLLERİ

AD 21 - 048 (5,307 Kg/m)

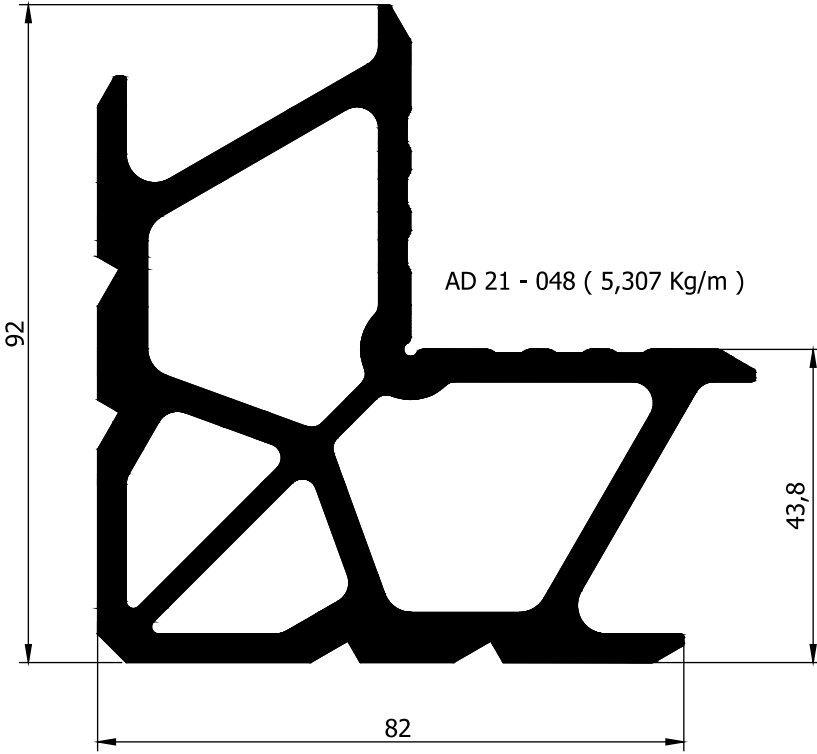

Kullanılan Prf.	Dış Bölüm Kesim Ölçüsü	İç Bölüm Kesim Ölçüsü
AD 31 - 004 AD 31 - 018	6,5 mm	23,5 mm
AD 31 - 011	5,8 mm	26,5 mm
AD 31 - 037 AD 31 - 047	5,7 mm	22,7 mm
AD 31 - 043	5 mm	25,7 mm
AD 31 - 023	FARKLI	26,5 mm

AD 21 - 050 (6,366 Kg/m)

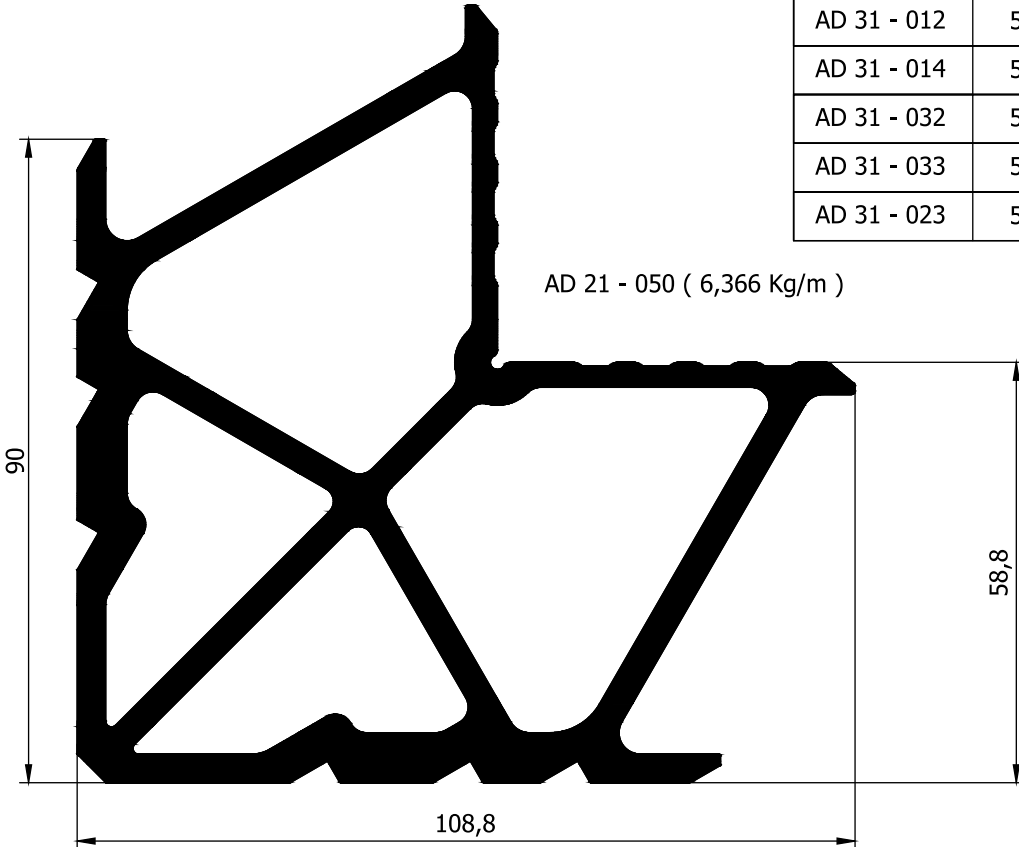

Kullanılan Prf.	Dış Bölüm Kesim Ölçüsü	İç Bölüm Kesim Ölçüsü
AD 31 - 012	5,8 mm	26,5 mm
AD 31 - 014	5,8 mm	25,5 mm
AD 31 - 032	5 mm	25,7 mm
AD 31 - 033	5 mm	24,7 mm
AD 31 - 023	5,8 mm	FARKLI

Uyarı: Profil ağırlıklarımız teorik olup; teslim anındaki tartımız geçerlidir.

AD 61 T YALITIMLI DOĞRAMA SİSTEMİ PROFİLLERİ

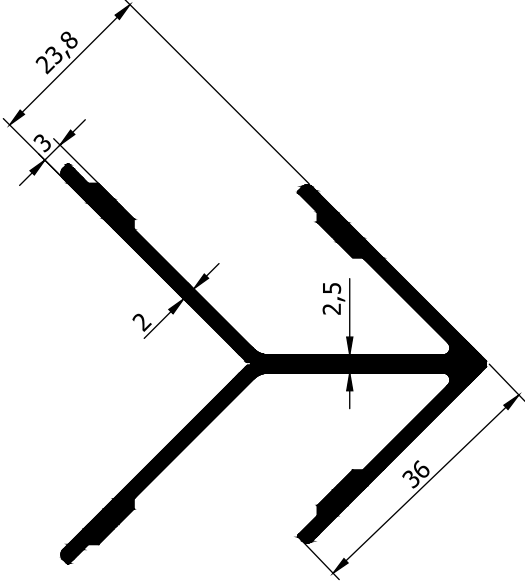

AD 20 - 048 (1,079 Kg/m)

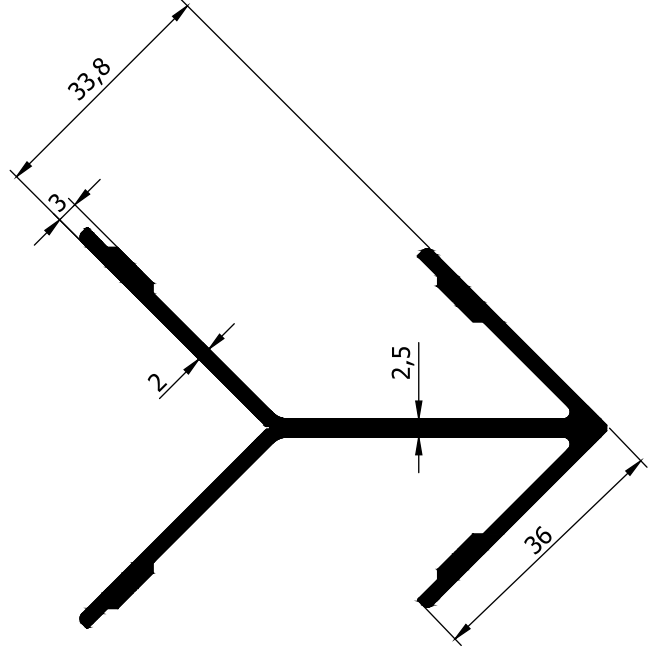

AD 20 - 049 (1,176 Kg/m)

Kullanılan Prf.	Dış Bölüm Kesim Ölçüsü	İç Bölüm Kesim Ölçüsü
AD 31 - 002 AD 31 - 006 AD 31 - 016 AD 31 - 021 AD 31 - 022	6,5 mm	23,5 mm
AD 31 - 008 AD 31 - 009	5,8 mm 5,9 mm	26,5 mm Farklı
AD 31 - 027		26,5 mm
AD 31 - 036 AD 31 - 039 AD 31 - 046 AD 31 - 050 AD 31 - 051	5,7 mm	22,7 mm
AD 31 - 031 AD 31 - 041	5 mm	25,7 mm FARKLI

Kullanılan Prf.	Dış Bölüm Kesim Ölçüsü	İç Bölüm Kesim Ölçüsü
AD 31 - 003 AD 31 - 017	6,5 mm	23,5 mm
AD 31 - 010	5,8 mm	26,5 mm
AD 31 - 030 AD 31 - 034	5,7 mm	22,7 mm
AD 31 - 042	5 mm	25,7 mm

Uyarı: Profil ağırlıklarımız teorik olup; teslim anındaki tartımız geçerlidir.

AD 61 T YALITIMLI DOĞRAMA SİSTEMİ PROFİLLERİ

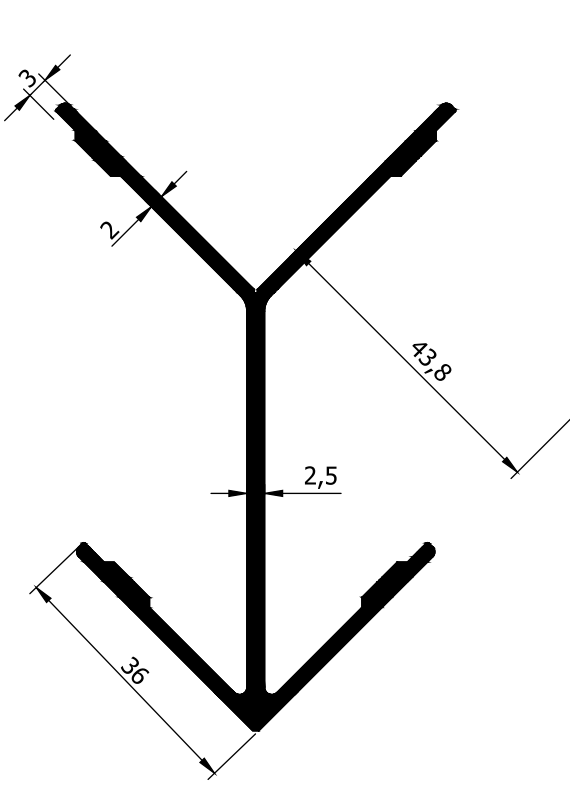

AD 20 - 050 (1,271 Kg/m)

Kullanılan Prf.	Dış Bölüm Kesim Ölçüsü	İç Bölüm Kesim Ölçüsü
AD 31 - 004 AD 31 - 018	6,5 mm	23,5 mm
AD 31 - 011	5,8 mm	26,5 mm
AD 31 - 037 AD 31 - 047	5,7 mm	22,7 mm
AD 31 - 043	5 mm	25,7 mm
AD 31 - 023	FARKLI	26,5 mm

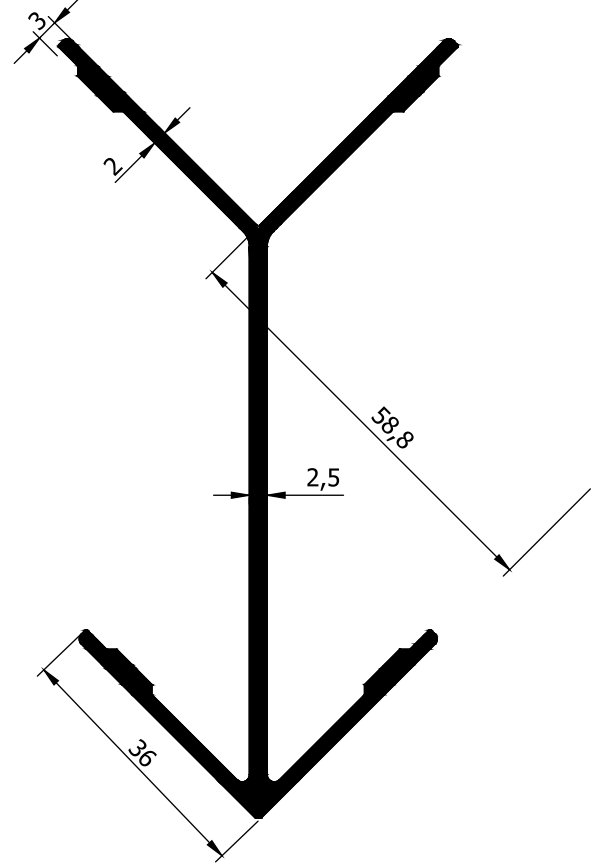

AD 20 - 051 (1,415 Kg/m)

Kullanılan Prf.	Dış Bölüm Kesim Ölçüsü	İç Bölüm Kesim Ölçüsü
AD 31 - 012	5,8 mm	26,5 mm
AD 31 - 014	5,8 mm	25,5 mm
AD 31 - 032	5 mm	25,7 mm
AD 31 - 033	5 mm	24,7 mm
AD 31 - 023	5,8 mm	FARKLI

Uyarı: Profil ağırlıklarımız teorik olup; teslim anındaki tartımız geçerlidir.

AD 61 T YALITIMLI DOĞRAMA SİSTEMİ PROFİLLERİ

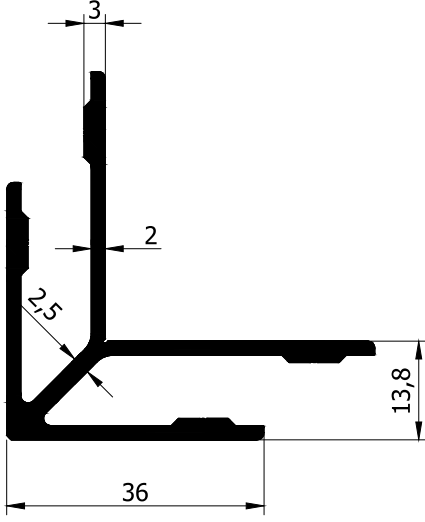

AD 20 - 052 (0,984 Kg/m)

Kullanılan Prf.	Dış Bölüm Kesim Ölçüsü	İç Bölüm Kesim Ölçüsü
AD 31 - 001 AD 31 - 005 AD 31 - 015	6,5 mm	23,5 mm
AD 31 - 007	5,9 mm	26,5 mm
AD 31 - 013	3,5 mm	26,5 mm
AD 31 - 035 AD 31 - 038 AD 31 - 045	5,7 mm	22,7 mm
AD 31 - 040	5 mm	25,7 mm
AD 31 - 044	2,7 mm	25,7 mm

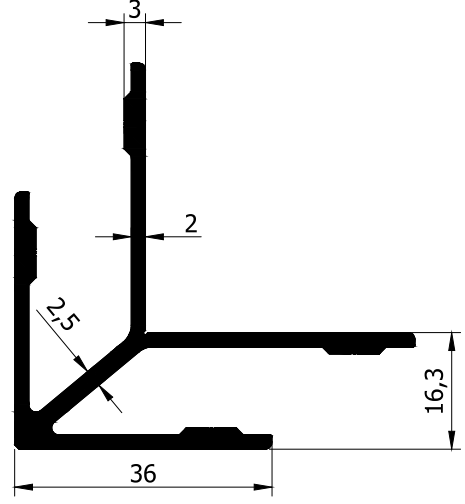

AD 20 - 053 (1,016 Kg/m)

Kullanılan Prf.	Kesim Ölçüsü
AD 31 - 009	26.5 mm
AD 31 - 041	25,7 mm

Uyarı: Profil ağırlıklarımız teorik olup; teslim anındaki tartımız geçerlidir.

AD 61 T YALITIMLI DOĞRAMA SİSTEMİ PROFİLLERİ

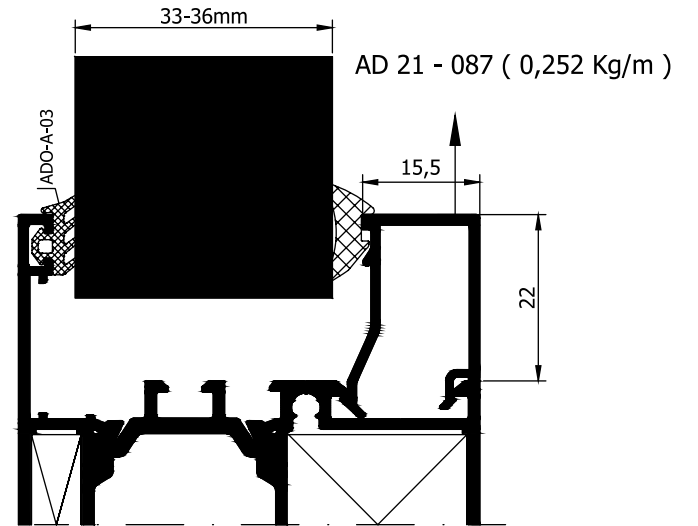
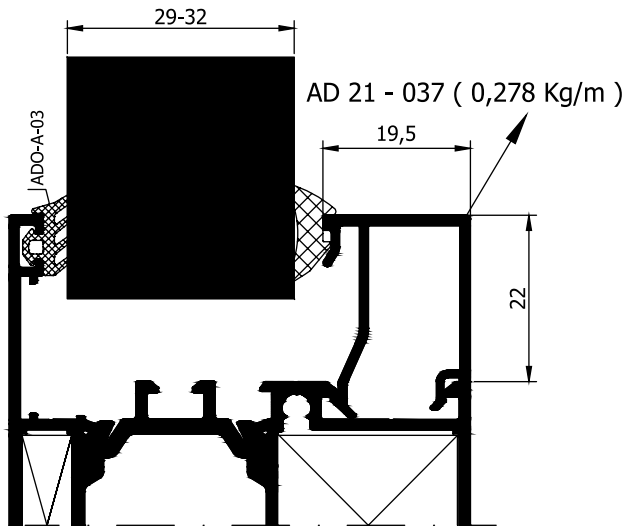
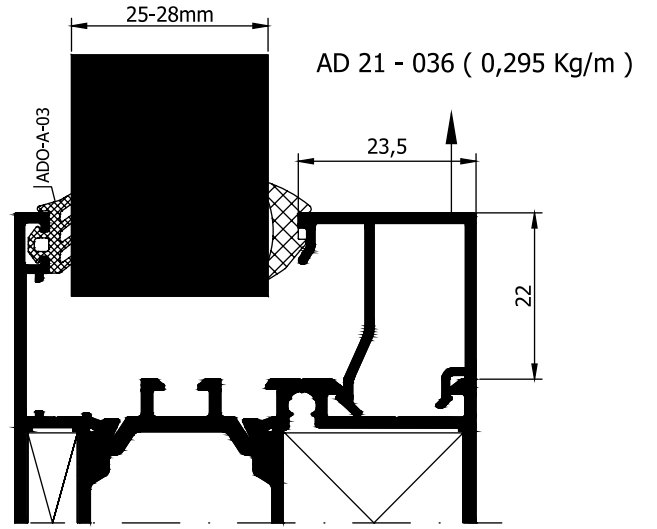
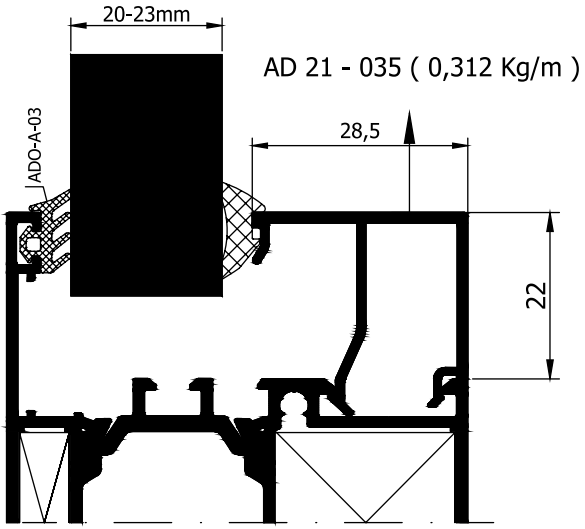
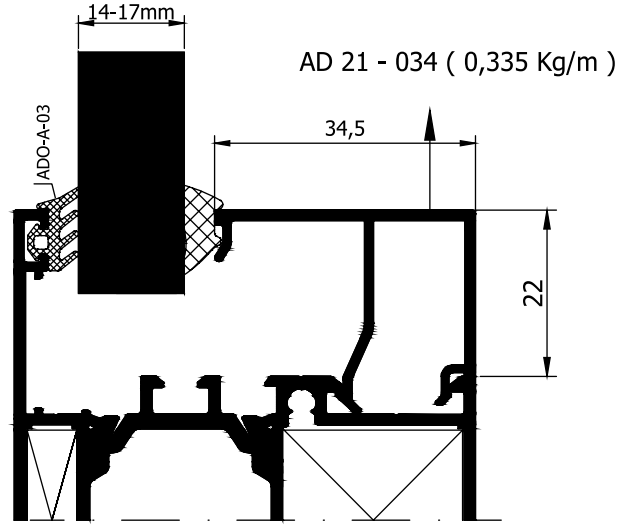
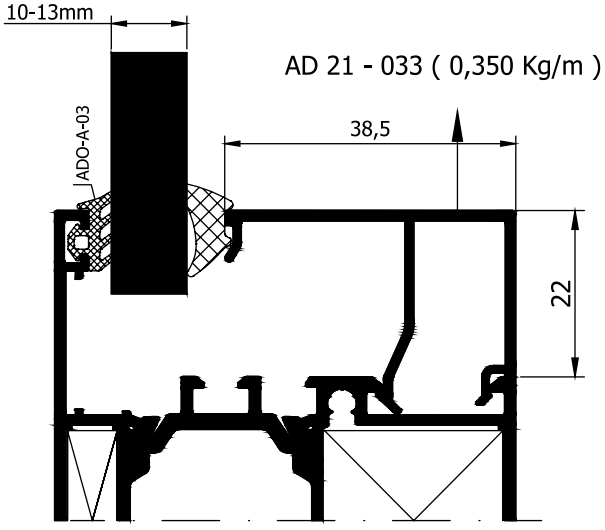

Uyarı: Profil ağırlıklarımız teorik olup; teslim anındaki tartımız geçerlidir.

AD 61 T YALITIMLI DOĞRAMA SİSTEMİ PROFİLLERİ

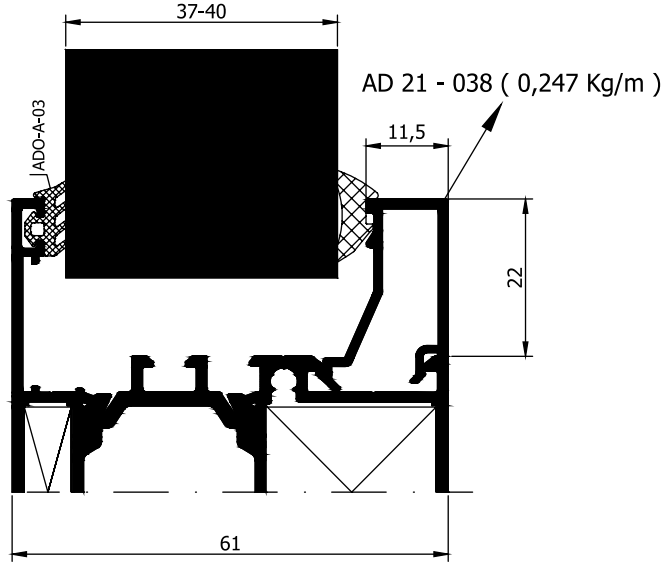

Uyarı: Profil ağırlıklarımız teorik olup; teslim anındaki tartımız geçerlidir.

AD 61 T YALITIMLI DOĞRAMA SİSTEMİ PROFİLLERİ

ÇITA	DIŞ CAM FİTİLİ (3 MM) ADO-A-03	İÇ CAM FİTİLİ		İÇ CAM FİTİLİ KALINLIĞI	CAM-PANEL KALINLIĞI	ÇITA	DIŞ CAM FİTİLİ (3 MM) ADO-A-03	İÇ CAM FİTİLİ		İÇ CAM FİTİLİ KALINLIĞI	CAM-PANEL KALINLIĞI
AD 21 - 033 38.5 mm			ADO-A-05	5 MM	10 MM	AD 21 - 037 19.5 mm			ADO-A-05	5 MM	29 MM
AD 21 - 033 38.5 mm			ADO-A-06	4 MM	11 MM	AD 21 - 037 19.5 mm			ADO-A-06	4 MM	30 MM
AD 21 - 033 38.5 mm			ADO-A-07	3 MM	12 MM	AD 21 - 037 19.5 mm			ADO-A-07	3 MM	31 MM
AD 21 - 033 38.5 mm			ADO-A-08	2 MM	13 MM	AD 21 - 037 19.5 mm			ADO-A-08	2 MM	32 MM
AD 21 - 034 34.5 mm			ADO-A-05	5 MM	14 MM	AD 21 - 087 15.5 mm			ADO-A-05	5 MM	33 MM
AD 21 - 034 34.5 mm			ADO-A-06	4 MM	15 MM	AD 21 - 087 15.5 mm			ADO-A-06	4 MM	34 MM
AD 21 - 034 34.5 mm			ADO-A-07	3 MM	16 MM	AD 21 - 087 15.5 mm			ADO-A-07	3 MM	35 MM
AD 21 - 034 34.5 mm			ADO-A-08	2 MM	17 MM	AD 21 - 087 15.5 mm			ADO-A-08	2 MM	36 MM
AD 21 - 035 28.5 mm			ADO-A-05	5 MM	19-20 MM	AD 21 - 038 11.5 mm			ADO-A-05	5 MM	37 MM
AD 21 - 035 28.5 mm			ADO-A-06	4 MM	21 MM	AD 21 - 038 11.5 mm			ADO-A-06	4 MM	38 MM
AD 21 - 035 28.5 mm			ADO-A-07	3 MM	22 MM	AD 21 - 038 11.5 mm			ADO-A-07	3 MM	39 MM
AD 21 - 035 28.5 mm			ADO-A-08	2 MM	23 MM	AD 21 - 038 11.5 mm			ADO-A-08	2 MM	40 MM
AD 21 - 036 23.5 mm			ADO-A-05	5 MM	24-25 MM						
AD 21 - 036 23.5 mm			ADO-A-06	4 MM	26 MM						
AD 21 - 036 23.5 mm			ADO-A-07	3 MM	27 MM						
AD 21 - 036 23.5 mm			ADO-A-08	2 MM	28 MM						

Uyarı: Profil ağırlıklarımız teorik olup; teslim anındaki tartımız geçerlidir.

AD 61 T YALITIMLI DOĞRAMA SİSTEMİ PROFİLLERİ

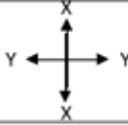
AD 61 T YALITIMLI DOĞRAMA SİSTEMİ ATALET MOMENTİ TABLOSU (IXX cm ²)													
	800 mm	1000 mm	1200 mm	1400 mm	1600 mm	1800 mm	2000 mm	2200 mm	2400 mm	2600 mm	2800 mm	3000 mm	3500 mm
	AD31-015	11,53	13,50	15,00	16,13	16,98	17,63	18,13	18,52	18,83	19,09	19,29	19,46
AD31-016	12,75	15,04	16,83	18,20	19,25	20,07	20,70	21,20	21,60	21,92	22,18	22,40	22,81
AD31-017	13,89	16,50	18,58	20,21	21,47	22,46	23,23	23,85	24,35	24,75	25,08	25,36	25,87
AD31-018	15,38	18,41	20,90	22,89	24,46	25,70	26,69	27,48	28,12	28,65	29,08	29,44	30,12
AD31-019	18,76	22,72	26,16	29,05	31,42	33,35	34,93	36,22	37,28	38,16	38,90	39,52	40,69
AD31-021	50,71	58,58	65,43	71,18	75,92	79,78	82,94	85,53	87,66	89,43	90,91	92,15	94,50
AD31-022	91,77	103,93	114,95	124,52	132,63	139,42	145,08	149,79	153,72	157,02	159,81	162,17	166,69
AD31-034	15,66	18,86	21,51	23,65	25,35	26,70	27,78	28,66	29,36	29,94	30,42	30,82	31,58
AD31-045	12,92	15,36	17,27	18,74	19,87	20,75	21,44	21,98	22,41	22,77	23,06	23,30	23,74
AD31-046	14,35	17,18	19,47	21,27	22,68	23,80	24,67	25,37	25,94	26,40	26,78	27,10	27,69
AD31-047	16,88	20,42	23,42	25,88	27,87	29,48	30,77	31,82	32,68	33,39	33,98	34,47	35,40
AD31-048	20,17	24,57	28,52	31,91	34,77	37,14	39,10	40,73	42,09	43,22	44,18	44,98	46,52
AD31-050	58,84	68,21	76,70	84,08	90,33	95,56	99,92	103,56	106,60	109,14	111,29	113,12	116,60
AD31-051	106,99	121,21	134,62	146,69	157,23	166,29	174,01	180,57	186,13	190,86	194,90	198,35	205,05

AD 61 T ORTA KAYIT BAĞLANTI KOMBİNASYON TABLOSU		
PROFİL KODU	1. BAĞLANTI PROFİL KODU	2. BAĞLANTI PROFİL KODU
AD31-001	AD21-074	AD21-075
AD31-002	AD21-074	AD21-075
AD31-003	AD21-074	AD21-075
AD31-004	AD21-074	AD21-075
AD31-005	AD21-074	AD21-075
AD31-006	AD21-074	AD21-075
AD31-007	AD21-074	AD21-076
AD31-008	AD21-074	AD21-076
AD31-009	AD21-074	AD21-076
AD31-010	AD21-074	AD21-076
AD31-011	AD21-074	AD21-076
AD31-012	AD21-074	AD21-076
AD31-013	AD21-074	AD21-076
AD31-014	AD21-074	AD21-076
AD31-015	AD21-074	AD21-075
AD31-016	AD21-074	AD21-075
AD31-017	AD21-074	AD21-075
AD31-018	AD21-074	AD21-075
AD31-019	AD21-074	AD21-075
AD31-020	AD21-074	AD21-075
AD31-021	AD21-074	AD21-075
AD31-022	AD21-074	AD21-075
AD31-023	AD21-074	AD21-076
AD31-030	AD21-074	AD21-075
AD31-031	AD21-074	AD21-076
AD31-032	AD21-074	AD21-076
AD31-033	AD21-074	AD21-076
AD31-034	AD21-074	AD21-075
AD31-035	AD21-074	AD21-075
AD31-036	AD21-074	AD21-075
AD31-037	AD21-074	AD21-075
AD31-038	AD21-074	AD21-075
AD31-039	AD21-074	AD21-075
AD31-040	AD21-074	AD21-076
AD31-041	AD21-074	AD21-076
AD31-042	AD21-074	AD21-076
AD31-043	AD21-074	AD21-076
AD31-044	AD21-074	AD21-076
AD31-045	AD21-074	AD21-075
AD31-046	AD21-074	AD21-075
AD31-047	AD21-074	AD21-075
AD31-048	AD21-074	AD21-075
AD31-049	AD21-074	AD21-075
AD31-050	AD21-074	AD21-075
AD31-051	AD21-074	AD21-075

AD 61 T YALITIMLI DOĞRAMA SİSTEMİ PROFİLLERİ

AD 61 T YALITIMLI SERİ			
PROFİL KODU	KÖŞE ÇAVUŞU KODU	AÇIKLAMA	ADET
AD31-001	005.002.003.00	KÖŞE ÇAVUŞU 45x18.7	1
AD31-002	005.002.003.00	KÖŞE ÇAVUŞU 45x18.7	1
AD31-003	005.002.003.00	KÖŞE ÇAVUŞU 45x18.7	1
AD31-004	005.002.003.00	KÖŞE ÇAVUŞU 45x18.7	1
AD31-005	005.002.003.00	KÖŞE ÇAVUŞU 45x18.7	2
AD31-006	005.002.003.00	KÖŞE ÇAVUŞU 45x18.7	2
AD31-007	005.002.001.00	KÖŞE ÇAVUŞU 39.7x15.7	1
	005.002.002.00	KÖŞE ÇAVUŞU 35x14.2	1
AD31-008	005.002.001.00	KÖŞE ÇAVUŞU 39.7x15.7	1
	005.002.002.00	KÖŞE ÇAVUŞU 35x14.2	1
AD31-009	005.002.001.00	KÖŞE ÇAVUŞU 39.7x15.7	1
	005.002.002.00	KÖŞE ÇAVUŞU 35x14.2	1
AD31-010	005.002.001.00	KÖŞE ÇAVUŞU 39.7x15.7	1
	005.002.002.00	KÖŞE ÇAVUŞU 35x14.2	1
AD31-011	005.002.001.00	KÖŞE ÇAVUŞU 39.7x15.7	1
	005.002.002.00	KÖŞE ÇAVUŞU 35x14.2	1
AD31-012	005.002.001.00	KÖŞE ÇAVUŞU 39.7x15.7	1
	005.002.002.00	KÖŞE ÇAVUŞU 35x14.2	1
AD31-013	005.002.001.00	KÖŞE ÇAVUŞU 39.7x15.7	1
	005.002.002.00	KÖŞE ÇAVUŞU 35x14.2	1
AD31-014	005.002.001.00	KÖŞE ÇAVUŞU 39.7x15.7	1
	005.002.002.00	KÖŞE ÇAVUŞU 35x14.2	1
AD31-015	005.002.003.00	KÖŞE ÇAVUŞU 45x18.7	2
AD31-016	005.002.003.00	KÖŞE ÇAVUŞU 45x18.7	2
AD31-017	005.002.003.00	KÖŞE ÇAVUŞU 45x18.7	2
AD31-018	005.002.003.00	KÖŞE ÇAVUŞU 45x18.7	2
AD31-019	005.002.003.00	KÖŞE ÇAVUŞU 45x18.7	2
AD31-020	005.002.003.00	KÖŞE ÇAVUŞU 45x18.7	1
AD31-021	005.002.003.00	KÖŞE ÇAVUŞU 45x18.7	2
AD31-022	005.002.003.00	KÖŞE ÇAVUŞU 45x18.7	2
AD31-023	005.002.001.00	KÖŞE ÇAVUŞU 39.7x15.7	1
	005.002.002.00	KÖŞE ÇAVUŞU 35x14.2	1
AD31-026	005.002.003.00	KÖŞE ÇAVUŞU 45x18.7	1
AD31-027	005.002.002.00	KÖŞE ÇAVUŞU 35x14.2	1
AD31-030	005.002.003.00	KÖŞE ÇAVUŞU 45x18.7	1
AD31-031	005.002.001.00	KÖŞE ÇAVUŞU 39.7x15.7	1
	005.002.002.00	KÖŞE ÇAVUŞU 35x14.2	1
AD31-032	005.002.001.00	KÖŞE ÇAVUŞU 39.7x15.7	1
	005.002.002.00	KÖŞE ÇAVUŞU 35x14.2	1
AD31-033	005.002.001.00	KÖŞE ÇAVUŞU 39.7x15.7	1
	005.002.002.00	KÖŞE ÇAVUŞU 35x14.2	1
AD31-034	005.002.003.00	KÖŞE ÇAVUŞU 45x18.7	2
AD31-035	005.002.003.00	KÖŞE ÇAVUŞU 45x18.7	1
AD31-036	005.002.003.00	KÖŞE ÇAVUŞU 45x18.7	1
AD31-037	005.002.003.00	KÖŞE ÇAVUŞU 45x18.7	1
AD31-038	005.002.003.00	KÖŞE ÇAVUŞU 45x18.7	2
AD31-039	005.002.003.00	KÖŞE ÇAVUŞU 45x18.7	2
AD31-040	005.002.001.00	KÖŞE ÇAVUŞU 39.7x15.7	1
	005.002.002.00	KÖŞE ÇAVUŞU 35x14.2	1
AD31-041	005.002.001.00	KÖŞE ÇAVUŞU 39.7x15.7	1
	005.002.002.00	KÖŞE ÇAVUŞU 35x14.2	1
AD31-042	005.002.001.00	KÖŞE ÇAVUŞU 39.7x15.7	1
	005.002.002.00	KÖŞE ÇAVUŞU 35x14.2	1
AD31-043	005.002.001.00	KÖŞE ÇAVUŞU 39.7x15.7	1
	005.002.002.00	KÖŞE ÇAVUŞU 35x14.2	1
AD31-044	005.002.001.00	KÖŞE ÇAVUŞU 39.7x15.7	1
	005.002.002.00	KÖŞE ÇAVUŞU 35x14.2	1
AD31-045	005.002.003.00	KÖŞE ÇAVUŞU 45x18.7	2
AD31-046	005.002.003.00	KÖŞE ÇAVUŞU 45x18.7	2

AD 61 T YALITIMLI DOĞRAMA SİSTEMİ PROFİLLERİ

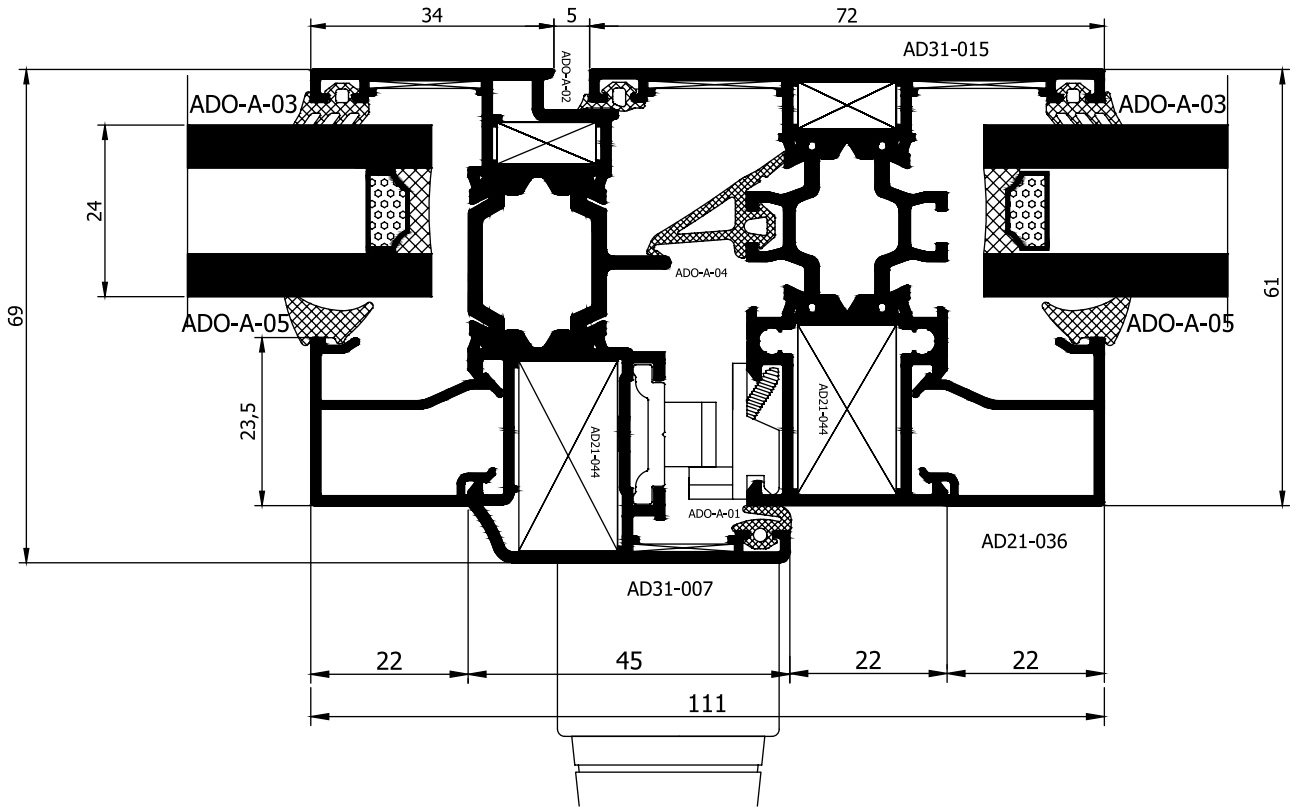
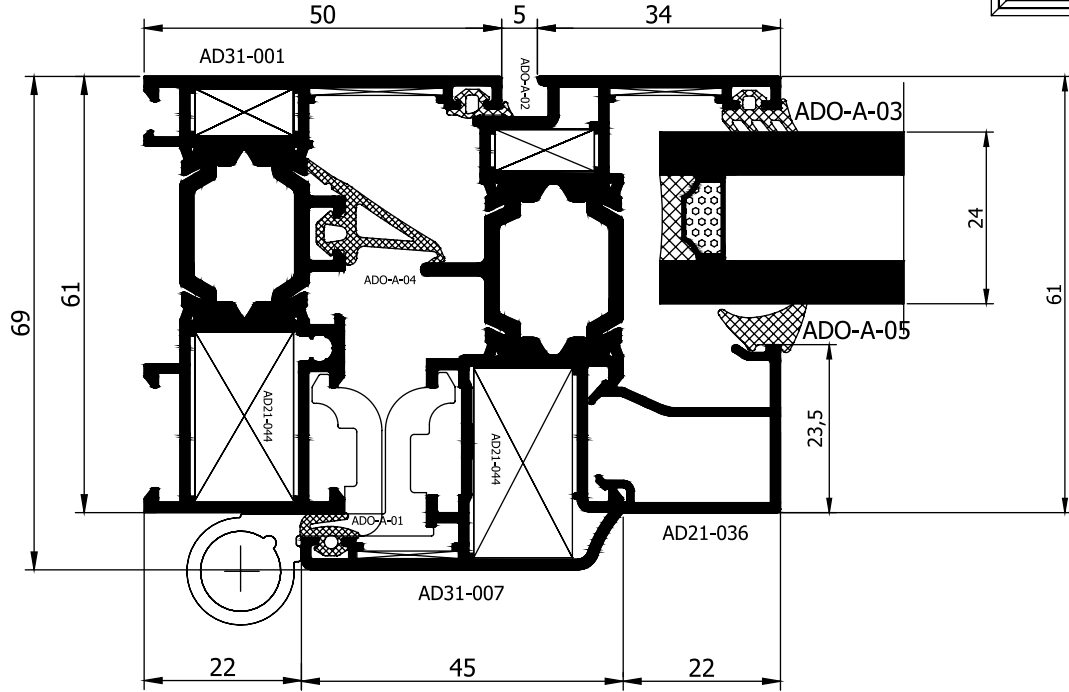
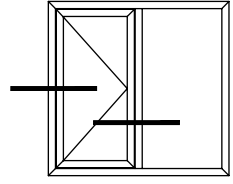

AD 61 T YALITIMLI DOĞRAMA SİSTEMİ PROFİLLERİ

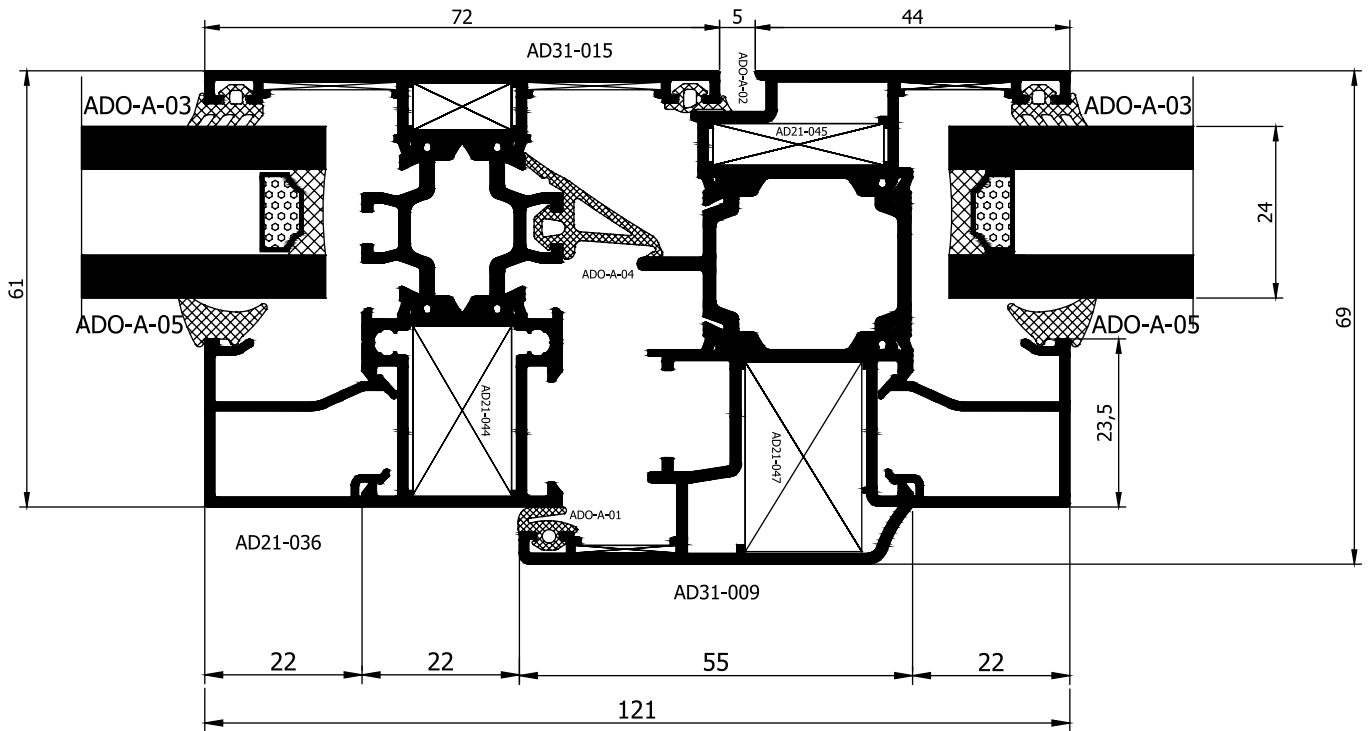
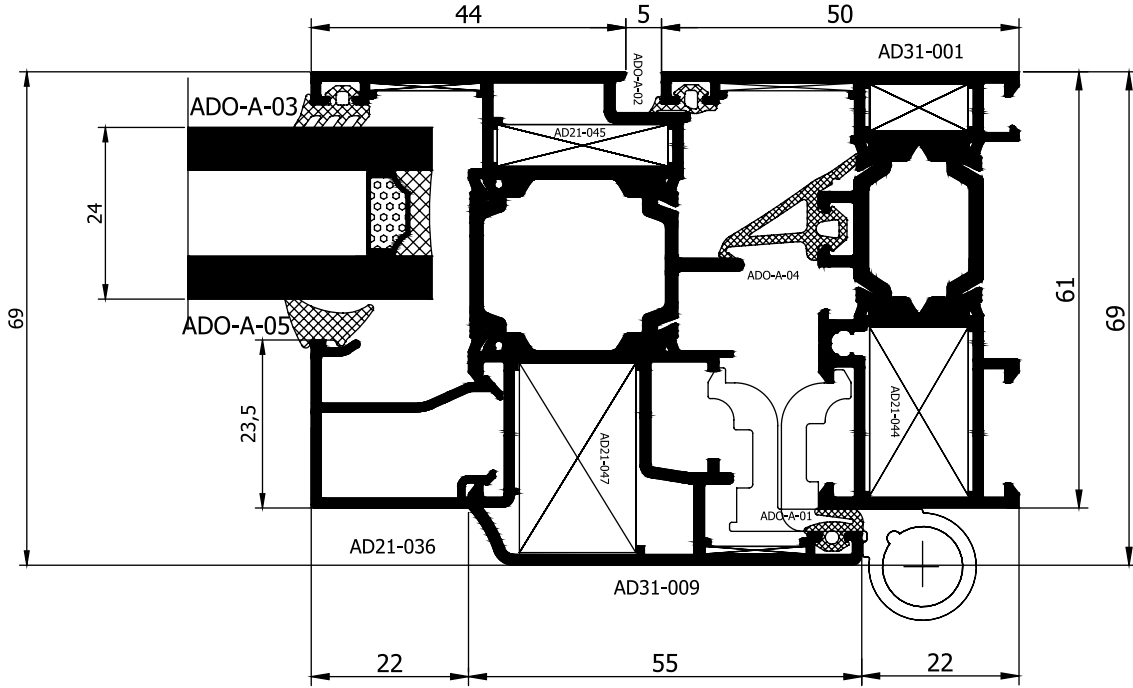
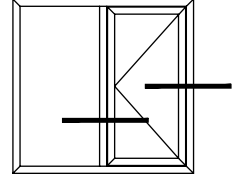

AD 61 T YALITIMLI DOĞRAMA SİSTEMİ PROFİLLERİ

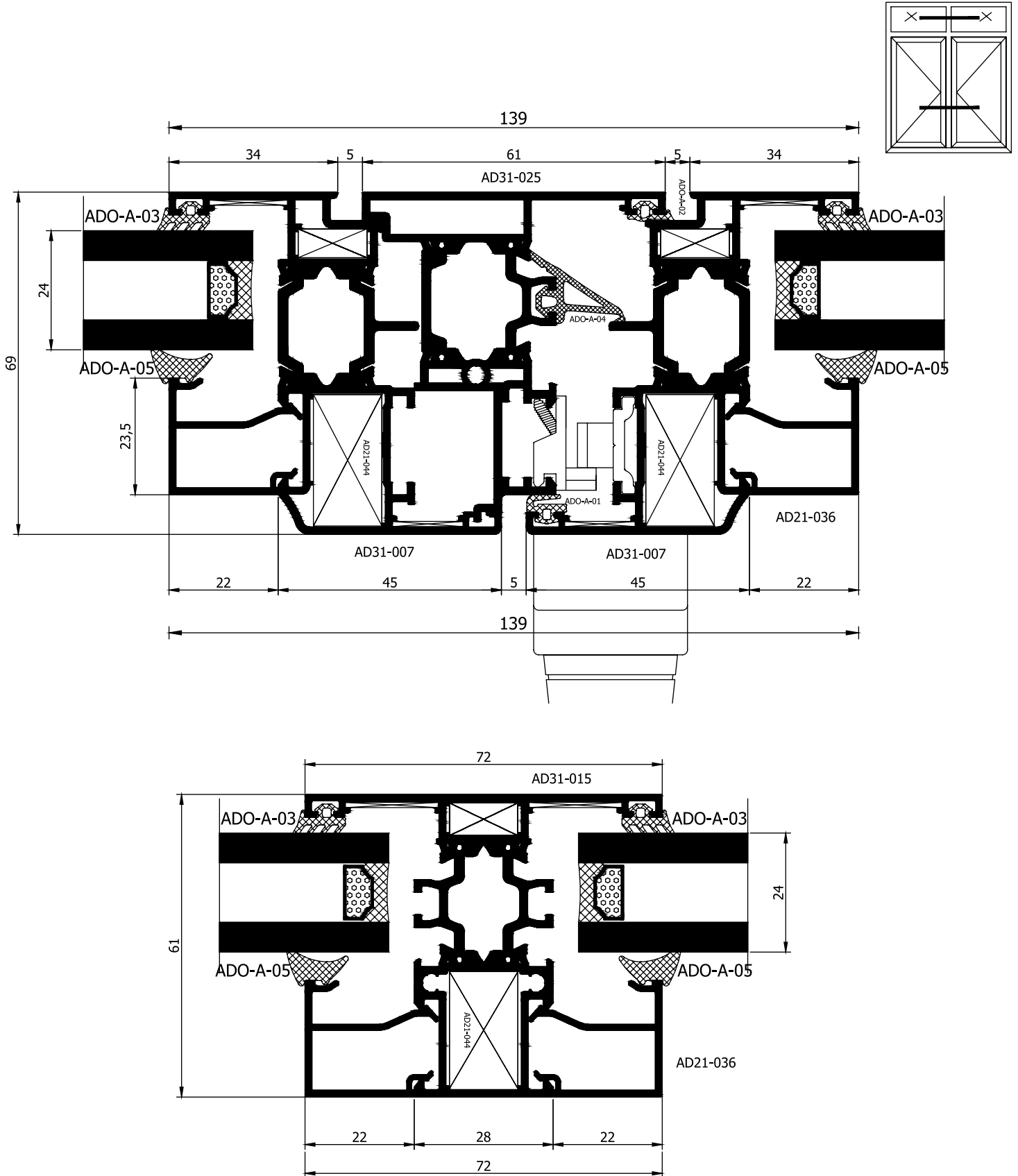

AD 61 T YALITIMLI DOĞRAMA SİSTEMİ PROFİLLERİ

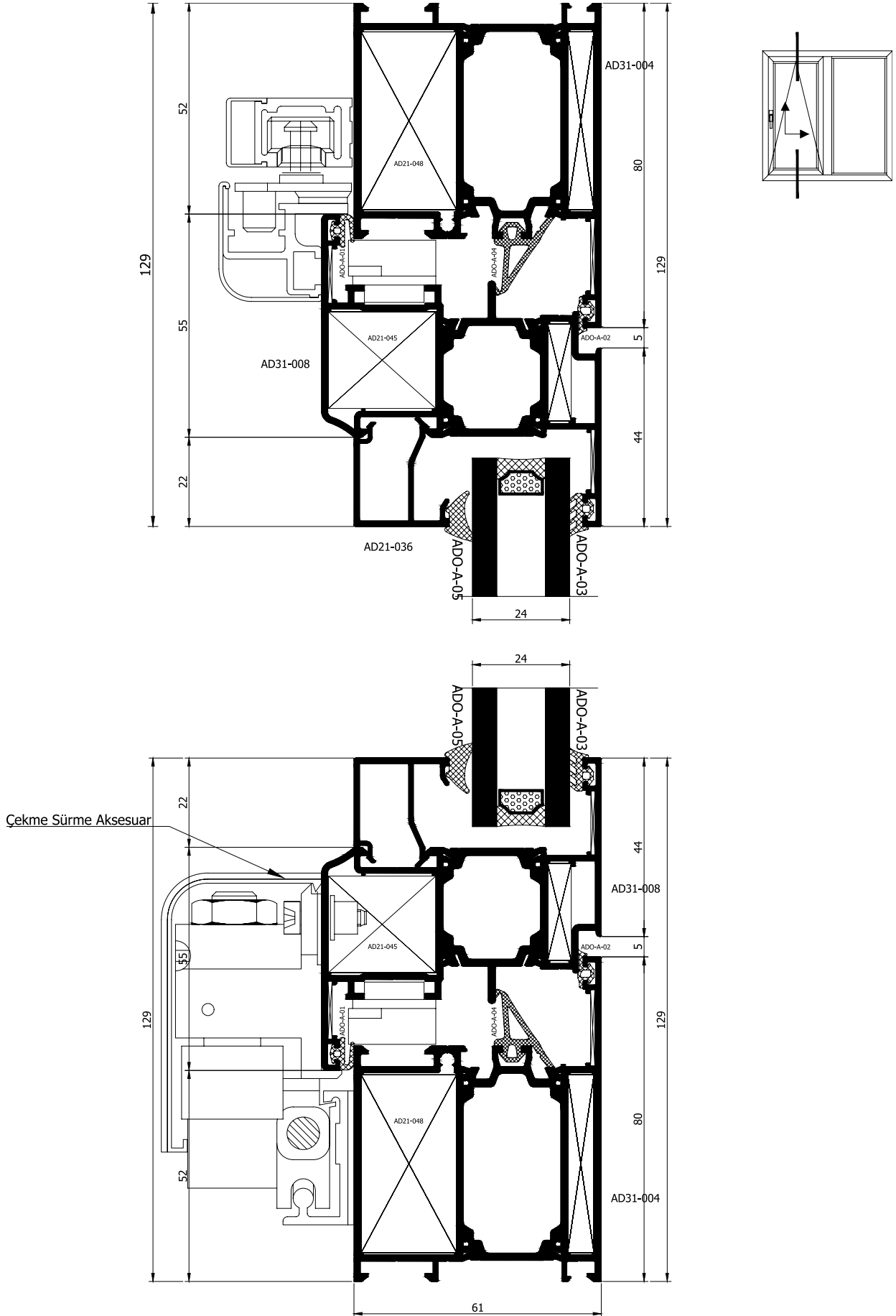

AD 61 T YALITIMLI DOĞRAMA SİSTEMİ PROFİLLERİ

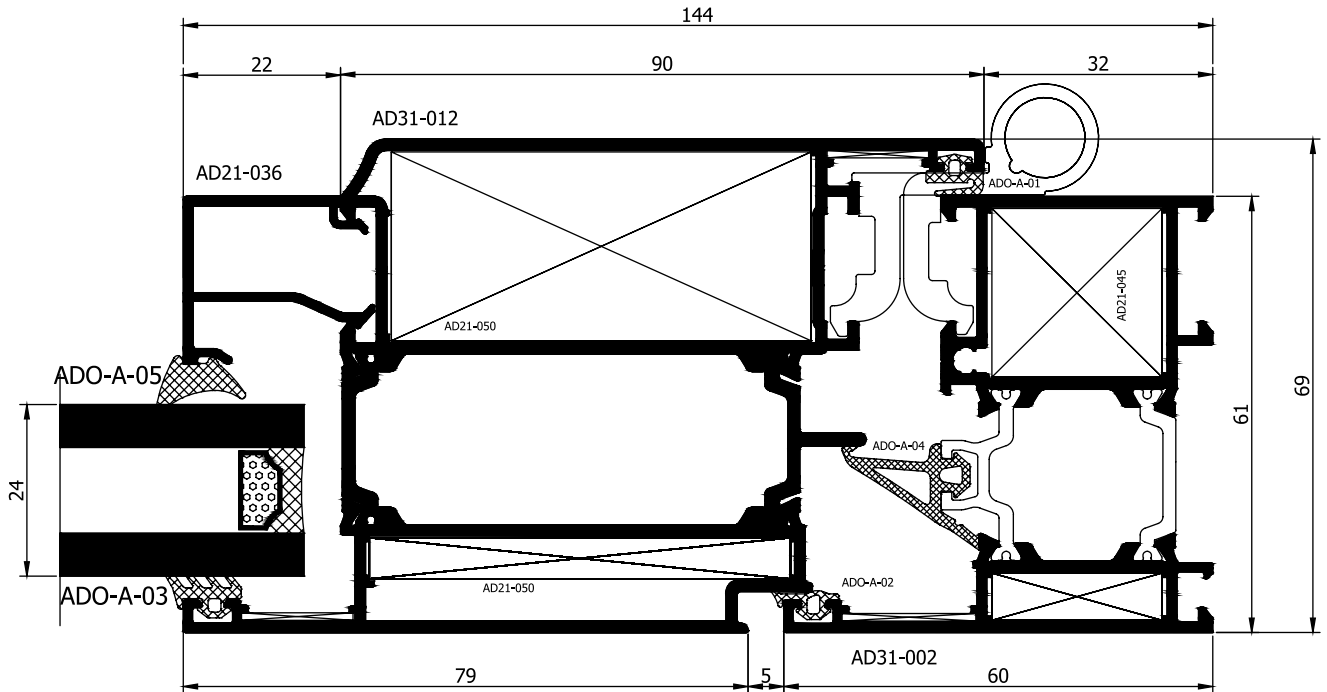
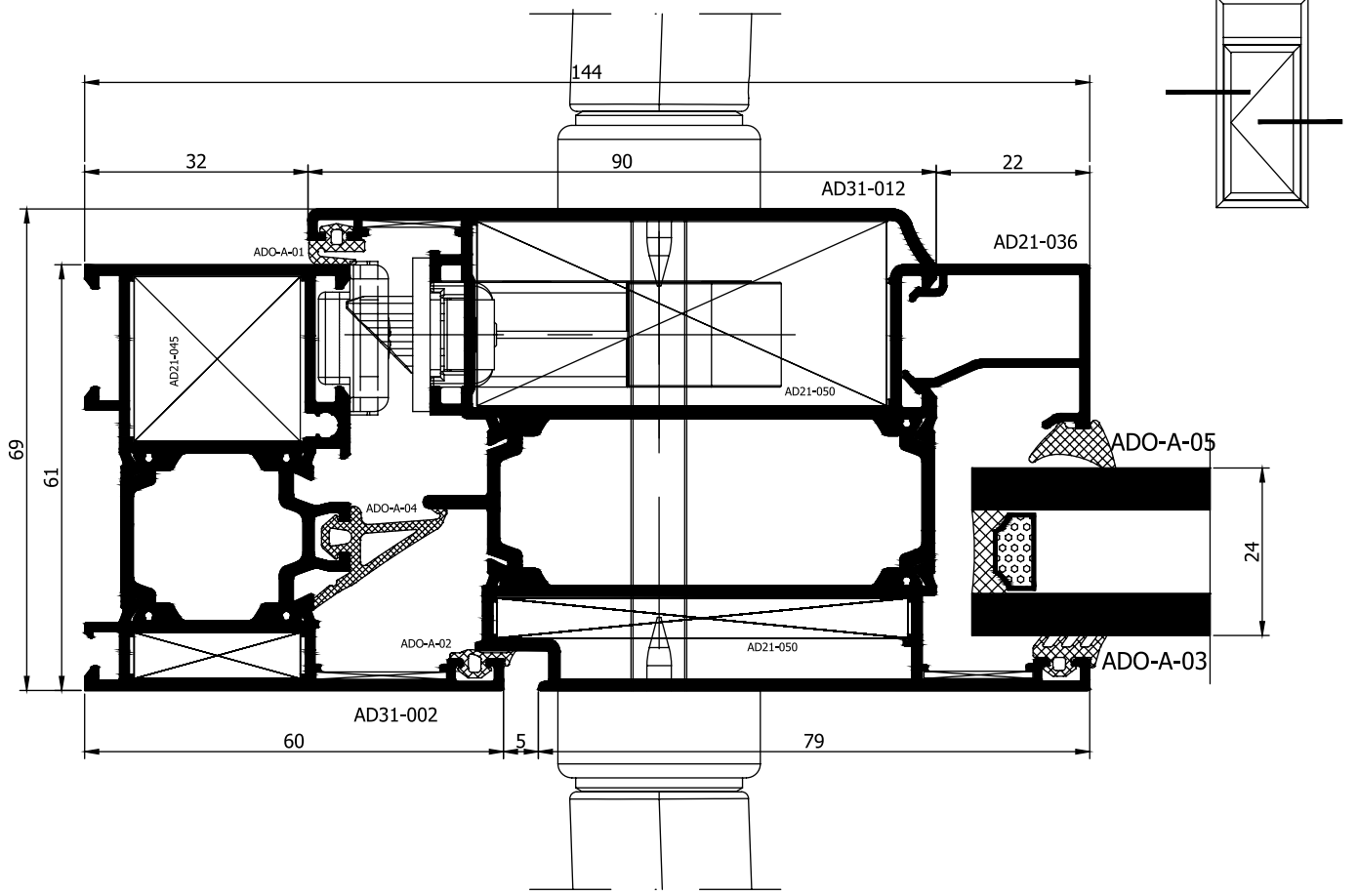

AD 61 T YALITIMLI DOĞRAMA SİSTEMİ PROFİLLERİ

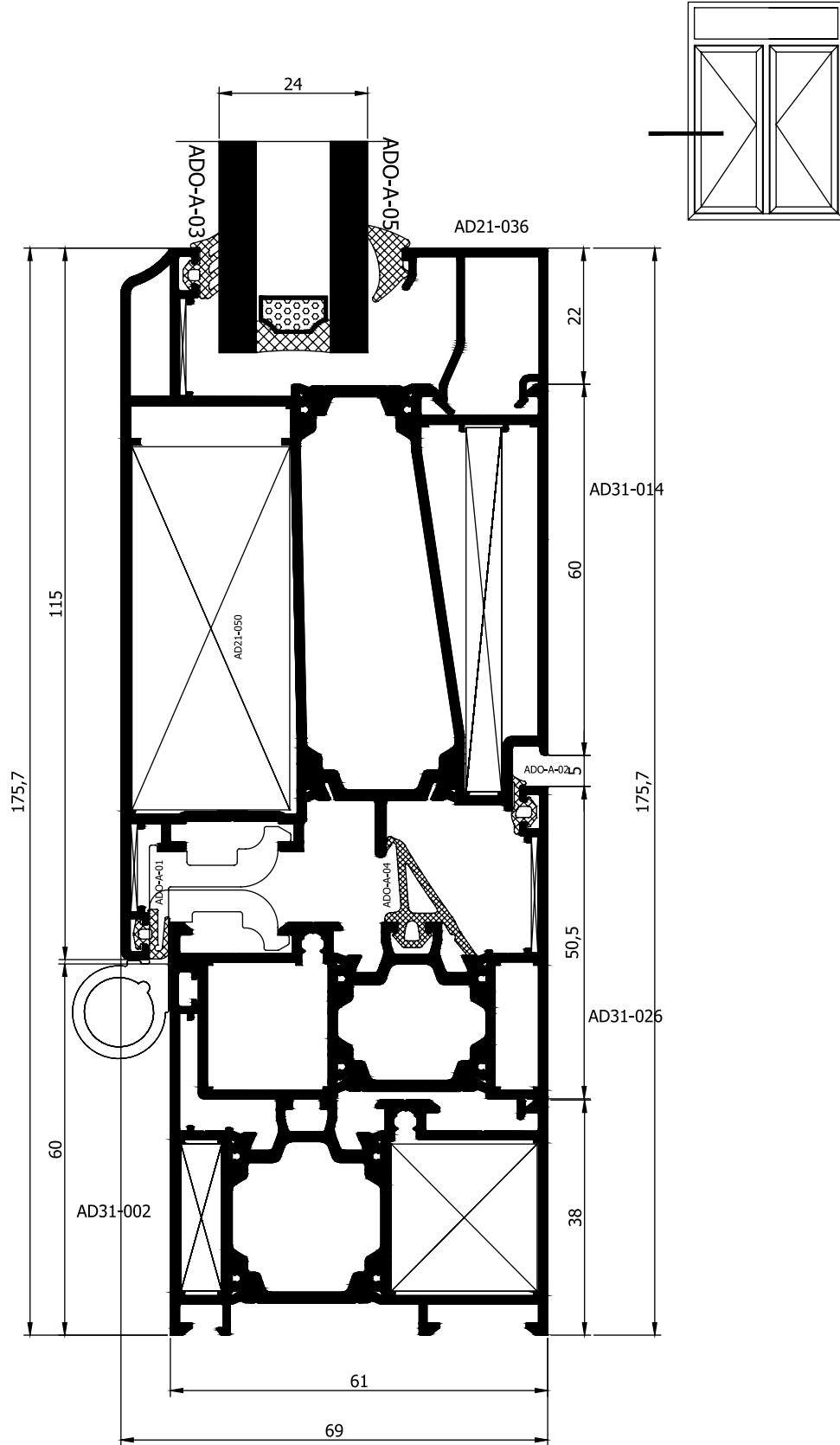

AD 61 T YALITIMLI DOĞRAMA SİSTEMİ PROFİLLERİ

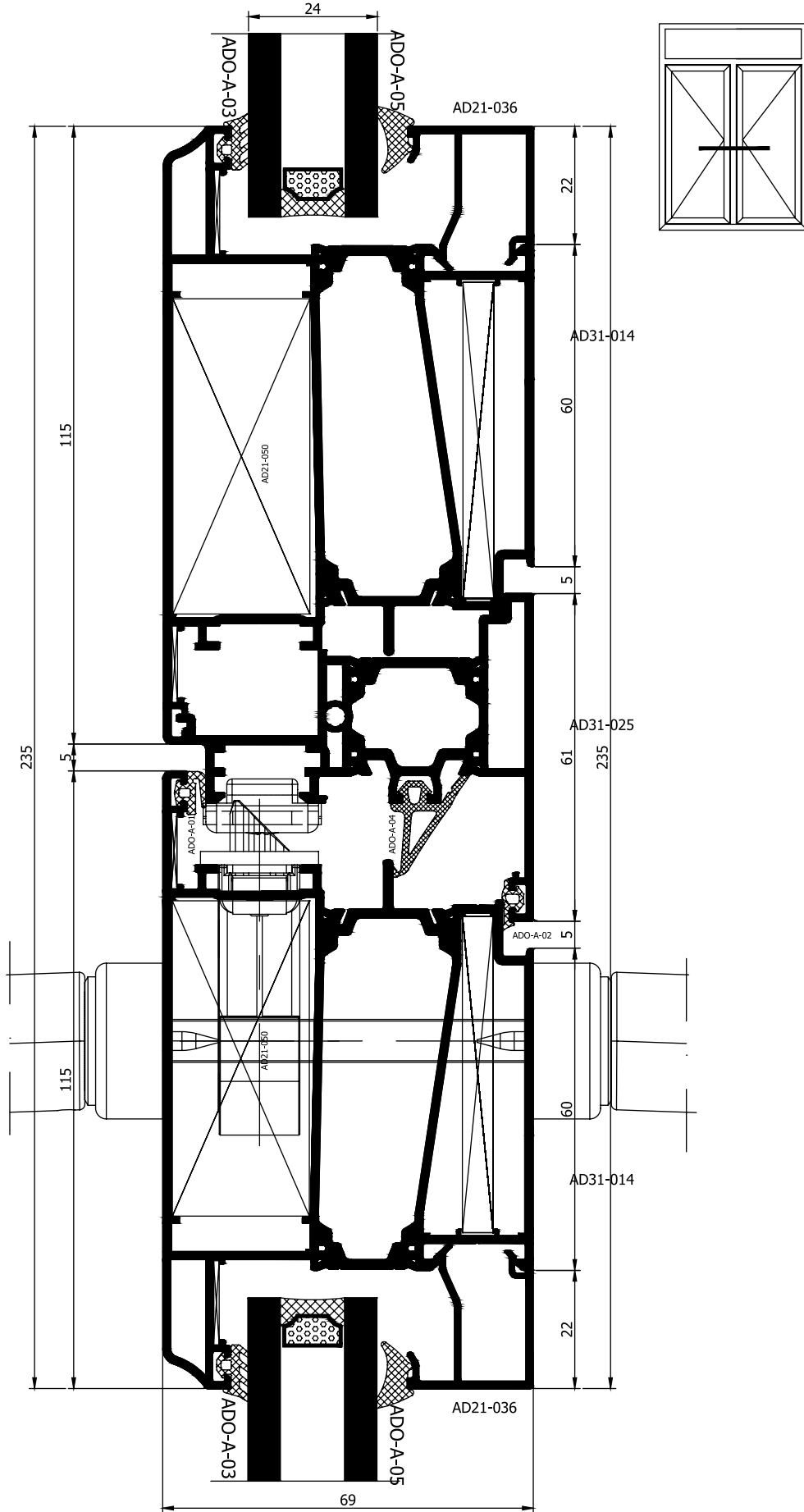

AD 61 T YALITIMLI DOĞRAMA SİSTEMİ PROFİLLERİ

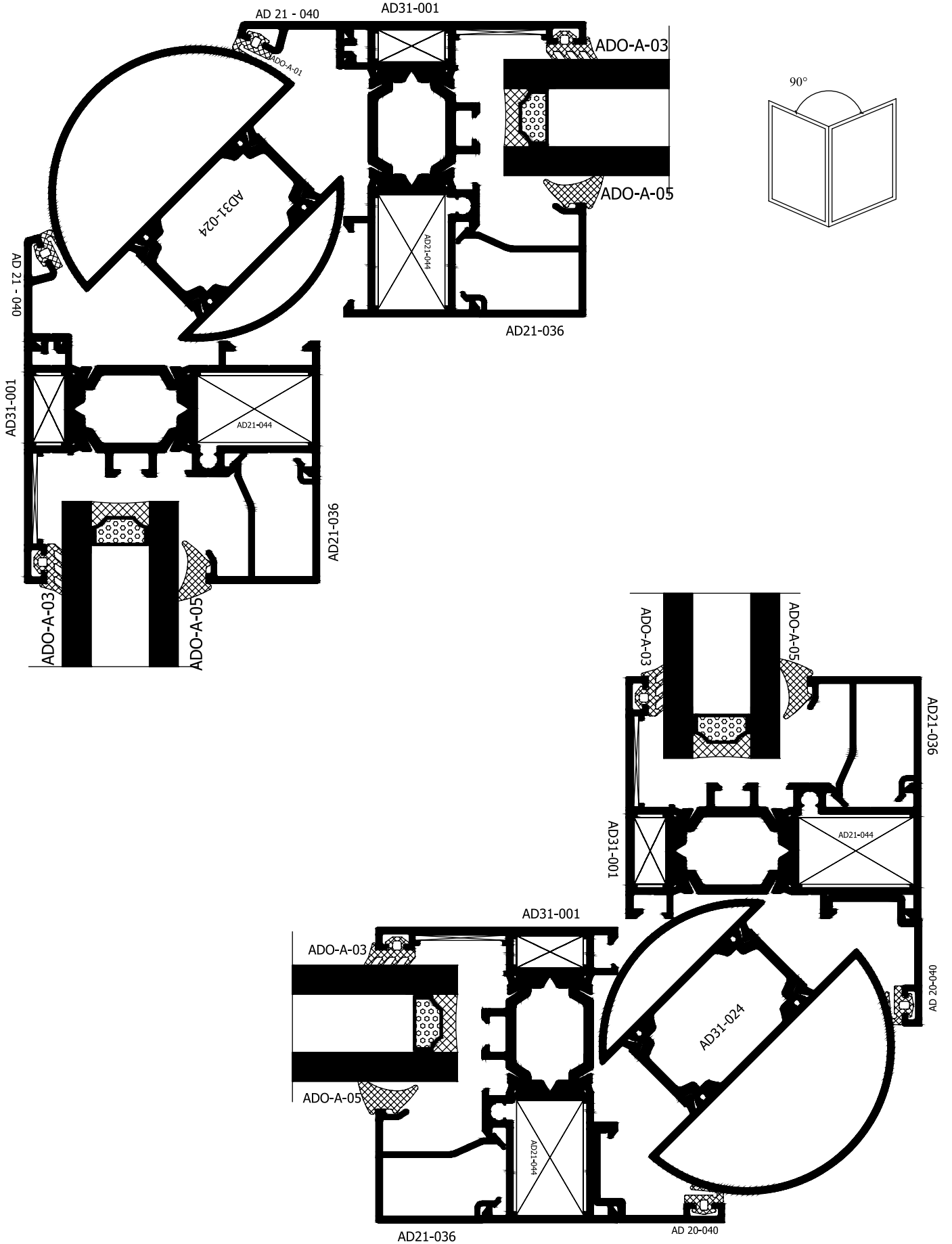

AD 61 T YALITIMLI DOĞRAMA SİSTEMİ PROFİLLERİ

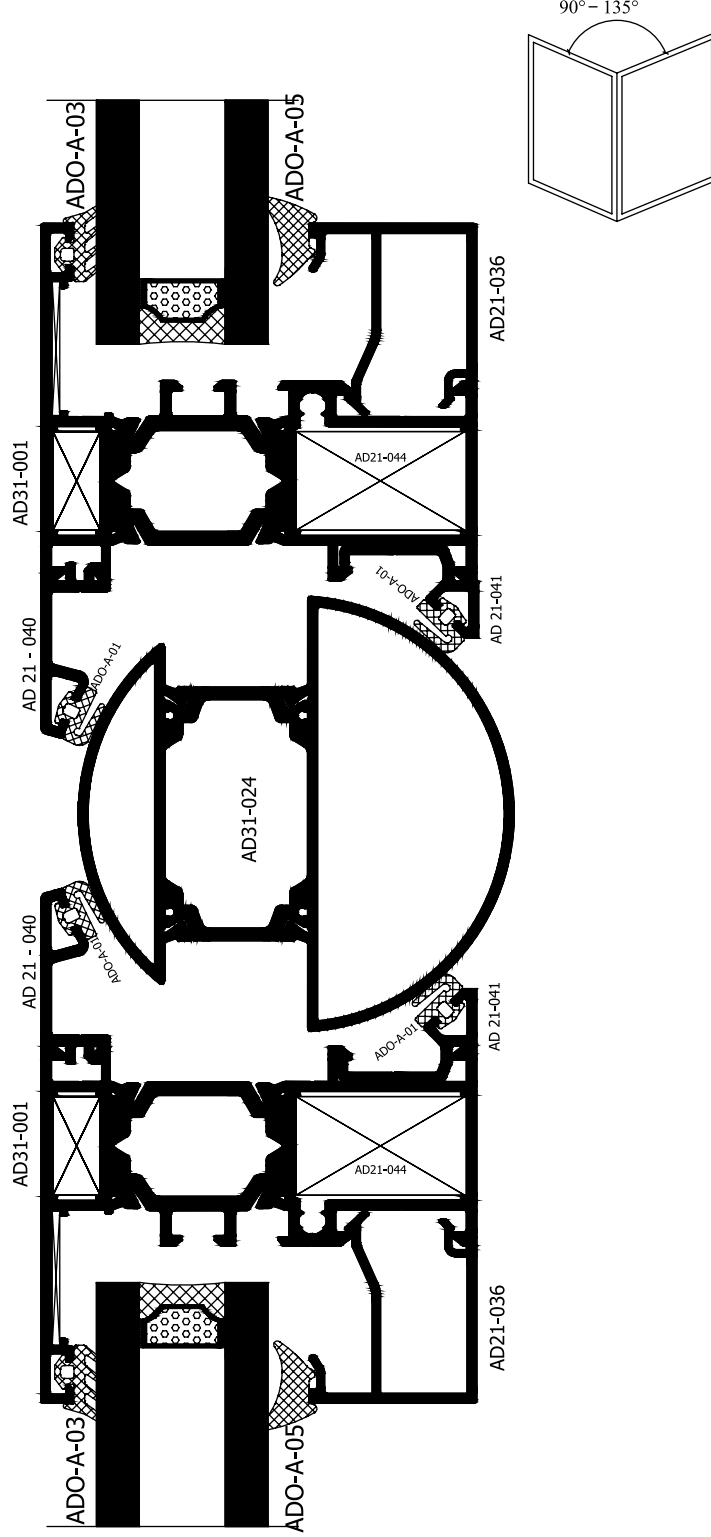

AD 61 T YALITIMLI DOĞRAMA SİSTEMİ PROFİLLERİ

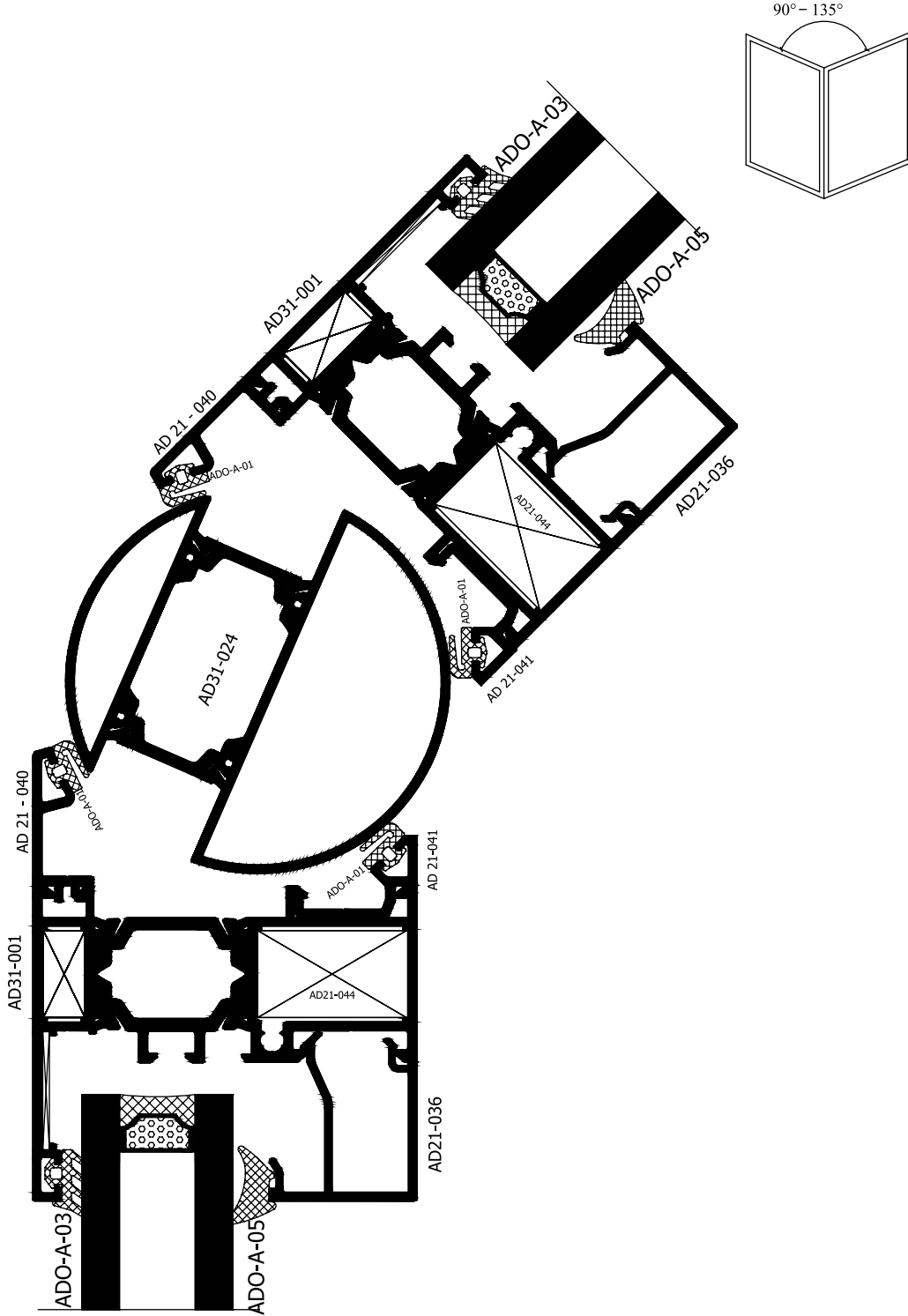





ADO Alüminyum

www.adoaluminyum.com.tr

FABRİKA

Antalya Organize Sanayi Bölgesi 2.Kısım Mah. 21.Cadde No:3 07040 Döşemealtı / ANTALYA
Tel : +90 242 236 40 00 · Faks : +90 242 236 40 90 · Email : info@adoaluminyum.com.tr