

ADO Alüminyum

AD 69 T YALITIMLI DOĞRAMA SİSTEMİ







AD 69 T YALITIMLI DOĞRAMA SİSTEMİ

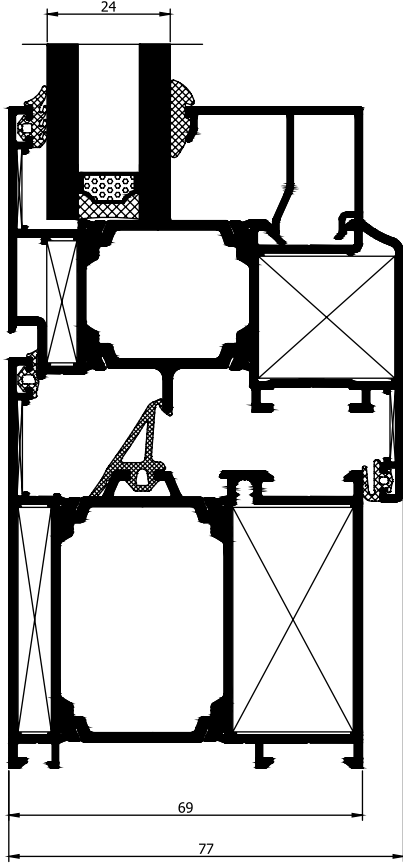

Alüminyum profiller AIMgSi 0,5 - F22 alaşımından ve 12020 Standartlarına göre üretilir.

Fiziksel Özellikler :

| | |
|------------------------|----------------------------------|
| 1- Yoğunluk | : 2,71 kg /dm ³ |
| 2- Elastisite Modülü | : 69 kN /mm ² |
| 3- Direnç | : 20° 33 n Ω .m |
| 4- Erime Noktası | : 600 - 655 ° |
| 5 - Genleşme Katsayısı | : 20 - 100° C μ °C ⁺¹ |

Mekanik Özellikler :

| | |
|-------------------------|--------------|
| 1- Elastisite Limiti | : 190 MPa |
| 2 - Kopma dayanıklılığı | : 220 MPa |
| 3- Sertlik | : 67 Brinell |
| 4- Uzama | : % 10 |

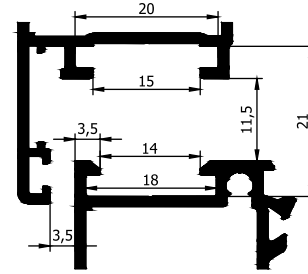

EURO KANAL TİP 1

SİSTEM BİLGİLERİ :

Profil Genişlik : Kasa 69 mm - Kanat 77 mm

Isı Bariyer Ölçüsü : 32 mm

Isı Geçirgenlik değeri (Uf) : 1.804 W/m²K

Fitil (Conta) : Tüm fitiller Kaucuk Özellikli EPDM dir.











Yapılabilir Pencere Tipleri : İçe açılır - Çift açılır - Çift Kanat açılır - Woswagen Pencere - pencere tipleri ile İçe açılır Kapı - Dışa açılı Kapılar.

Kullanılabilir Cam Kalınlığı : 18 mm cam dan 48 mm Isıcam kalınlığına kadar EPDM fitil kalınlıkları ve ölçüsüne uygun cam çıtası ile ayarlanak istenilen ısıcam kullanım imkanı sunmaktadır.

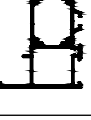
Su Tahliye : Bütün Profiller Su tahliye sistemine sahiptir.

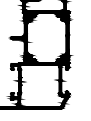
Bağlantılar : Köşe birleşimlerini sağlamak için Pres Köşe takoz bağlantıları ve Çene L parçaları kullanılarak preslenir. Orta Kayıtlar dış kasadan vida atılarak ve iç kısımdan takozları ile bağlanır.

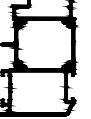





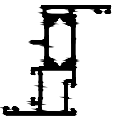
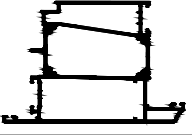
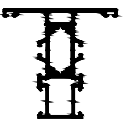
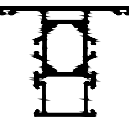
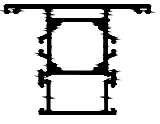
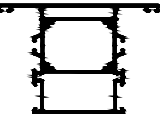
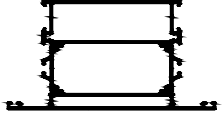
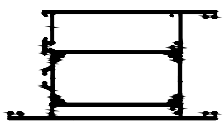
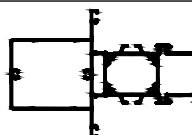
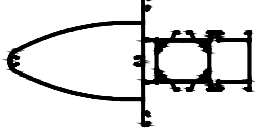
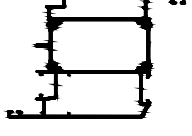
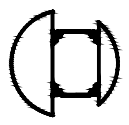

AD 69 T YALITIMLI DOĞRAMA SİSTEMİ PROFİLLERİ

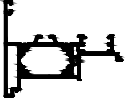
| No: | Profil Şekli | Profil Kod | Profil Adı | Profil Ağırlık (Kg/m) | | |
|-----|---|------------|---|----------------------------|--|--|
| 1 |  | AD32-001 | KASA PROFİLİ | 1,234 Kg/m | | |
| 2 |  | AD32-002 | KASA PROFİLİ | 1,397 Kg/m | | |
| 3 |  | AD32-003 | KASA PROFİLİ | 1,559 Kg/m | | |
| 4 |  | AD32-004 | KASA PROFİLİ | 1,769 Kg/m | | |
| 5 |  | AD32-005 | PERVAZLI KASA PROFİLİ | 1,334 Kg/m | | |
| 6 |  | AD32-006 | PERVAZLI KASA PROFİLİ | 1,614 Kg/m | | |
| 7 |  | AD32-007 | KANAT PROFİLİ | 1,347 Kg/m | | |
| 8 |  | AD32-008 | KANAT PROFİLİ | 1,509 Kg/m | | |
| 9 |  | AD32-009 | PVC AKSESUAR UYUMLU KANAT PROFİLİ | 1,529 Kg/m | | |
| 10 |  | AD32-010 | KANAT PROFİLİ | 1,720 Kg/m | | |
| 11 |  | AD32-011 | KANAT PROFİLİ | 1,888 Kg/m | | |
| 12 |  | AD32-012 | KANAT PROFİLİ | 2,139 Kg/m | | |

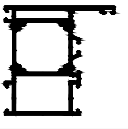
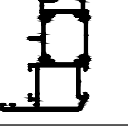
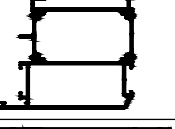
AD 69 T YALITIMLI DOĞRAMA SİSTEMİ PROFİLLERİ

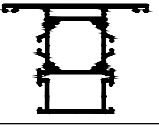
| No: | Profil Şekli | Profil Kod | Profil Adı | Profil Ağırlık (Kg/m) | | |
|-----|---|------------|-----------------------------------|-------------------------|--|--|
| 13 |  | AD32-013 | KANAT PROFİLİ | 1,289 Kg/m | | |
| 14 |  | AD32-014 | BİNİLİ DIŞA AÇILIM KANAT PROFİLİ | 2,308 Kg/m | | |
| 15 |  | AD32-015 | ORTA KAYIT PROFİLİ | 1,389 Kg/m | | |
| 16 |  | AD32-016 | ORTA KAYIT PROFİLİ | 1,551 Kg/m | | |
| 17 |  | AD32-017 | ORTA KAYIT PROFİLİ | 1,715 Kg/m | | |
| 18 |  | AD32-018 | ORTA KAYIT PROFİLİ | 1,929 Kg/m | | |
| 19 |  | AD32-019 | ORTA KAYIT PROFİLİ | 2,485 Kg/m | | |
| 20 |  | AD32-020 | ETEK PROFİLİ | 2,603 Kg/m | | |
| 21 |  | AD32-021 | TAKVİYELİ ORTA KAYIT PROFİLİ | 2,217 Kg/m | | |
| 22 |  | AD32-022 | TAKVİYELİ ORTA KAYIT PROFİLİ | 2,383 Kg/m | | |
| 23 |  | AD32-023 | PVC AKSESUAR UYUMLU KANAT PROFİLİ | 2,154 Kg/m | | |
| 24 |  | AD32-024 | KÖŞE PROFİLİ | 1,331 Kg/m | | |

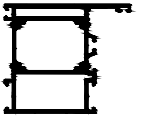



AD 69 T YALITIMLI DOĞRAMA SİSTEMİ PROFİLLERİ

| No: | Profil Şekli | Profil Kod | Profil Adı | Profil Ağırlık (Kg/m) | | |
|-----|---|------------|---|-------------------------|--|--|
| 25 |  | AD32-025 | BİNİLİ KANAT ORTA ADAPTÖR PROFİLİ | 1,310 Kg/m | | |
| 26 |  | AD32-026 | BİNİLİ DIŞA AÇILIM KANAT KASA ADAPTÖR PROFİLİ | 1,217 Kg/m | | |
| 27 |  | AD32-027 | PİVOT PENCERE ADAPTÖRÜ | 1,389 Kg/m | | |
| 28 |  | AD32-030 | KASA PROFİLİ (2 mm) | 1,854 Kg/m | | |
| 29 |  | AD32-031 | KANAT PROFİLİ (2 mm) | 1,784 Kg/m | | |
| 30 |  | AD32-032 | KANAT PROFİLİ (2 mm) | 2,523 Kg/m | | |
| 31 |  | AD32-033 | BİNİLİ DIŞA AÇILIM KANAT PROFİLİ (2 mm) | 2,749 Kg/m | | |
| 32 |  | AD32-034 | ORTA KAYIT PROFİLİ (2 mm) | 2,029 Kg/m | | |
| 33 |  | AD32-035 | KASA PROFİLİ (2 mm) | 1,428 Kg/m | | |
| 34 |  | AD32-036 | KASA PROFİLİ (2 mm) | 1,643 Kg/m | | |
| 35 |  | AD32-037 | KASA PROFİLİ (2 mm) | 2,065 Kg/m | | |
| 36 |  | AD32-038 | PERVAZLI KASA PROFİLİ (2 mm) | 1,558 Kg/m | | |

AD 69 T YALITIMLI DOĞRAMA SİSTEMİ PROFİLLERİ

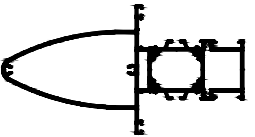
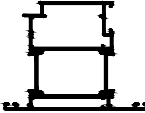
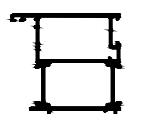
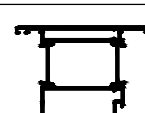
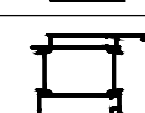
| No: | Profil Şekli | Profil Kod | Profil Adı | Profil Ağırlık (Kg/m) | | |
|-----|--------------|------------|--|-------------------------|--|--|
| 37 | | AD32-039 | PERVAZLI KASA PROFİLİ (2 mm) | 1,886 Kg/m | | |
| 38 | | AD32-040 | KANAT PROFİLİ (2 mm) | 1,575 Kg/m | | |
| 39 | | AD32-041 | PVC AKSESUAR UYUMLU KANAT PROFİLİ (2 mm) | 1,795 Kg/m | | |
| 40 | | AD32-042 | KANAT PROFİLİ (2 mm) | 1,995 Kg/m | | |
| 41 | | AD32-043 | KANAT PROFİLİ (2 mm) | 2,206 Kg/m | | |
| 42 | | AD32-044 | KANAT PROFİLİ (2 mm) | 1,497 Kg/m | | |
| 43 | | AD32-045 | ORTA KAYIT PROFİLİ (2 mm) | 1,606 Kg/m | | |
| 44 | | AD32-046 | ORTA KAYIT PROFİLİ (2 mm) | 1,818 Kg/m | | |
| 45 | | AD32-047 | ORTA KAYIT PROFİLİ (2 mm) | 2,240 Kg/m | | |
| 46 | | AD32-048 | ORTA KAYIT PROFİLİ (2 mm) | 2,875 Kg/m | | |
| 47 | | AD32-049 | ETEK PROFİLİ (2 mm) | 2,995 Kg/m | | |
| 48 | | AD32-050 | TAKVİYELİ ORTA KAYIT PROFİLİ (2 mm) | 2,661 Kg/m | | |

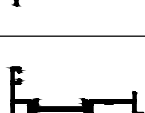

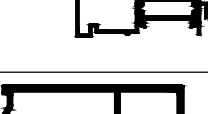
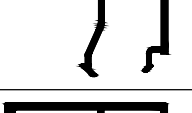
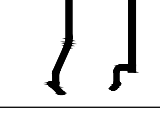
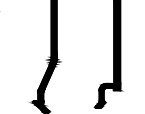





AD 69 T YALITIMLI DOĞRAMA SİSTEMİ PROFİLLERİ

| No: | Profil Şekli | Profil Kod | Profil Adı | Profil Ağırlık (Kg/m) | | |
|-----|---|------------|---|-------------------------|--|--|
| 49 |  | AD32-051 | TAKVİYELİ ORTA KAYIT PROFİLİ (2 mm) | 2,880 Kg/m | | |
| 50 |  | AD32-052 | HEMYÜZ DIŞA AÇILIM KANAT PROFİLİ | 1,796 Kg/m | | |
| 51 |  | AD32-053 | HEMYÜZ İÇE AÇILIM KANAT PROFİLİ | 1,759 Kg/m | | |
| 52 |  | AD32-054 | HEMYÜZ DIŞA AÇILIM KANAT PROFİLİ (2 mm) | 1,966 Kg/m | | |
| 53 |  | AD32-055 | HEMYÜZ İÇE AÇILIM KANAT PROFİLİ (2 mm) | 2,026 Kg/m | | |
| 54 |  | AD32-056 | HEMYÜZ KAPI KASA ADAPTÖR PROFİLİ | 1,039 Kg/m | | |
| 55 |  | AD32-057 | HEMYÜZ İÇE AÇILIM KANAT ORTA ADAPTÖR PROFİLİ | 1,005 Kg/m | | |
| 56 |  | AD32-058 | HEMYÜZ DIŞA AÇILIM KANAT ORTA ADAPTÖR PROFİLİ | 0,976 Kg/m | | |
| 57 |  | AD21-033 | TEK CAM ÇITA PROFİLİ | 0,350 Kg/m | | |
| 58 |  | AD21-034 | TEK CAM ÇITA PROFİLİ | 0,335 Kg/m | | |
| 59 |  | AD21-035 | ISICAM ÇITA PROFİLİ | 0,312 Kg/m | | |
| 60 |  | AD21-036 | ISICAM ÇITA PROFİLİ | 0,295 Kg/m | | |



AD 69 T YALITIMLI DOĞRAMA SİSTEMİ PROFİLLERİ

| No: | Profil Şekli | Profil Kod | Profil Adı | Profil Ağırlık (Kg/m) | | |
|-----|--------------|------------|-----------------------------------|----------------------------|--|--|
| 61 | | AD21-037 | ISICAM ÇITA PROFİLİ | 0,278 Kg/m | | |
| 62 | | AD21-038 | ISICAM ÇITA PROFİLİ | 0,247 Kg/m | | |
| 63 | | AD21-040 | ÇITA PROFİLİ | 0,179 Kg/m | | |
| 64 | | AD21-041 | ÇITA PROFİLİ | 0,140 Kg/m | | |
| 65 | | AD21-087 | ISICAM ÇITA PROFİLİ | 0,252 Kg/m | | |
| 66 | | AD21-044 | KÖŞE TAKOZU | 3,030 Kg/m | | |
| 67 | | AD21-045 | KÖŞE TAKOZU | 3,566 Kg/m | | |
| 68 | | AD21-046 | KÖŞE TAKOZU | 4,157 Kg/m | | |
| 69 | | AD21-047 | KÖŞE TAKOZU | 3,220 Kg/m | | |
| 70 | | AD21-048 | KÖŞE TAKOZU | 5,307 Kg/m | | |
| 71 | | AD21-050 | KÖŞE TAKOZU | 6,366 Kg/m | | |
| 72 | | AD21-042 | ORTA KAYIT BAĞLANTI PROFİLİ | 0,327 Kg/m | | |

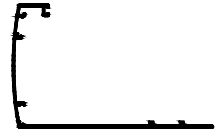
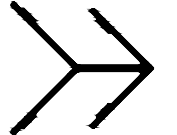
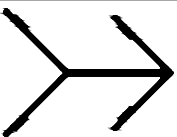
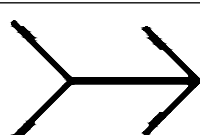



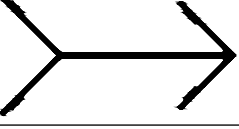
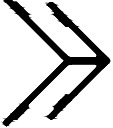



AD 69 T YALITIMLI DOĞRAMA SİSTEMİ PROFİLLERİ

| No: | Profil Şekli | Profil Kod | Profil Adı | Profil Ağırlık (Kg/m) | | |
|-----|---|------------|--|----------------------------|--|--|
| 73 |  | AD21-043 | ORTA KAYIT BAĞLANTI PROFİLİ | 0,347 Kg/m | | |
| 74 |  | AD21-074 | ORTA KAYIT BAĞLANTI PROFİLİ | 0,507 Kg/m | | |
| 75 |  | AD21-075 | ORTA KAYIT BAĞLANTI PROFİLİ | 0,444 Kg/m | | |
| 76 |  | AD21-076 | ORTA KAYIT BAĞLANTI PROFİLİ | 0,423 Kg/m | | |
| 77 |  | AD21-077 | ORTA KAYIT BAĞLANTI PROFİLİ (SETSKURLU) | 0,388 Kg/m | | |
| 78 |  | AD21-080 | MENTEŞE PROFİLİ | 0,575 Kg/m | | |
| 79 |  | AD21-081 | MENTEŞE PROFİLİ | 0,640 Kg/m | | |
| 80 |  | AD20-038 | TİJ PROFİLİ | 0,130 Kg/m | | |
| 81 |  | AD16-029 | PERVAZ PROFİLİ | 1,092 Kg/m | | |
| 82 |  | AD20-048 | VİDALI KÖŞE BAĞLANTI PROFİLİ | 1,079 Kg/m | | |
| 83 |  | AD20-049 | VİDALI KÖŞE BAĞLANTI PROFİLİ | 1,176 Kg/m | | |
| 84 |  | AD20-050 | VİDALI KÖŞE BAĞLANTI PROFİLİ | 1,271 Kg/m | | |

AD 69 T YALITIMLI DOĞRAMA SİSTEMİ PROFİLLERİ

| No: | Profil Şekli | Profil Kod | Profil Adı | Profil Ağırlık (Kg/m) | | |
|-----|---|------------|------------------------------------|----------------------------|--|--|
| 85 |  | AD20-051 | VİDALI KÖŞE BAĞLANTI PROFİLİ | 1,415 Kg/m | | |
| 86 |  | AD20-052 | VİDALI KÖŞE BAĞLANTI PROFİLİ | 0,984 Kg/m | | |
| 87 |  | AD20-053 | VİDALI KÖŞE BAĞLANTI PROFİLİ | 1,016 Kg/m | | |
| 88 | | | | | | |
| 89 | | | | | | |
| 90 | | | | | | |
| 91 | | | | | | |
| 92 | | | | | | |
| 93 | | | | | | |
| 94 | | | | | | |
| 95 | | | | | | |
| 96 | | | | | | |

AD 69 T YALITIMLI DOĞRAMA SİSTEMİ AKSESUARLARI

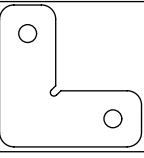
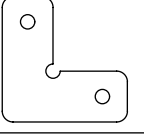
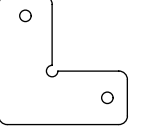
| No: | Şekil | İsim | Kod | Koli Bilgileri | | | |
|-----|---|-----------------------------|----------------------------|----------------|----|--|--|
| | | | | Mt | Kg | | |
| 1 |  | EPDM İç Bini Fiteli | ADO-A-01 020.004.001.03 | 375 | 12 | | |
| 2 |  | EPDM Dış Bini Fiteli | ADO-A-02 020.005.001.03 | 571 | 12 | | |
| 3 |  | EPDM Dış Cam Fiteli | ADO-A-03 020.001.001.03 | 267 | 12 | | |
| 4 |  | EPDM Orta Fiteli | ADO-A-04 020.003.001.03 | 126 | 12 | | |
| 5 |  | EPDM Çıta Fiteli | ADO-A-05 020.002.001.03 | 197 | 12 | | |
| 6 |  | EPDM Çıta Fiteli | ADO-A-06 020.002.002.03 | 164 | 12 | | |
| 7 |  | EPDM Çıta Fiteli | ADO-A-07 020.002.003.03 | 197 | 12 | | |
| 8 |  | EPDM Çıta Fiteli | ADO-A-08 020.002.004.03 | 255 | 12 | | |
| 9 |  | EPDM Çıta Fiteli | ADO-A-09 020.002.005.03 | 240 | 12 | | |
| 10 |  | SAC KÖŞE GÖNYE 39,7x15,7 | 005.002.001.00 | | | | |
| 11 |  | SAC KÖŞE GÖNYE 35x14,2 | 005.002.002.00 | | | | |
| 12 |  | SAC KÖŞE GÖNYE 45x18,7 | 005.002.003.00 | | | | |

AD 69 T YALITIMLI DOĞRAMA PROFİLLERİ

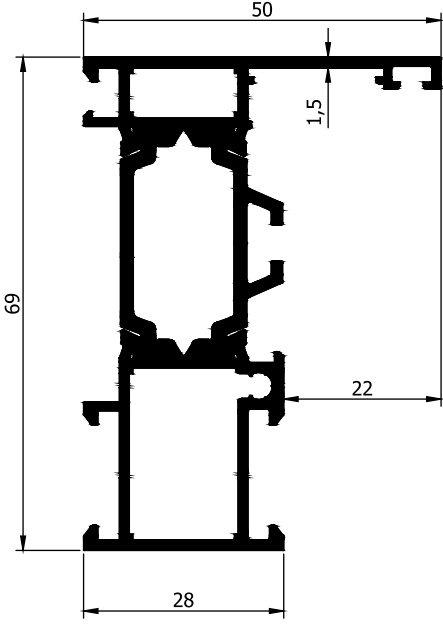

AD32-001
1,234 Kg/m

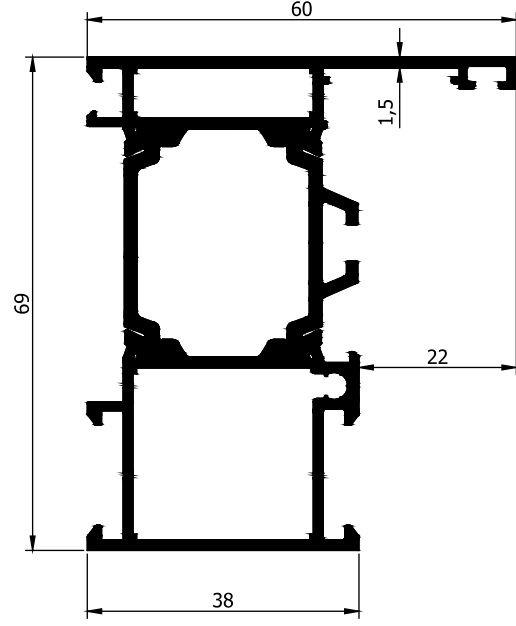

AD32-002
1,397 Kg/m

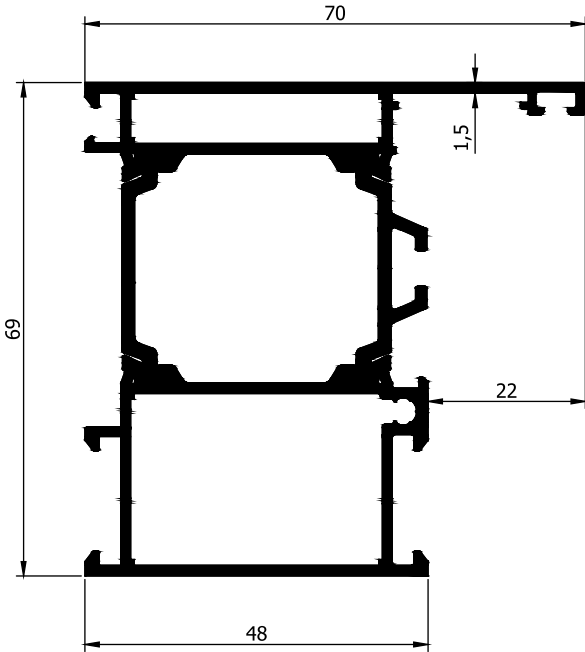

AD32-003
1,559 Kg/m

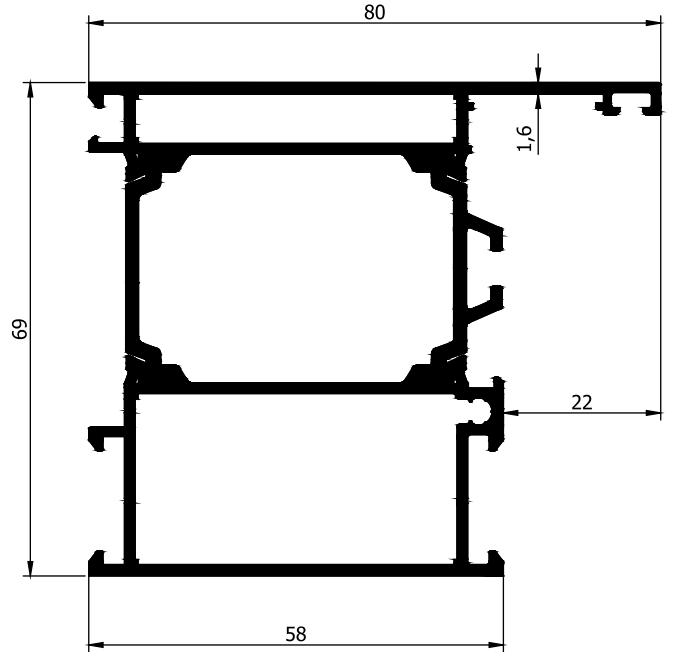

AD32-004
1,769 Kg/m

Uyarı: Profil ağırlıklarımız teorik olup; teslim anındaki tartımız geçerlidir.

AD 69 T YALITIMLI DOĞRAMA PROFİLLERİ

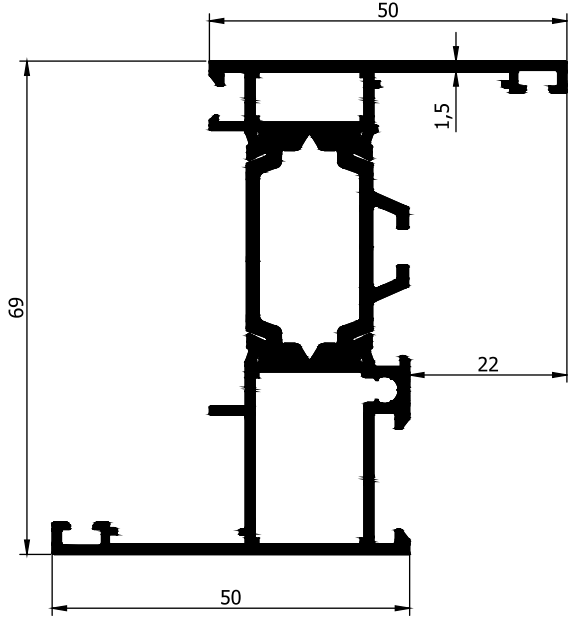

AD32-005
1,334 Kg/m

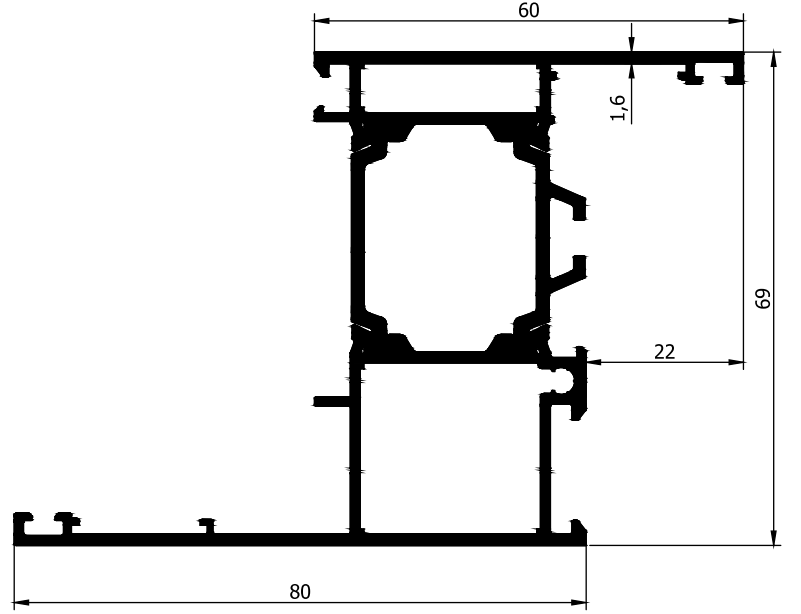

AD32-006
1,614 Kg/m

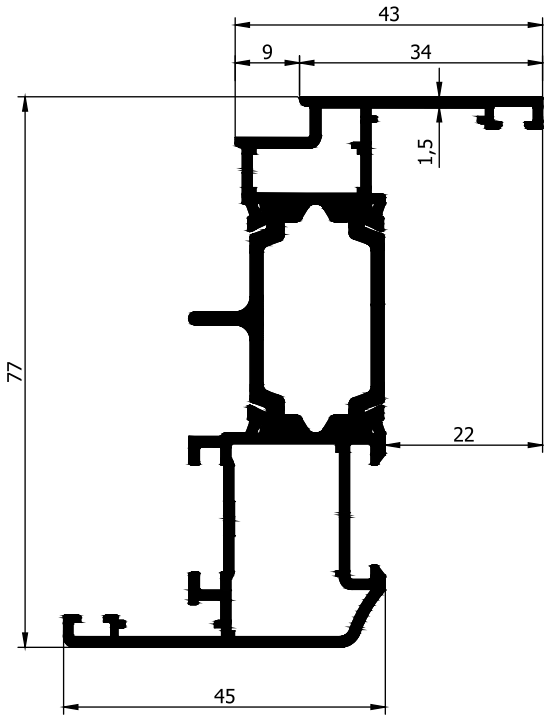

AD32-007
1,347 Kg/m

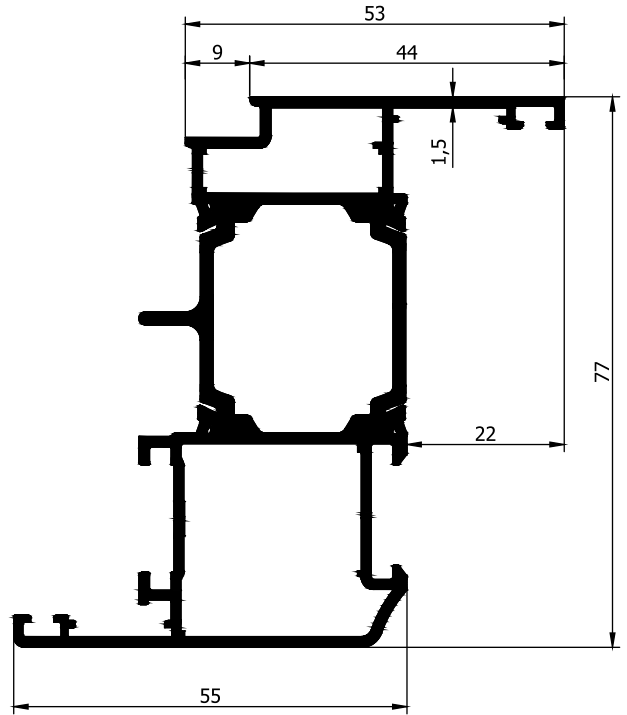

AD32-008
1,509 Kg/m

Uyarı: Profil ağırlıklarımız teorik olup; teslim anındaki tartımız geçerlidir.

AD 69 T YALITIMLI DOĞRAMA PROFİLLERİ

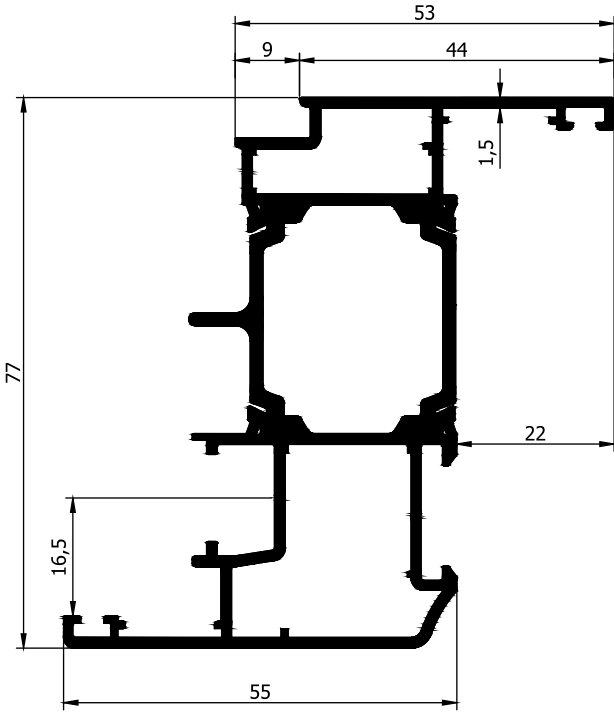

AD32-009
1,529 Kg/m

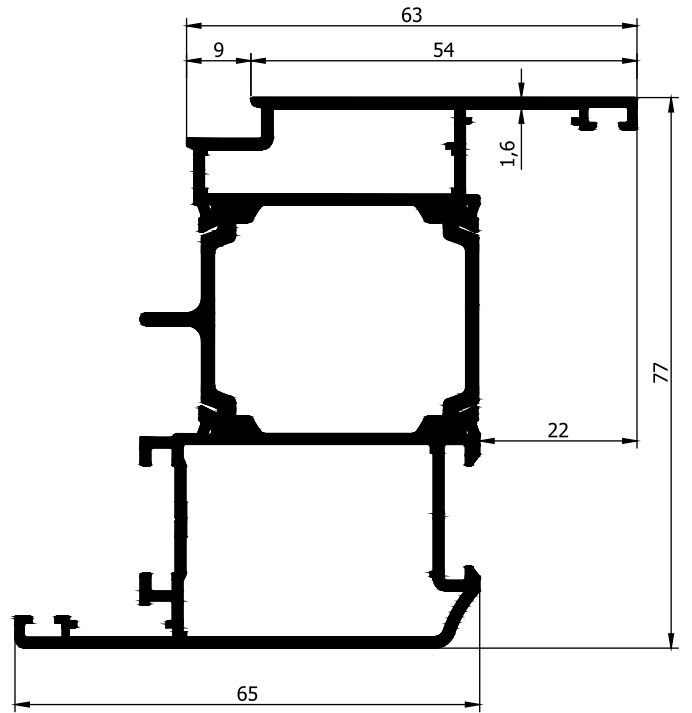

AD32-010
1,720 Kg/m

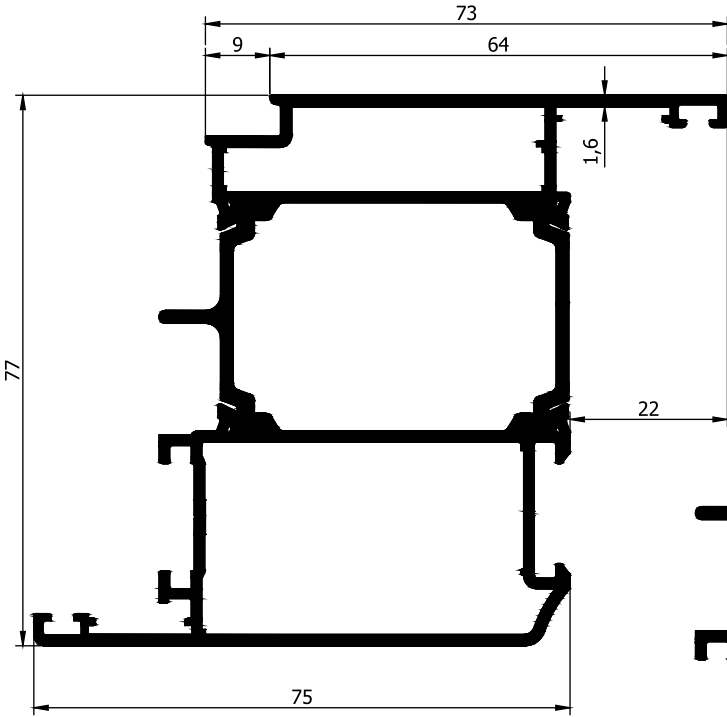

AD32-011
1,888 Kg/m

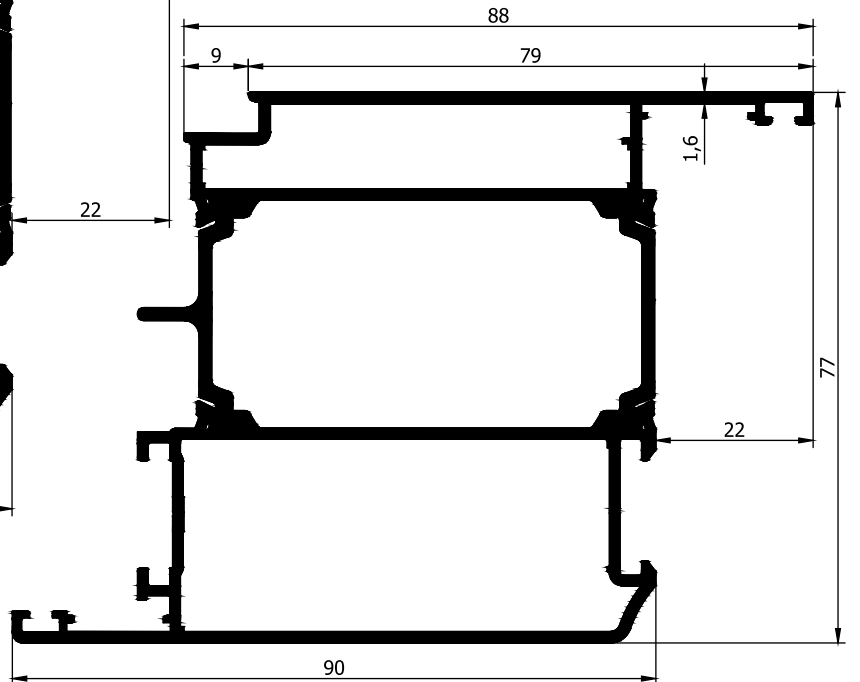

AD32-012
2,139 Kg/m

Uyarı: Profil ağırlıklarımız teorik olup; teslim anındaki tartımız geçerlidir.

AD 69 T YALITIMLI DOĞRAMA PROFİLLERİ

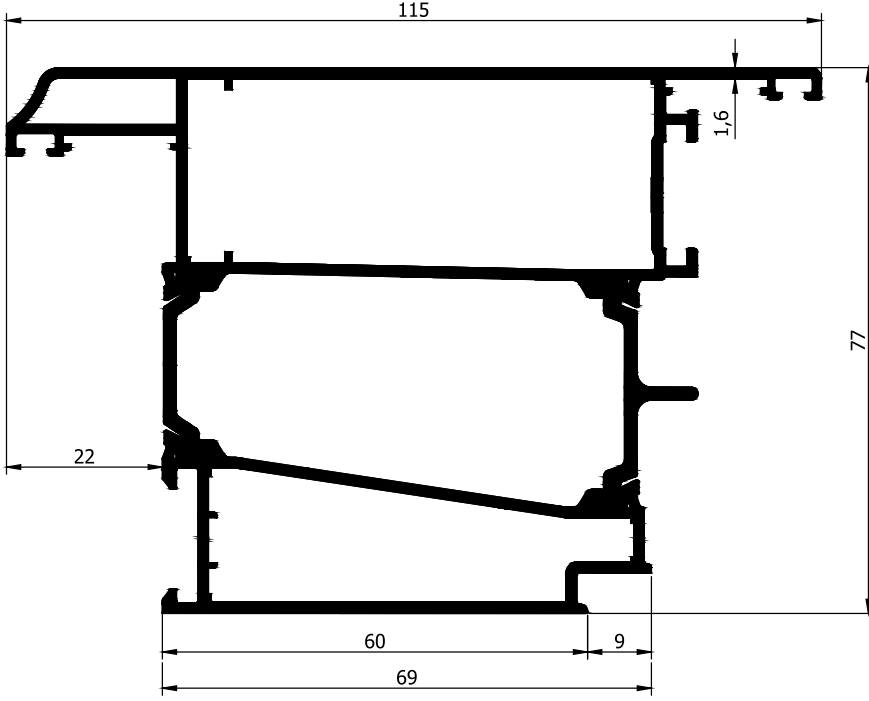

AD32-014
2,308 Kg/m

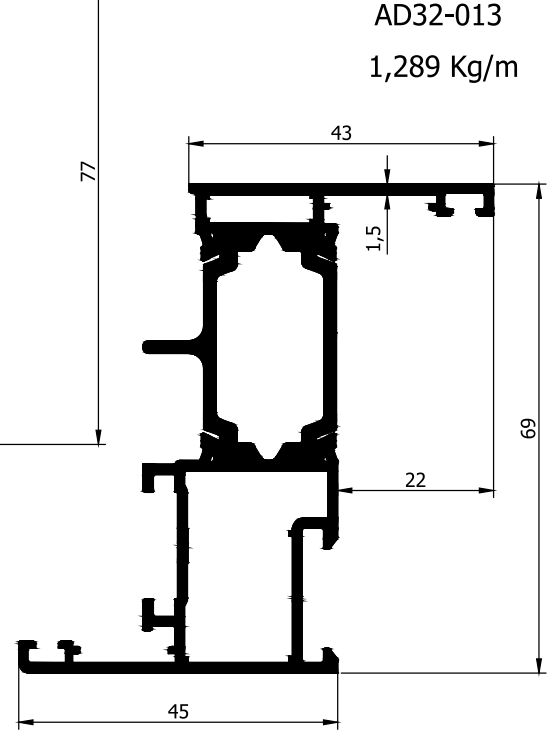

AD32-013
1,289 Kg/m

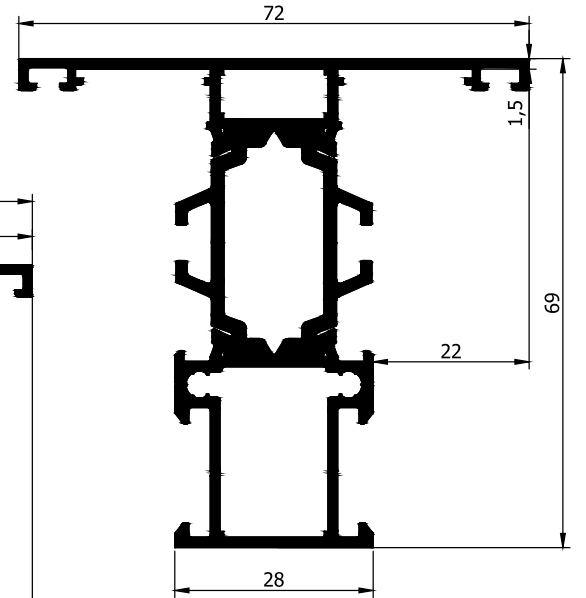
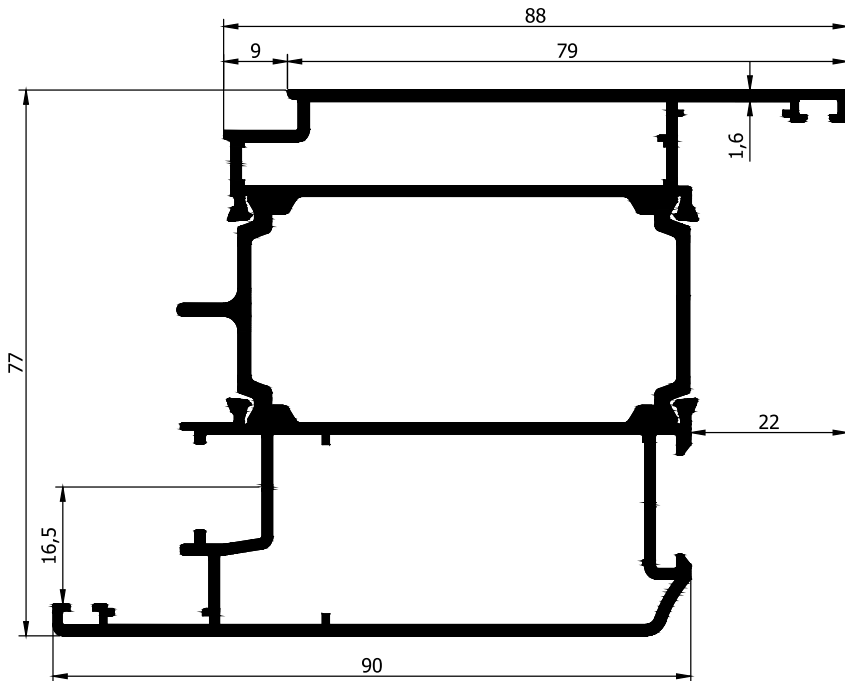

AD32-023
2,154 Kg/m

AD32-015
1,389 Kg/m

AD 69 T YALITIMLI DOĞRAMA PROFİLLERİ

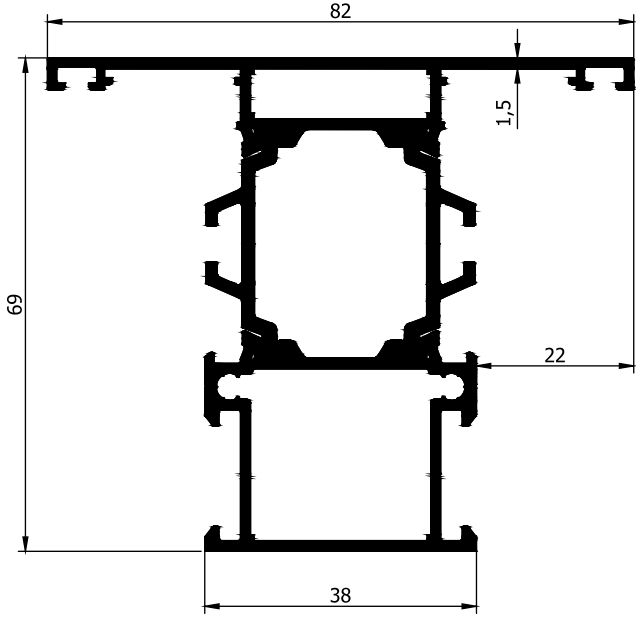

AD32-016
1,551 Kg/m

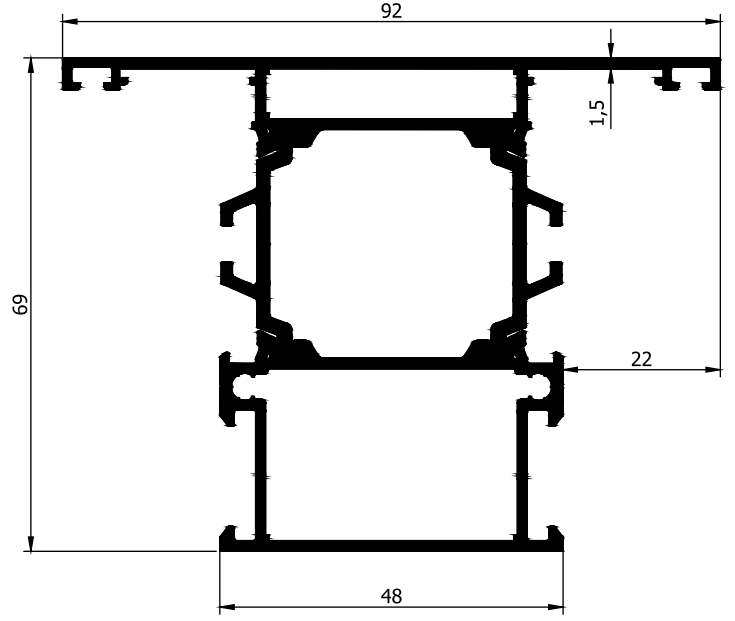

AD32-017
1,715 Kg/m

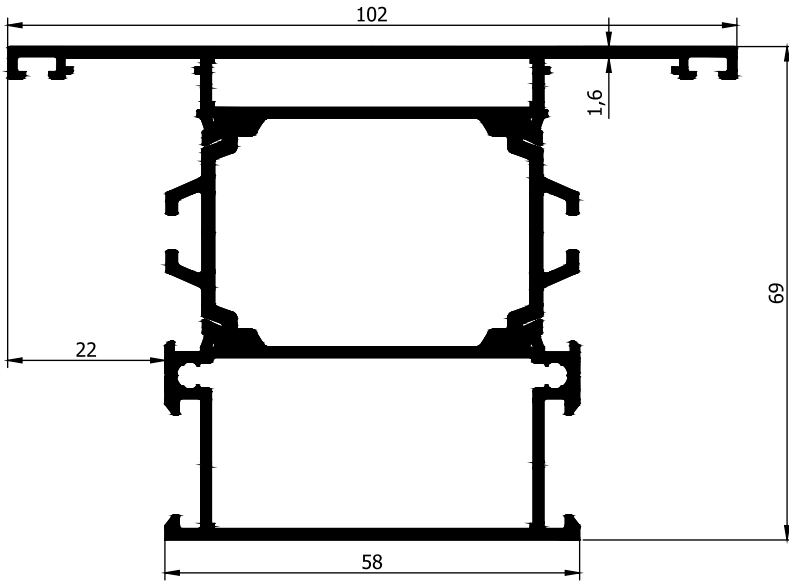

AD32-018
1,929 Kg/m

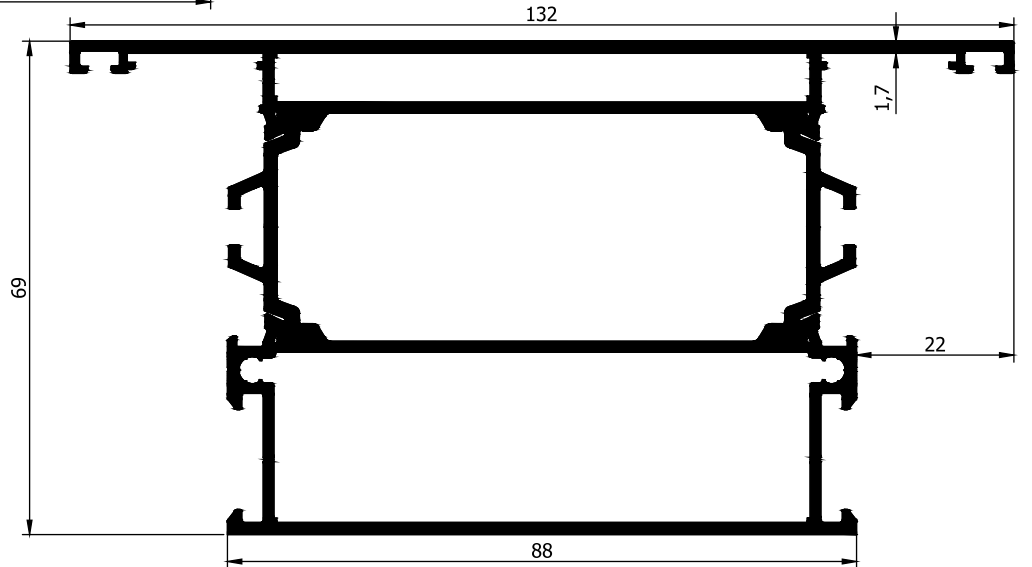

AD32-019
2,485 Kg/m

Uyarı: Profil ağırlıklarımız teorik olup; teslim anındaki tartımız geçerlidir.

AD 69 T YALITIMLI DOĞRAMA PROFİLLERİ

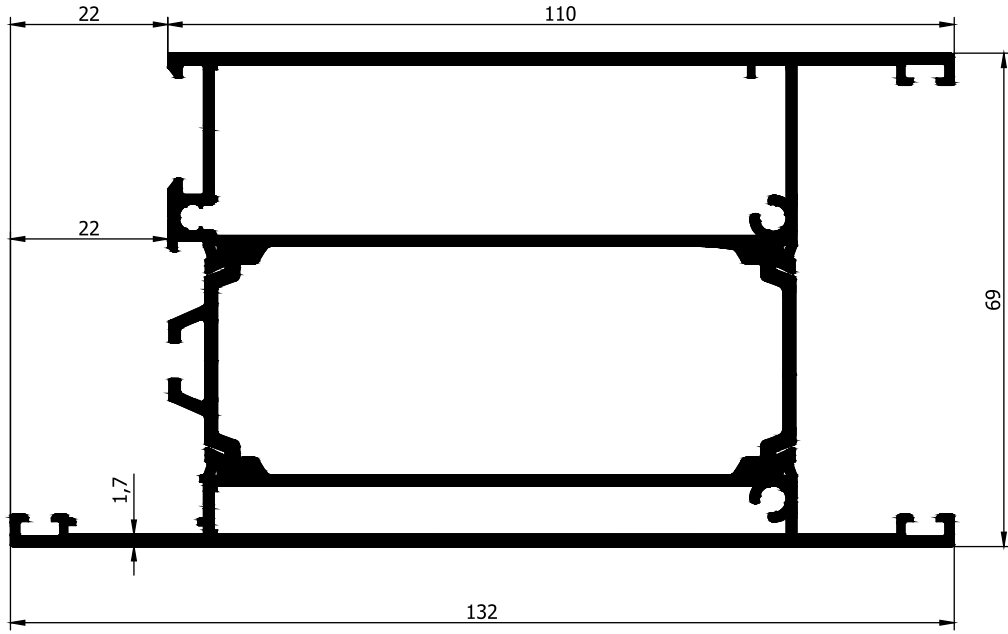

AD32-020
2,603 Kg/m

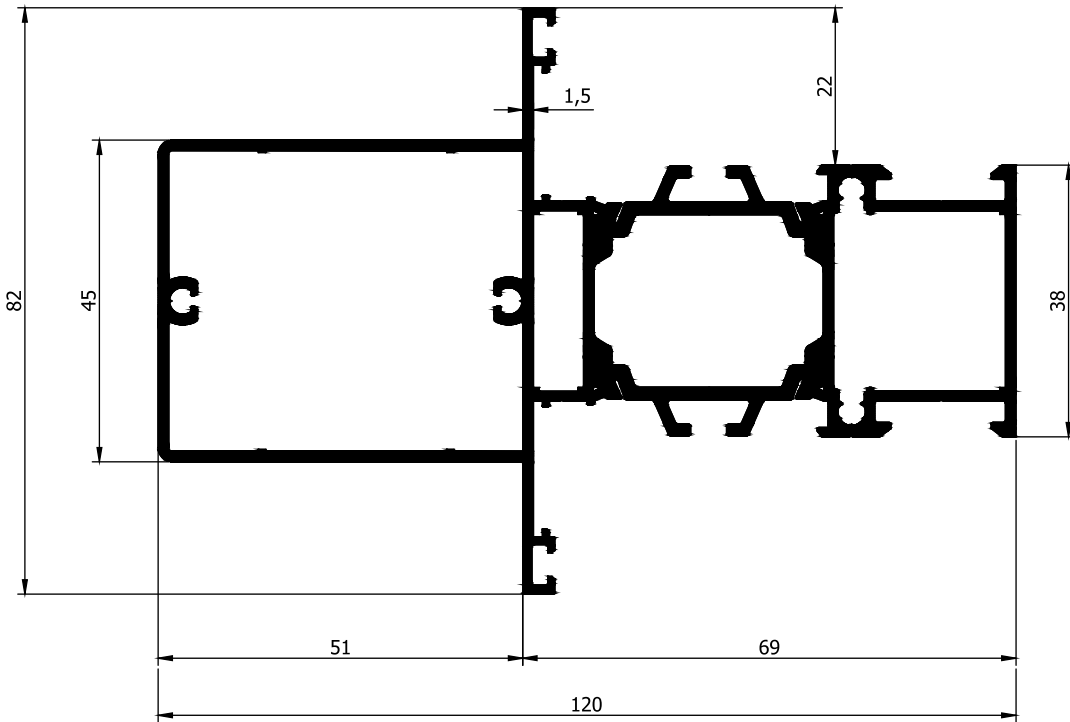

AD32-021
2,217 Kg/m

AD 69 T YALITIMLI DOĞRAMA PROFİLLERİ

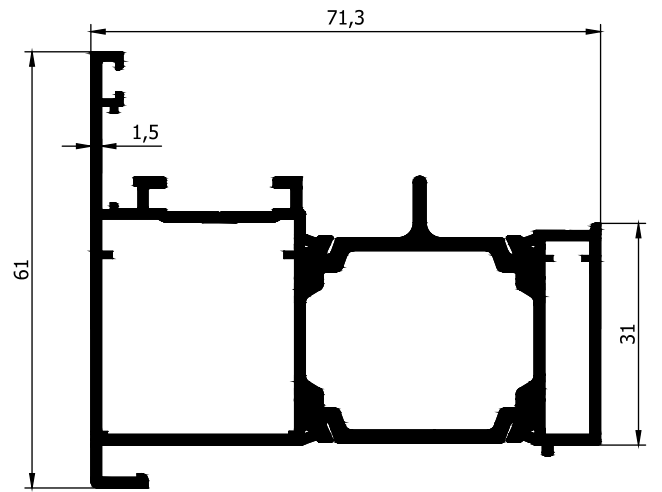
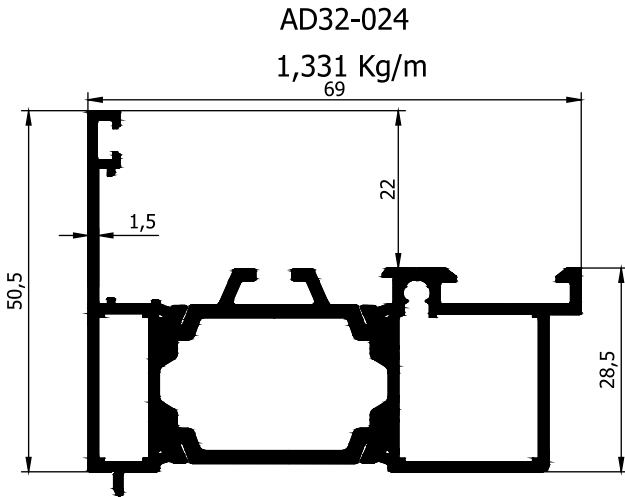
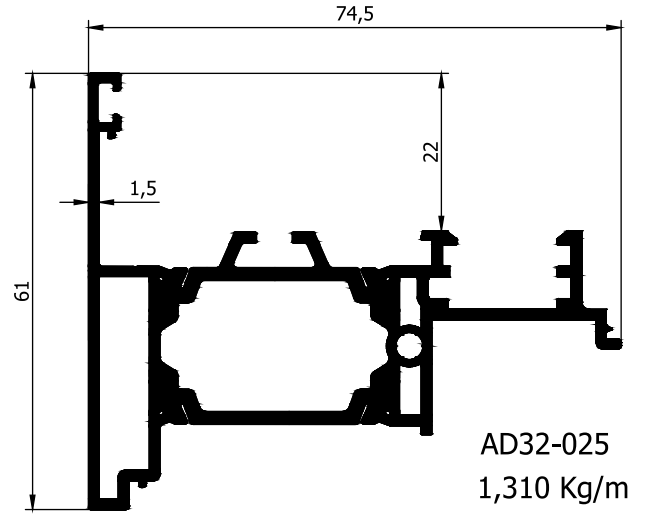
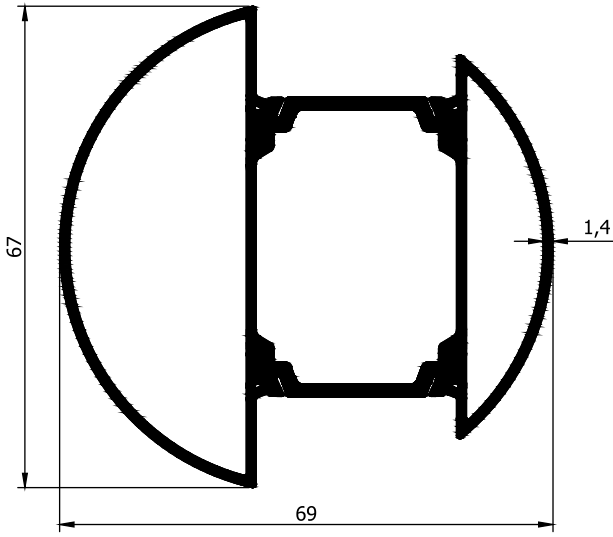
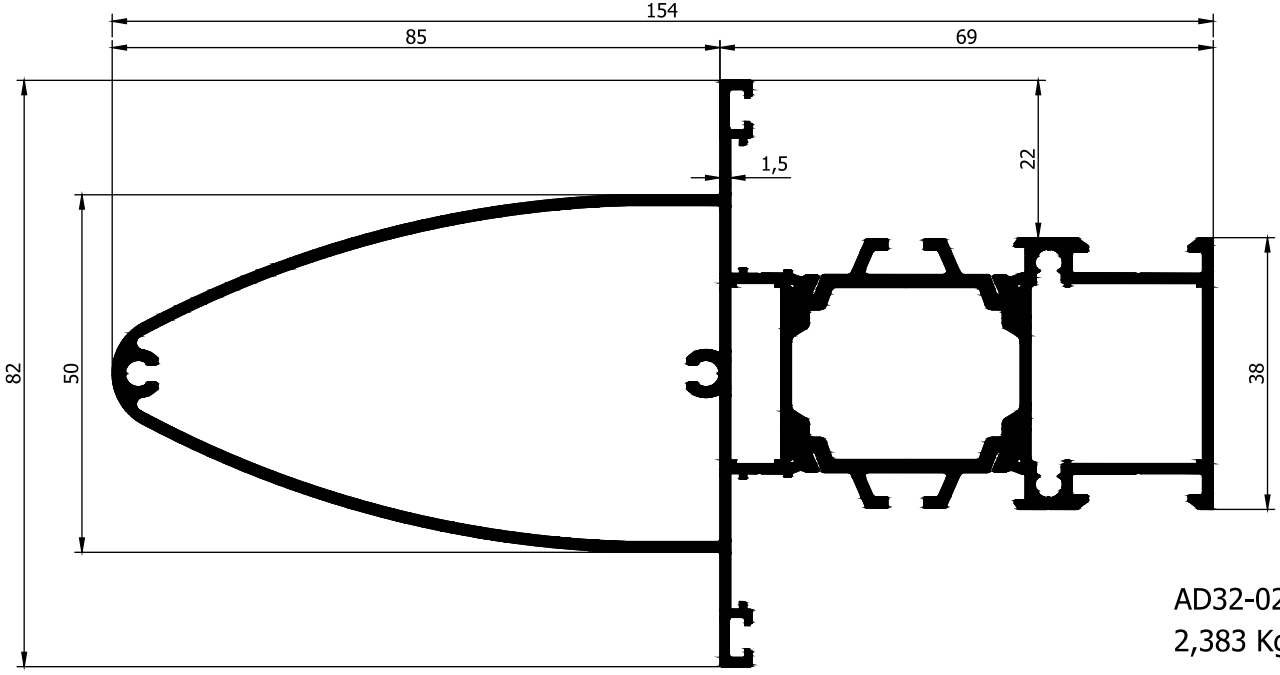

AD 69 T YALITIMLI DOĞRAMA PROFİLLERİ

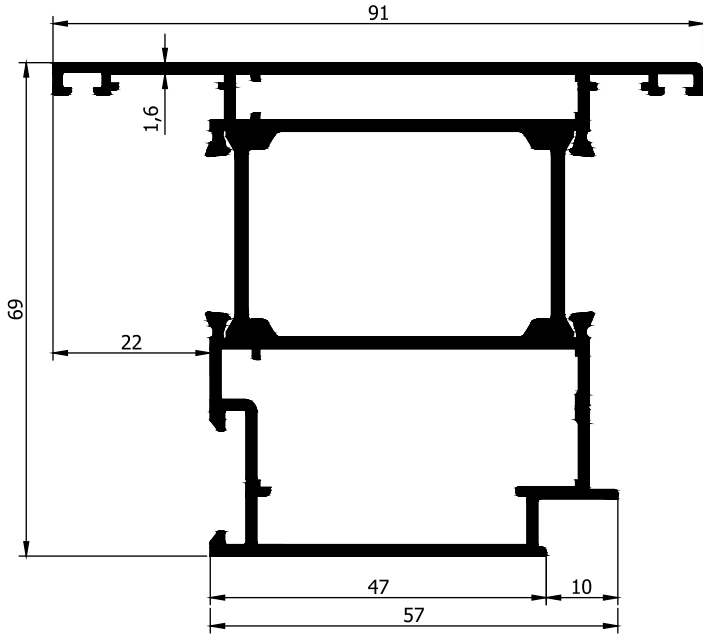

AD32-052
1,796 Kg/m

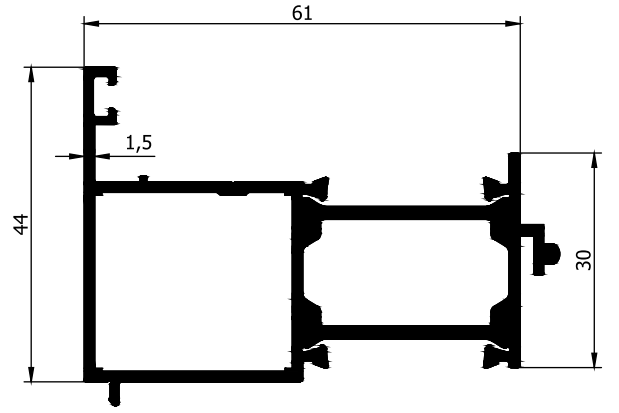

AD32-056
1,039 Kg/m

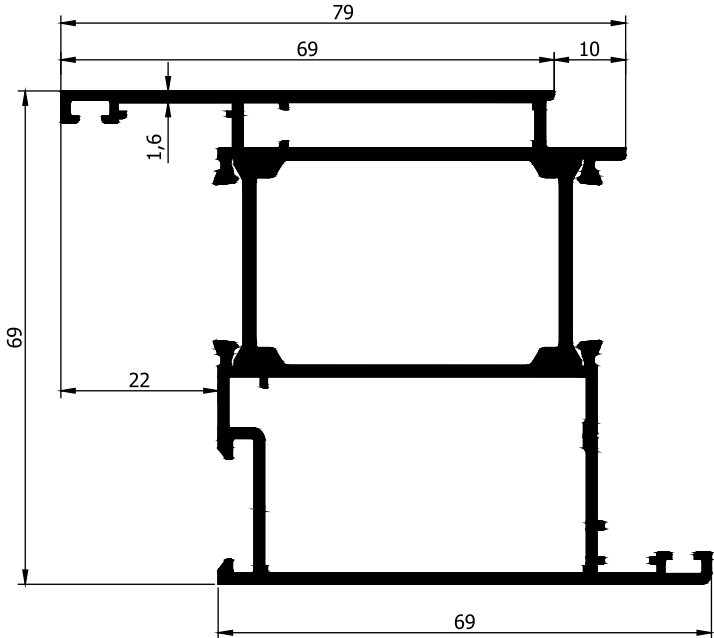

AD32-053
1,759 Kg/m

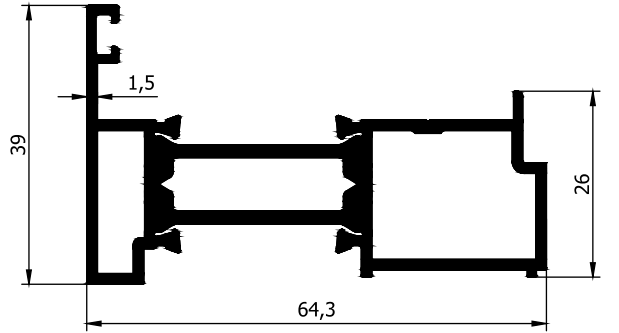

AD32-057
1,005 Kg/m

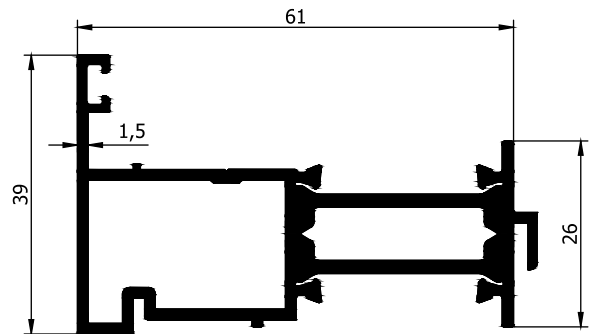

AD32-058
0,976 Kg/m

AD 69 T YALITIMLI DOĞRAMA PROFİLLERİ 2 mm

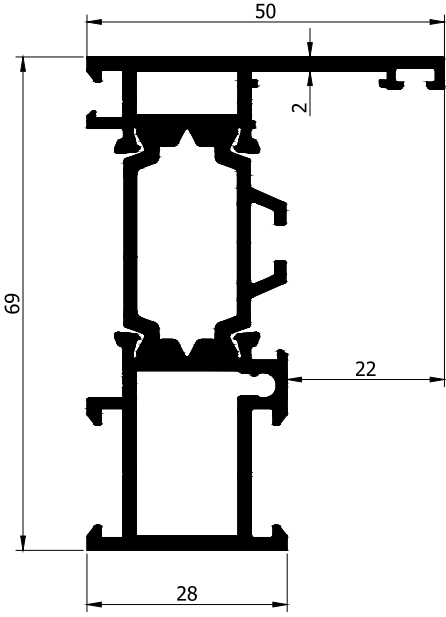

AD32-035
1,428 Kg/m

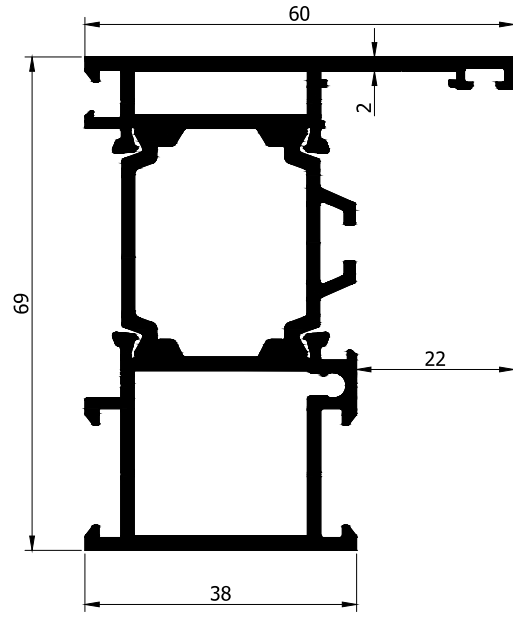

AD32-036
1,643 Kg/m

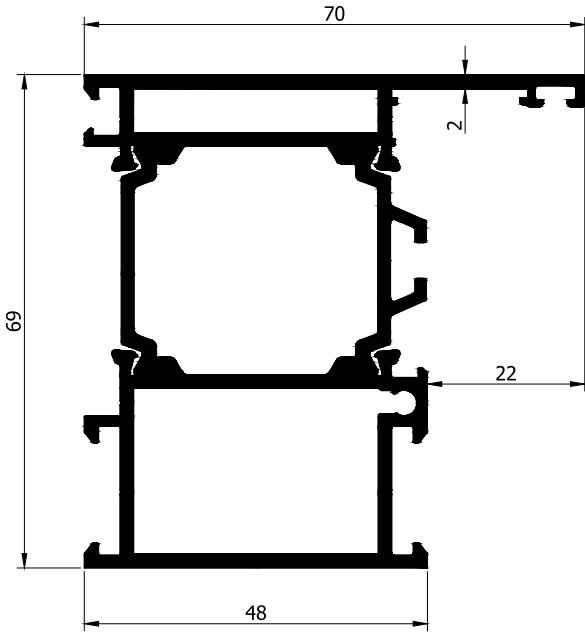

AD32-030
1,854 Kg/m

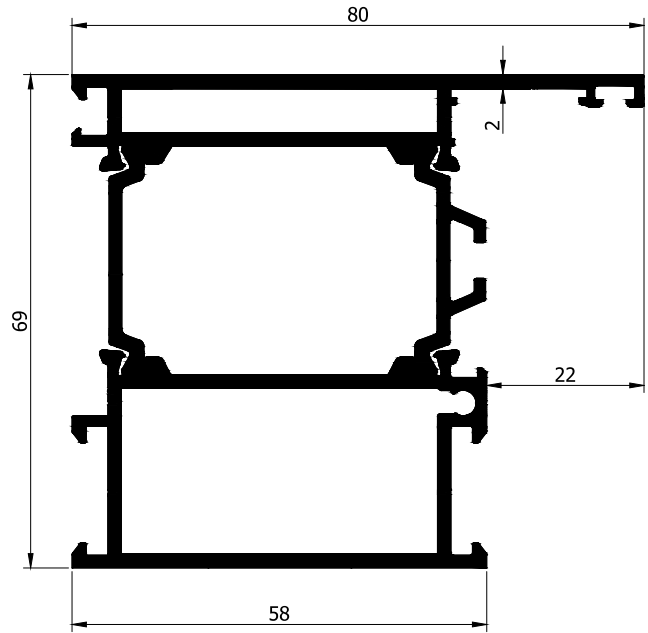

AD32-037
2,065 Kg/m

Uyarı: Profil ağırlıklarımız teorik olup; teslim anındaki tartımız geçerlidir.

AD 69 T YALITIMLI DOĞRAMA PROFİLLERİ 2 mm

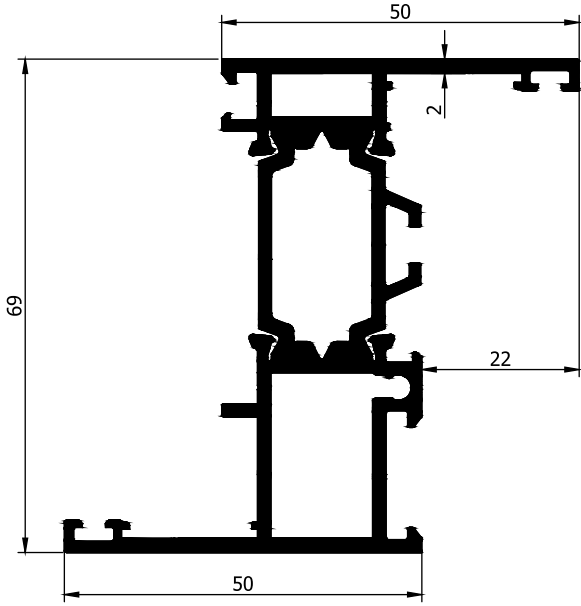

AD32-038
1,558 Kg/m

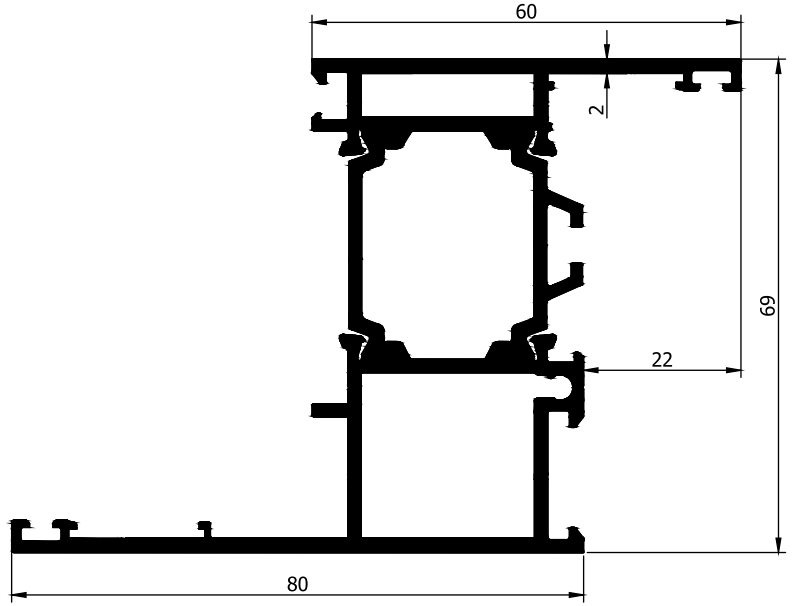

AD32-039
1,886 Kg/m

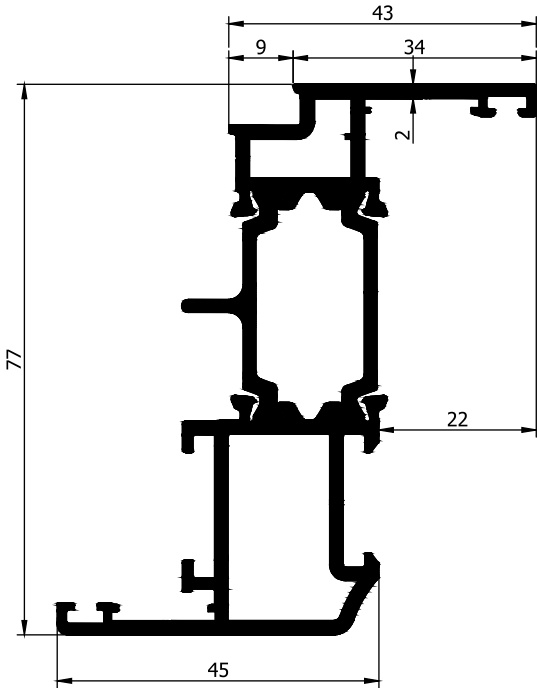

AD32-040
1,575 Kg/m

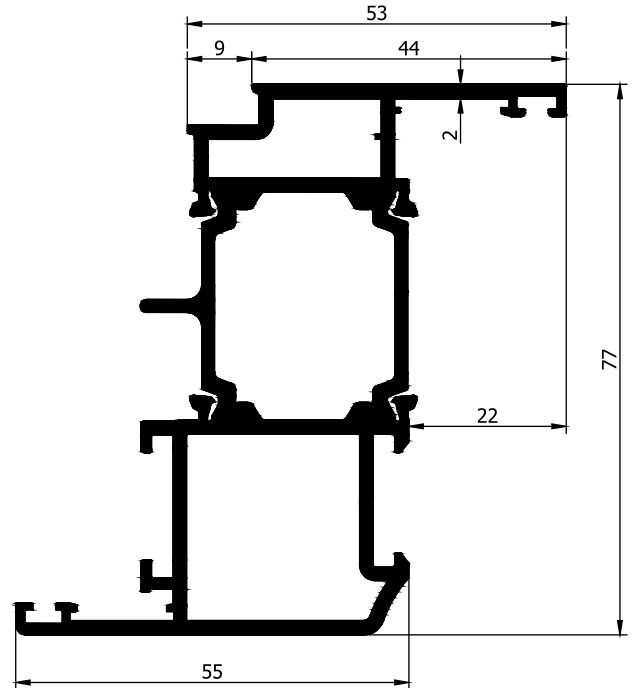

AD32-031
1,784 Kg/m

Uyarı: Profil ağırlıklarımız teorik olup; teslim anındaki tartımız geçerlidir.

AD 69 T YALITIMLI DOĞRAMA PROFİLLERİ 2 mm

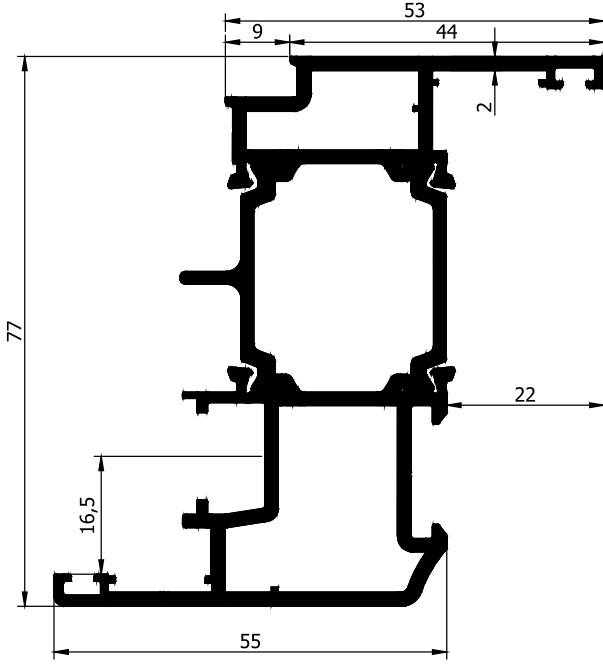

AD32-041
1,795 Kg/m

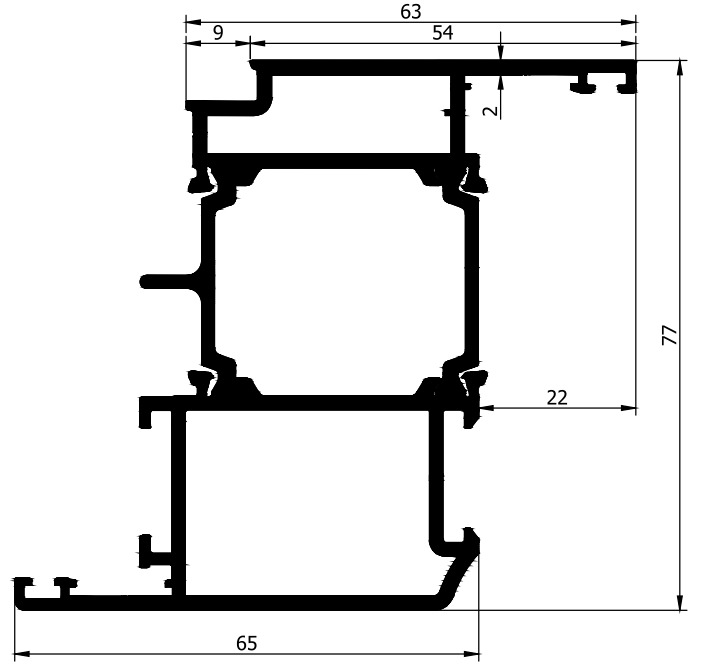

AD32-042
1,995 Kg/m

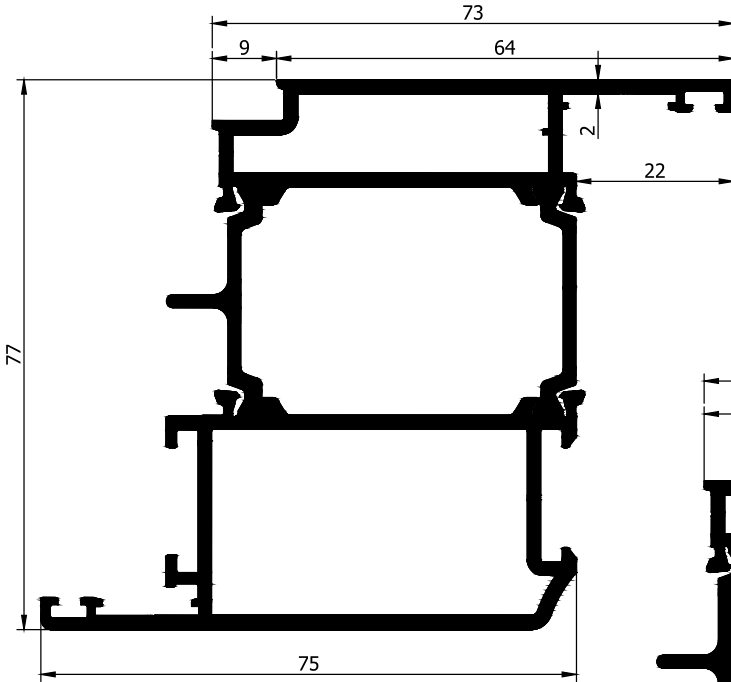

AD32-043
2,206 Kg/m

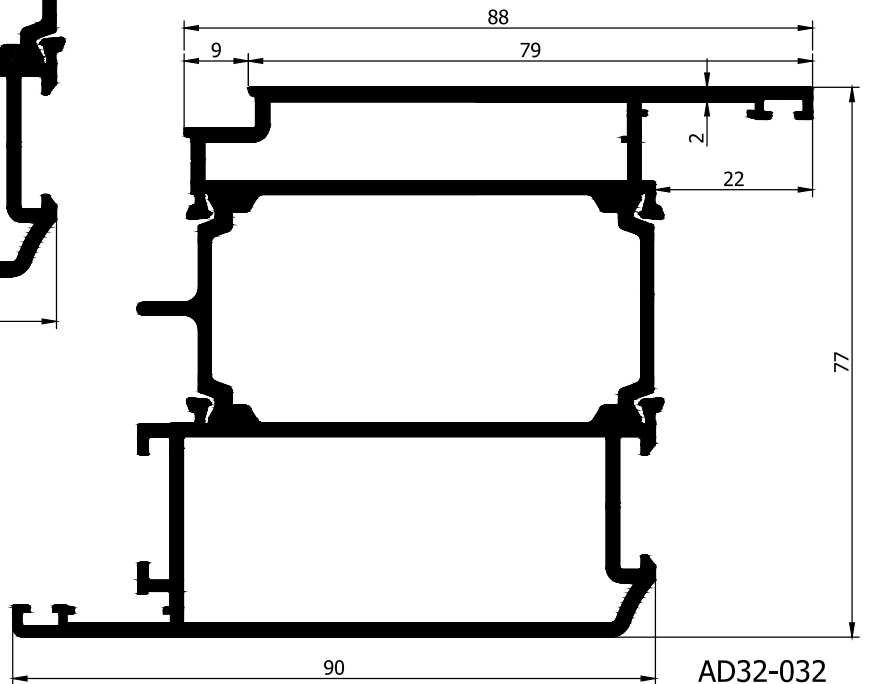

AD32-032
2,523 Kg/m

AD 69 T YALITIMLI DOĞRAMA PROFİLLERİ 2 mm

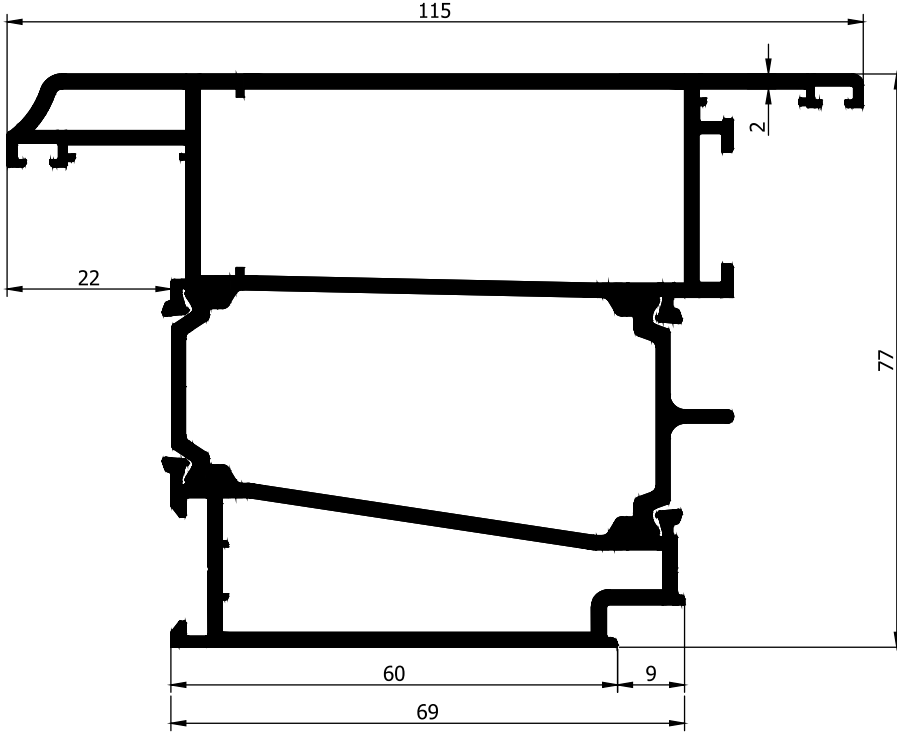

AD32-033
2,749 Kg/m

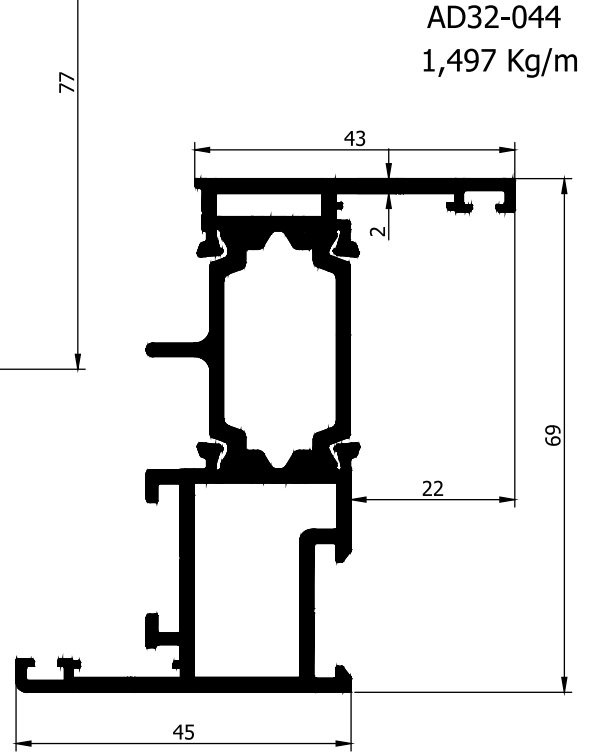

AD32-044
1,497 Kg/m

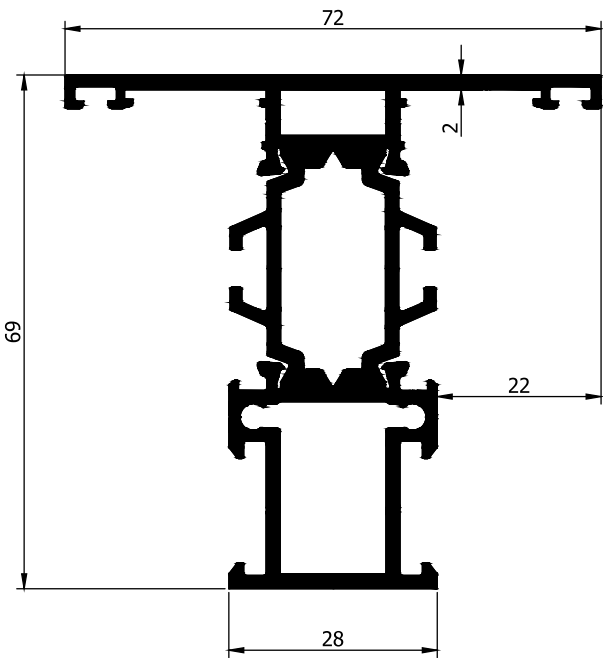

AD32-045
1,606 Kg/m

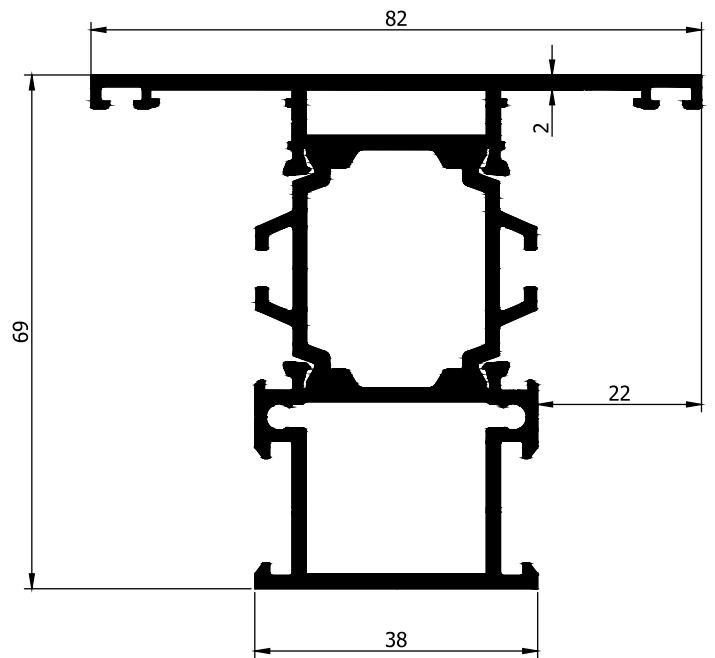

AD32-046
1,818 Kg/m

Uyarı: Profil ağırlıklarımız teorik olup; teslim anındaki tartımız geçerlidir.

AD 69 T YALITIMLI DOĞRAMA PROFİLLERİ 2 mm

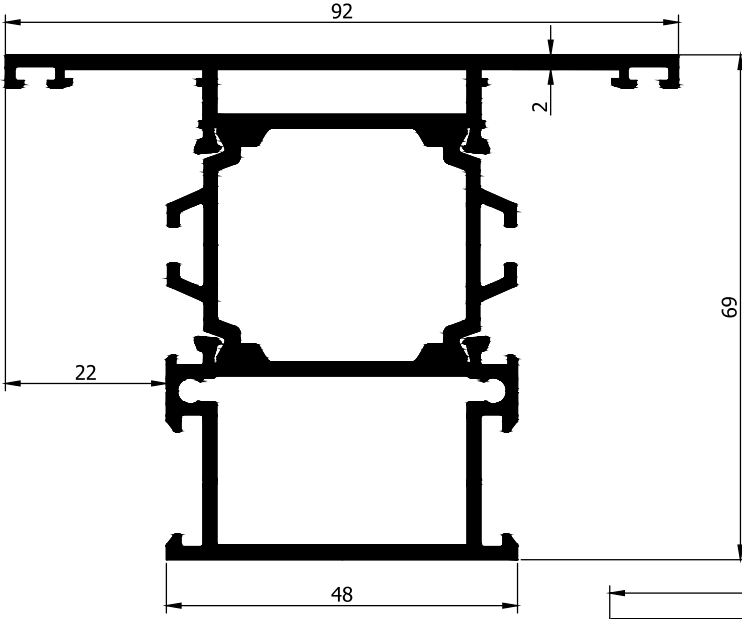

AD32-034
2,029 Kg/m

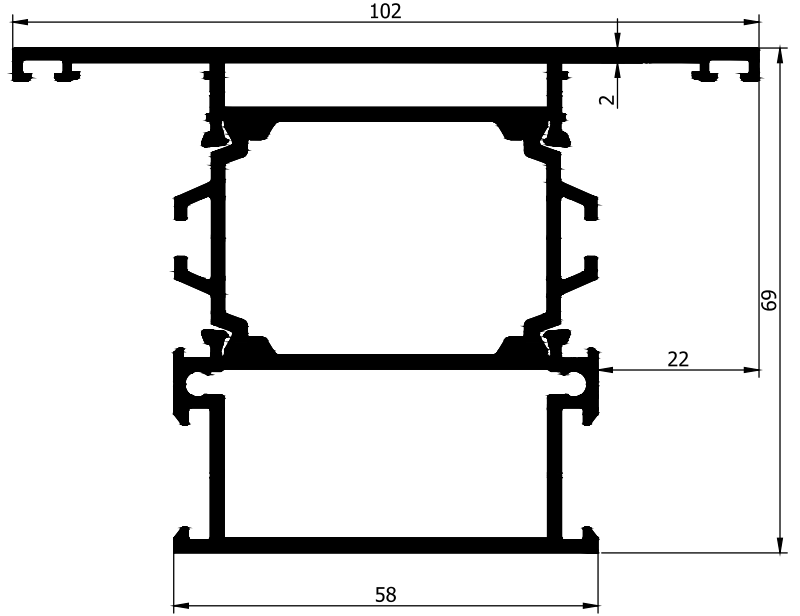

AD32-047
2,240 Kg/m

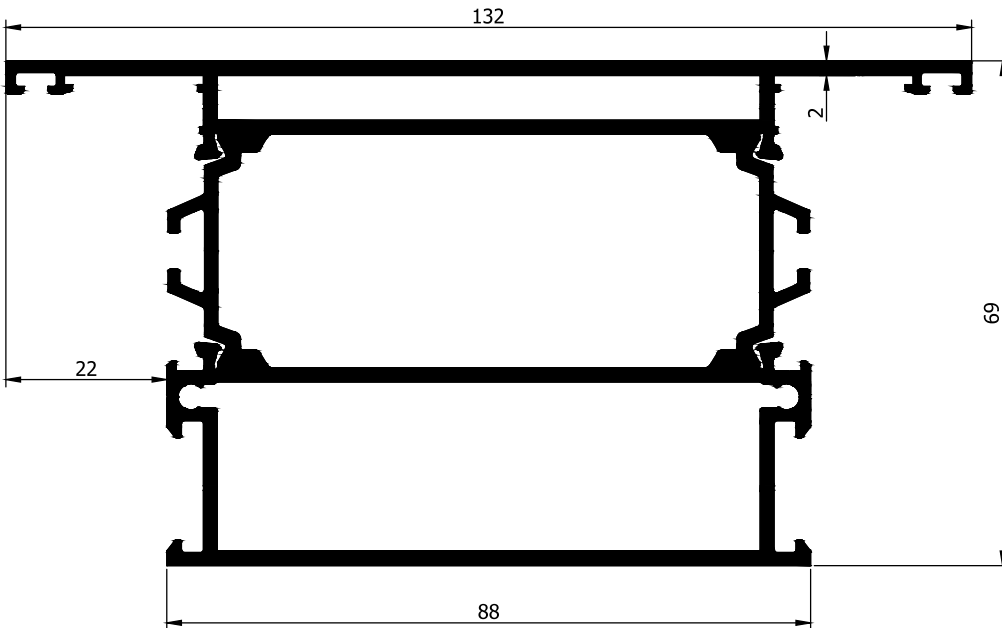

AD32-048
2,875 Kg/m

AD 69 T YALITIMLI DOĞRAMA PROFİLLERİ 2 mm

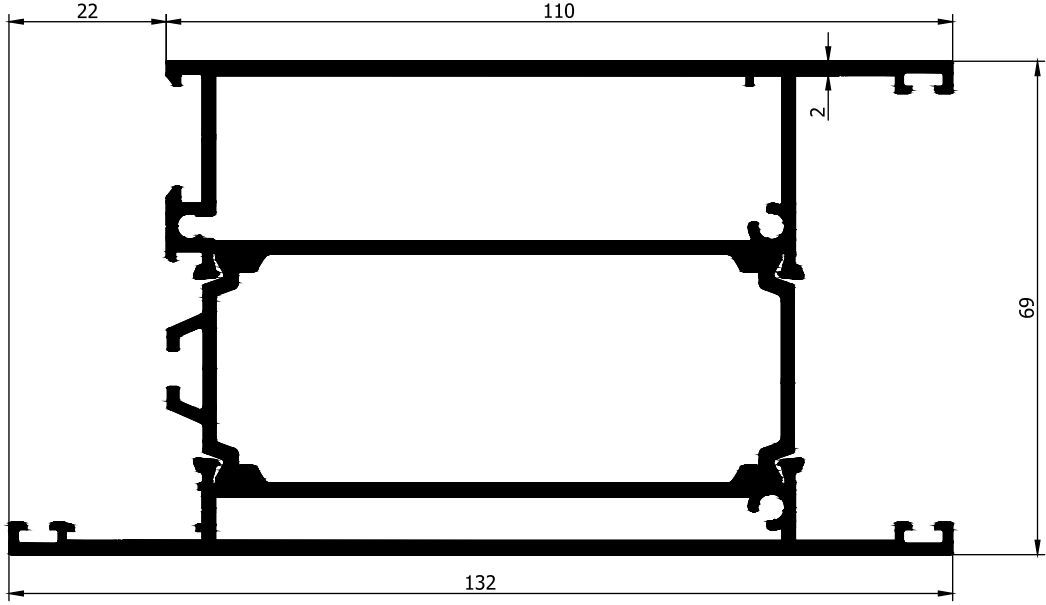

AD32-049
2,995 Kg/m

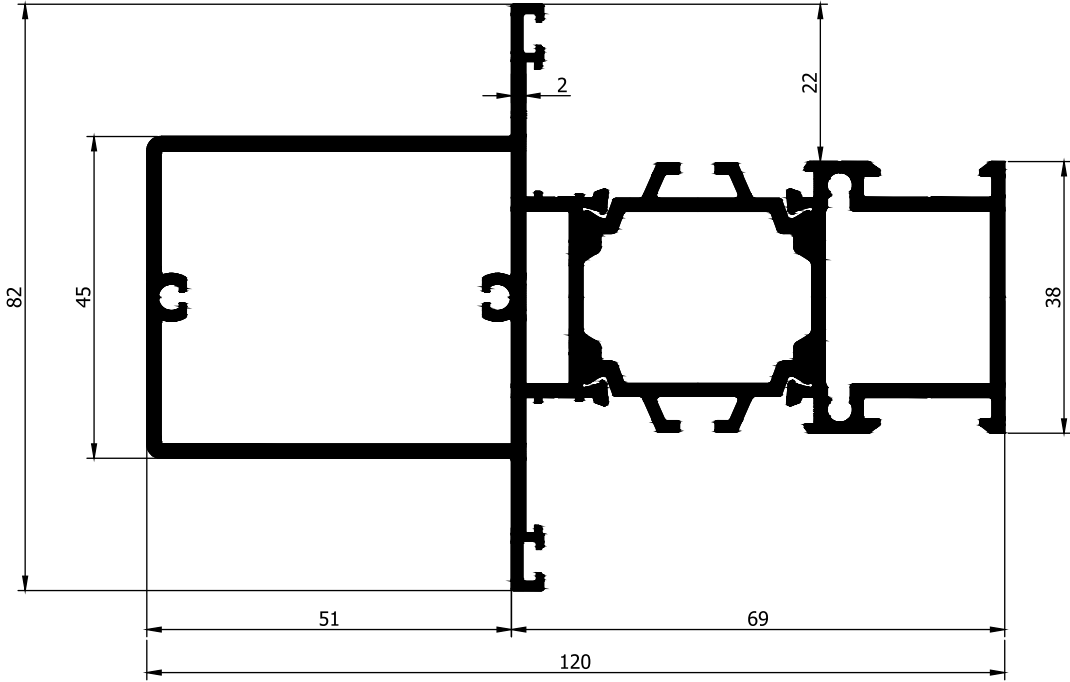

AD32-050
2,661 Kg/m

AD 69 T YALITIMLI DOĞRAMA PROFİLLERİ 2 mm

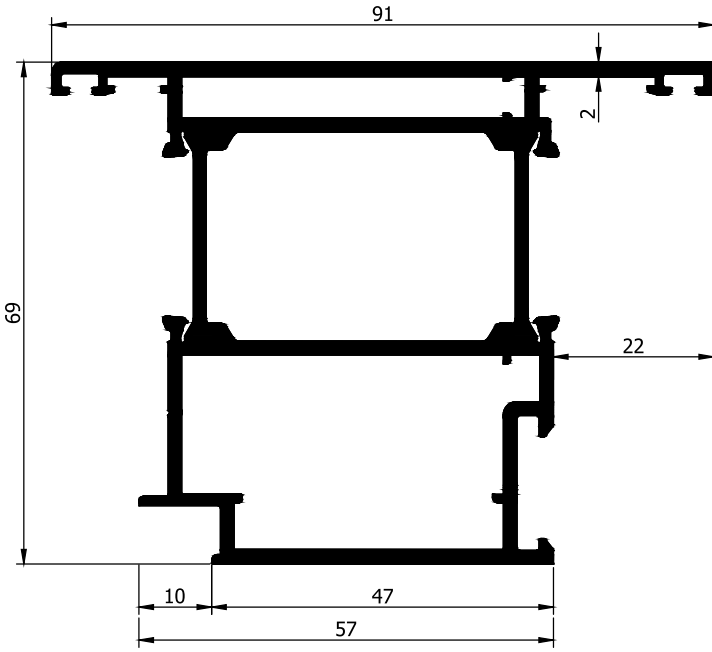
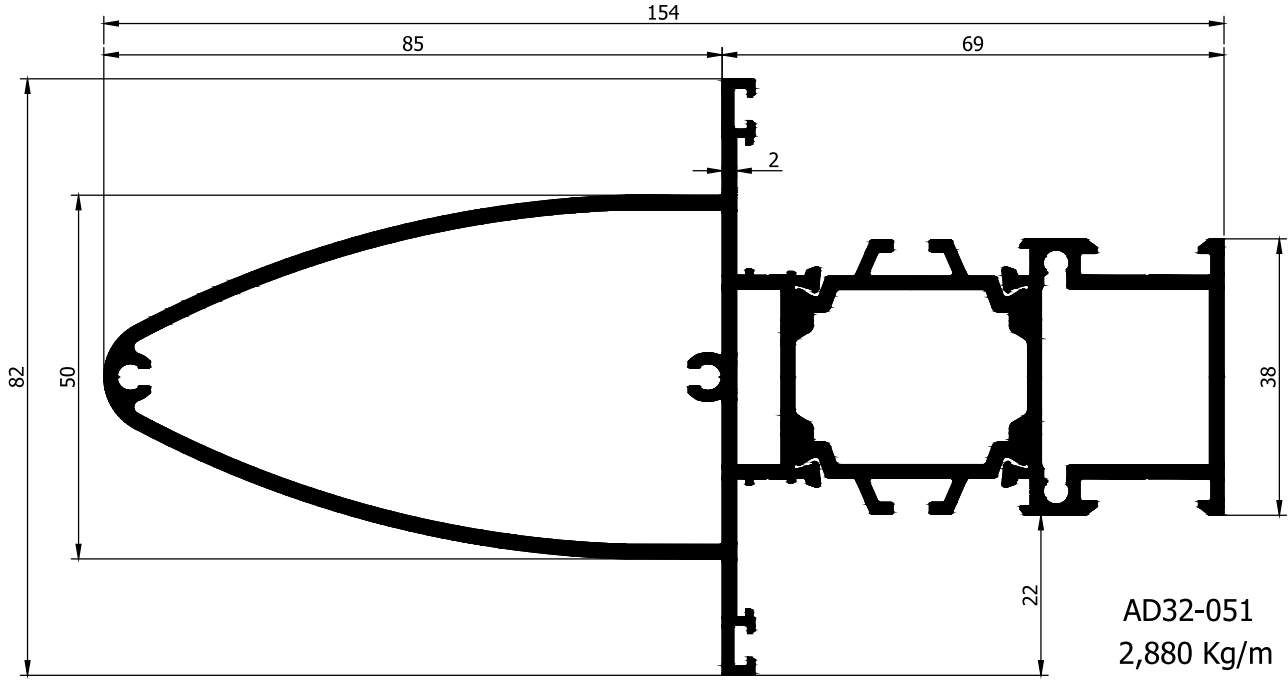

AD32-055
2,026 Kg/m

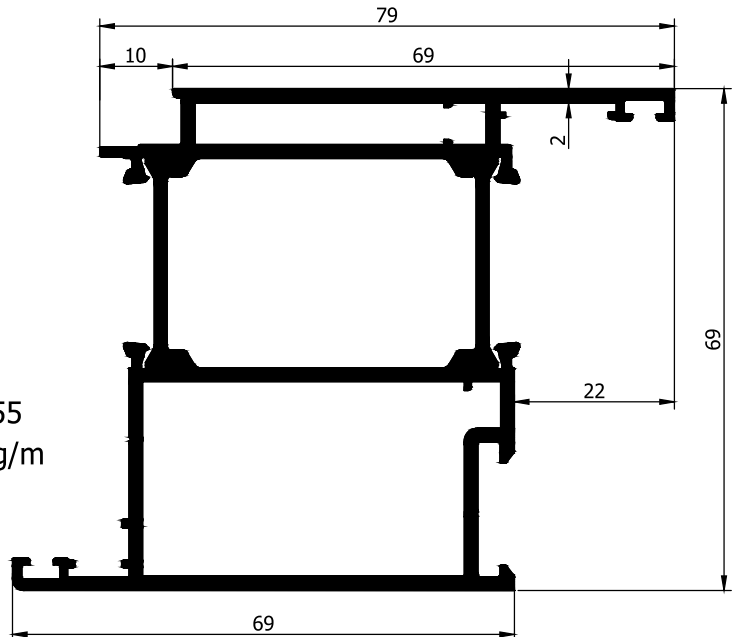

AD 69 T YALITIMLI DOĞRAMA PROFİLLERİ

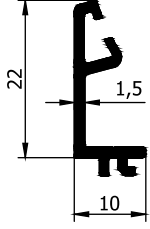

AD 21 - 040
0,179 Kg/m

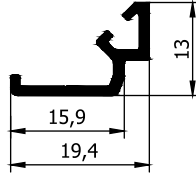

AD 21 - 041
0,140 Kg/m

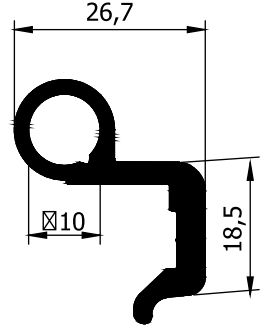

KASA MENTEŞE
AD 21 - 080
0,575 Kg/m

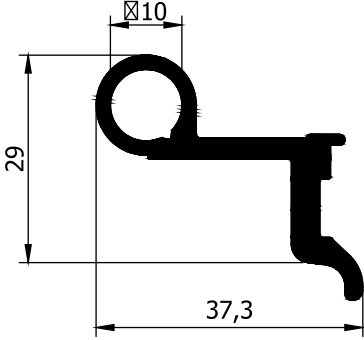

KANAT MENTEŞE
AD 21 - 081
0,640 Kg/m

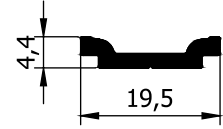

AD20-038
0,130 Kg/m

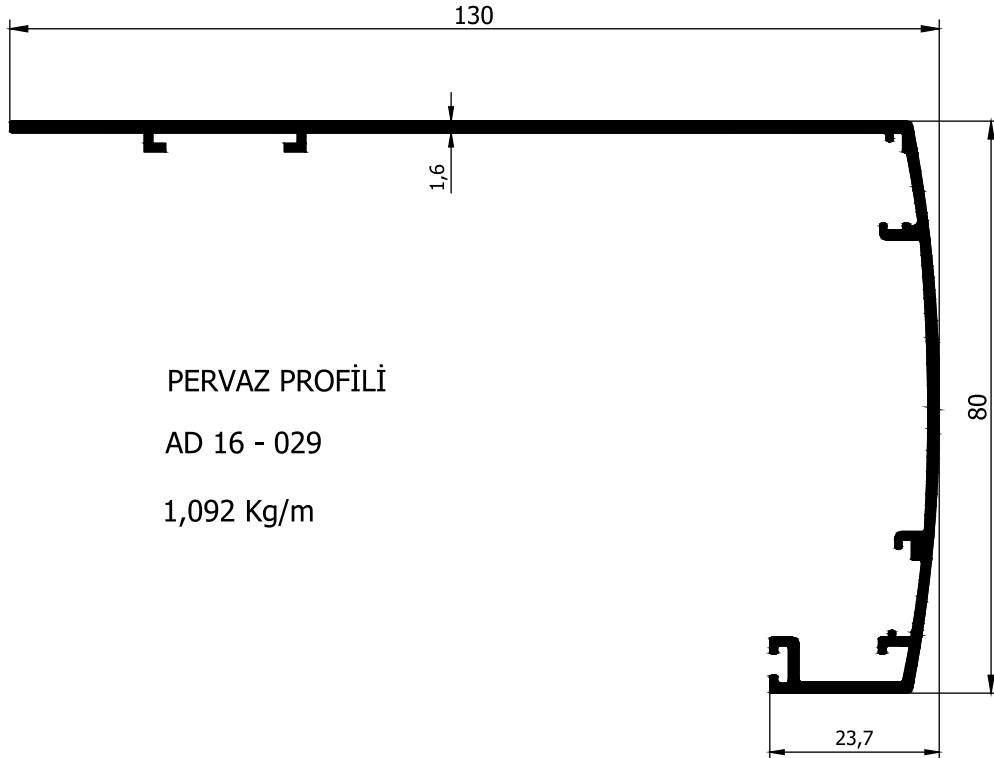

PERVAZ PROFİLİ
AD 16 - 029
1,092 Kg/m

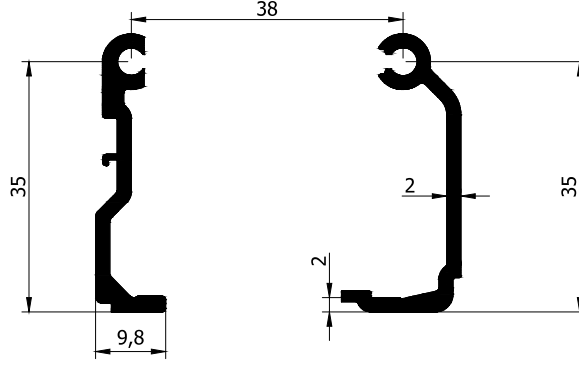
AD 69 T YALITIMLI DOĞRAMA PROFİLLERİ**ORTA KAYIT
BAĞLANTI PROFİLİ**

AD 21 - 042

0,327 Kg/m

**ORTA KAYIT
BAĞLANTI PROFİLİ**

AD 21 - 043

0,347 Kg/m

**AD 21 - 042 ve AD 21 - 043
KESİM ÖLÇÜLERİ**

| Kullanılan Prf. | Kesim Ölçüsü |
|-----------------|--------------|
| AD 32 - 015 | 13,7 MM |
| AD 32 - 016 | 23,7 MM |
| AD 32 - 017 | 33,7 MM |
| AD 32 - 018 | 43,7 MM |
| AD 32 - 019 | 73,7 MM |
| AD 32 - 020 | 73,7 MM |
| AD 32 - 021 | 23,7 MM |
| AD 32 - 022 | 23,7 MM |
| AD 32 - 045 | 13,7 MM |
| AD 32 - 046 | 23,7 MM |
| AD 32 - 034 | 33,7 MM |
| AD 32 - 047 | 43,7 MM |
| AD 32 - 048 | 73,7 MM |
| AD 32 - 049 | 73,7 MM |
| AD 32 - 050 | 23,7 MM |
| AD 32 - 051 | 23,7 MM |

Uyarı: Profil ağırlıklarımız teorik olup; teslim anındaki tartımız geçerlidir.

AD 69 T YALITIMLI DOĞRAMA PROFİLLERİ

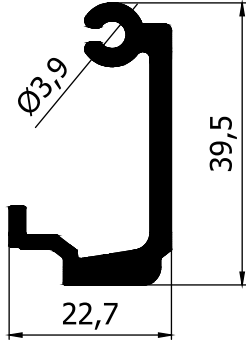

ORTA KAYIT BAĞLANTI PROFİLİ

AD 21 - 074

0,623 Kg/m

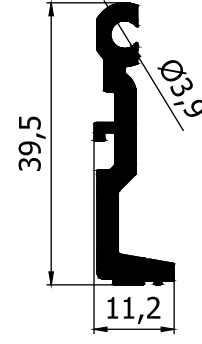

ORTA KAYIT BAĞLANTI PROFİLİ

AD 21 - 075

0,444 Kg/m

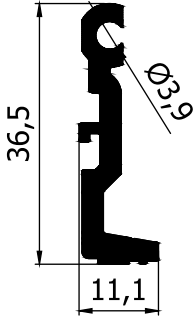

ORTA KAYIT BAĞLANTI PROFİLİ

AD 21 - 076

0,420 Kg/m

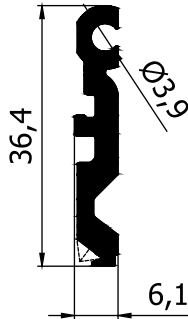

ORTA KAYIT BAĞLANTI PROFİLİ (SETSKURLU)

AD 21 - 077

0,388 Kg/m

AD21-074, AD21-075, AD21-076, AD21-077
PROFİLLERİNİN KESİM ÖLÇÜLERİ

| Kullanılan Prf. | Kesim Ölçüsü |
|-----------------|--------------|
| AD 32 - 015 | 13,7 MM |
| AD 32 - 016 | 23,7 MM |
| AD 32 - 017 | 33,7 MM |
| AD 32 - 018 | 43,7 MM |
| AD 32 - 019 | 73,7 MM |
| AD 32 - 020 | 73,7 MM |
| AD 32 - 021 | 23,7 MM |
| AD 32 - 022 | 23,7 MM |
| AD 32 - 045 | 13,7 MM |
| AD 32 - 046 | 23,7 MM |
| AD 32 - 034 | 33,7 MM |
| AD 32 - 047 | 43,7 MM |
| AD 32 - 048 | 73,7 MM |
| AD 32 - 049 | 73,7 MM |
| AD 32 - 050 | 23,7 MM |
| AD 32 - 051 | 23,7 MM |

AD 69 T YALITIMLI DOĞRAMA PROFİLLERİ

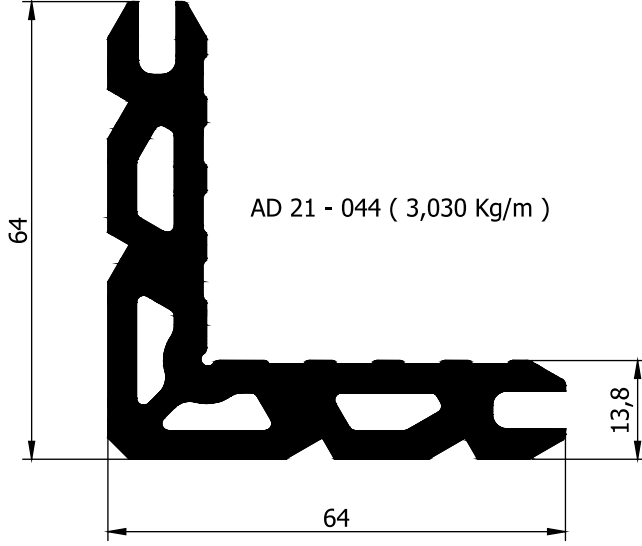

AD 21 - 044 (3,030 Kg/m)

| Kullanılan Prf. | Dış Bölüm Kesim Ölçüsü | İç Bölüm Kesim Ölçüsü |
|---|------------------------|-----------------------|
| AD 32 - 001 AD 32 - 005 AD 32 - 015 | 6,5 mm | 23,5 mm |
| AD 32 - 007 | 5,9 mm | 26,5 mm |
| AD 32 - 013 | 3,5 mm | 26,5 mm |
| AD 32 - 035 AD 32 - 038 AD 32 - 045 | 5,7 mm | 22,7 mm |
| AD 32 - 040 | 5 mm | 25,7 mm |
| AD 32 - 044 | 2,7 mm | 25,7 mm |

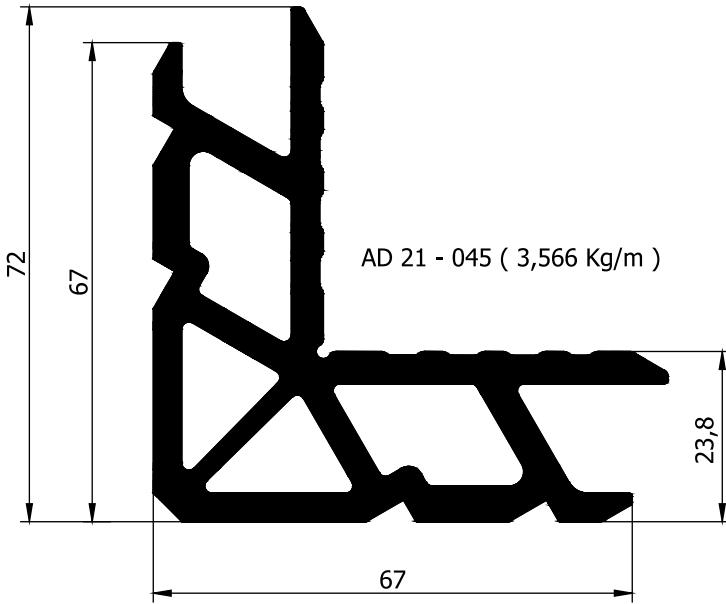

AD 21 - 045 (3,566 Kg/m)

| Kullanılan Prf. | Dış Bölüm Kesim Ölçüsü | İç Bölüm Kesim Ölçüsü |
|---|------------------------|-----------------------|
| AD 32 - 002 AD 32 - 006 AD 32 - 016 AD 32 - 021 AD 32 - 022 | 6,5 mm | 23,5 mm |
| AD 32 - 008 AD 32 - 009 | 5,8 mm 5,9 mm | 26,5 mm Farklı |
| AD 32 - 027 | | 26,5 mm |
| AD 32 - 056 | | 27 mm |
| AD 32 - 036 AD 32 - 039 AD 32 - 046 AD 32 - 050 AD 32 - 051 | 5,7 mm | 22,7 mm |
| AD 32 - 031 AD 32 - 041 | 5 mm | 25,7 mm FARKLI |

Uyarı: Profil ağırlıklarımız teorik olup; teslim anındaki tartımız geçerlidir.

AD 69 T YALITIMLI DOĞRAMA PROFİLLERİ

AD 21 - 046 (4,157 Kg/m)

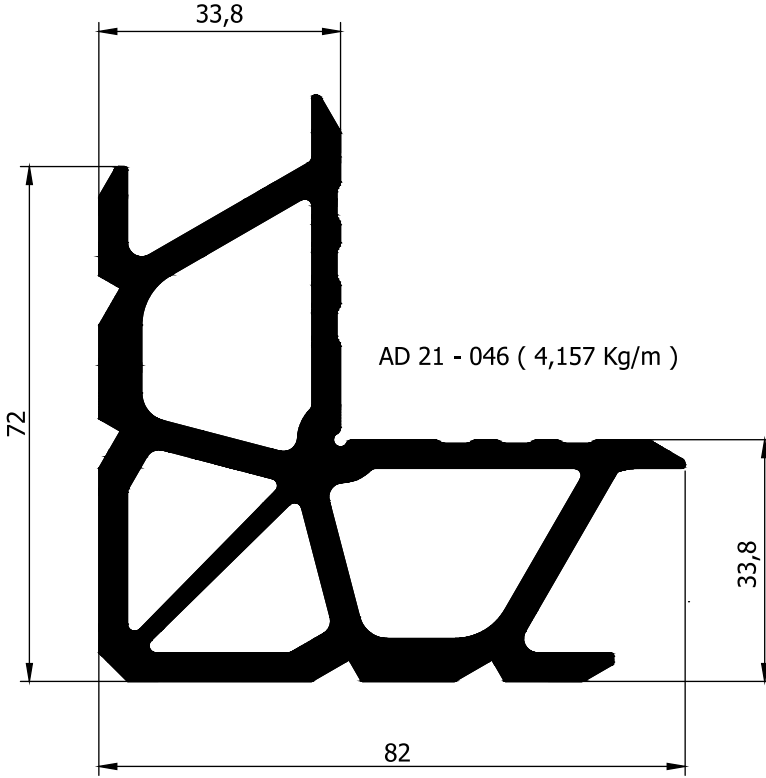

| Kullanılan Prf. | Dış Bölüm Kesim Ölçüsü | İç Bölüm Kesim Ölçüsü |
|----------------------------|------------------------|-----------------------|
| AD 32 - 003 AD 32 - 017 | 6,5 mm | 23,5 mm |
| AD 32 - 010 | 5,8 mm | 26,5 mm |
| AD 32 - 030 AD 32 - 034 | 5,7 mm | 22,7 mm |
| AD 32 - 042 | 5 mm | 25,7 mm |
| AD 32 - 055 | 5,3 mm | FARKLI |

AD 21 - 047 (3,220 Kg/m)

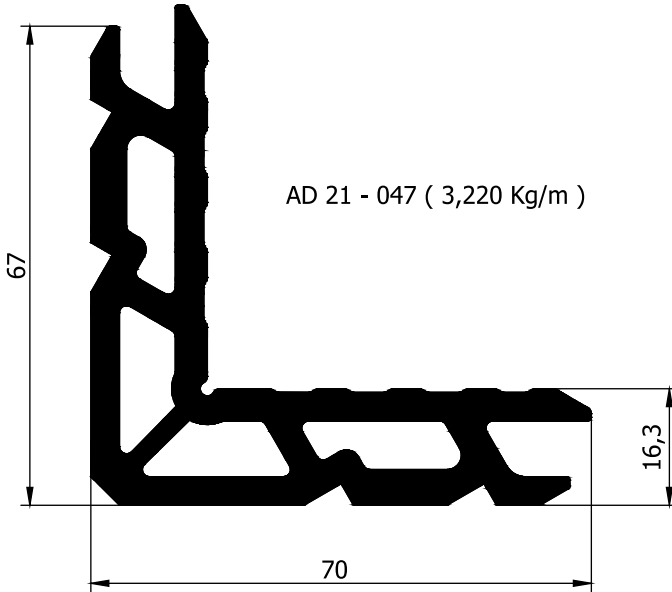

| Kullanılan Prf. | Kesim Ölçüsü |
|-----------------|--------------|
| AD 32 - 009 | 26.5 mm |
| AD 32 - 041 | 25,7 mm |

Uyarı: Profil ağırlıklarımız teorik olup; teslim anındaki tartımız geçerlidir.

AD 69 T YALITIMLI DOĞRAMA PROFİLLERİ

AD 21 - 048 (5,307 Kg/m)

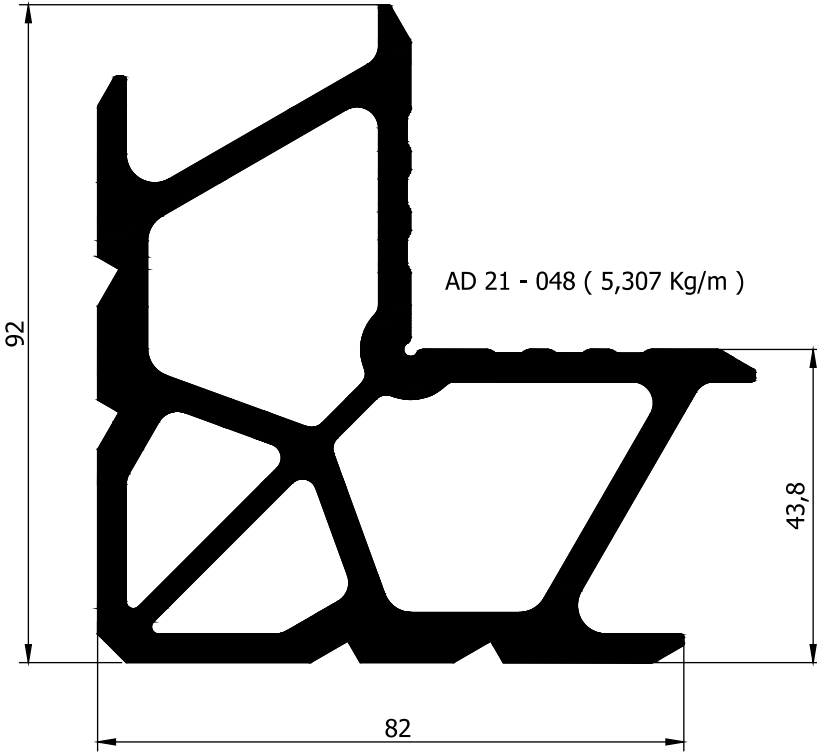

| Kullanılan Prf. | Dış Bölüm Kesim Ölçüsü | İç Bölüm Kesim Ölçüsü |
|----------------------------|------------------------|-----------------------|
| AD 32 - 004 AD 32 - 018 | 6,5 mm | 23,5 mm |
| AD 32 - 052 | 6 mm | 19 mm |
| AD 32 - 053 | 6 mm | 27 mm |
| AD 32 - 011 | 5,8 mm | 26,5 mm |
| AD 32 - 037 AD 32 - 047 | 5,7 mm | 22,7 mm |
| AD 32 - 043 | 5 mm | 25,7 mm |
| AD 32 - 023 | FARKLI | 26,5 mm |
| AD 32 - 054 | 5,3 mm | 18,7 mm |
| AD 32 - 055 | FARKLI | 26,3 mm |

AD 21 - 050 (6,366 Kg/m)

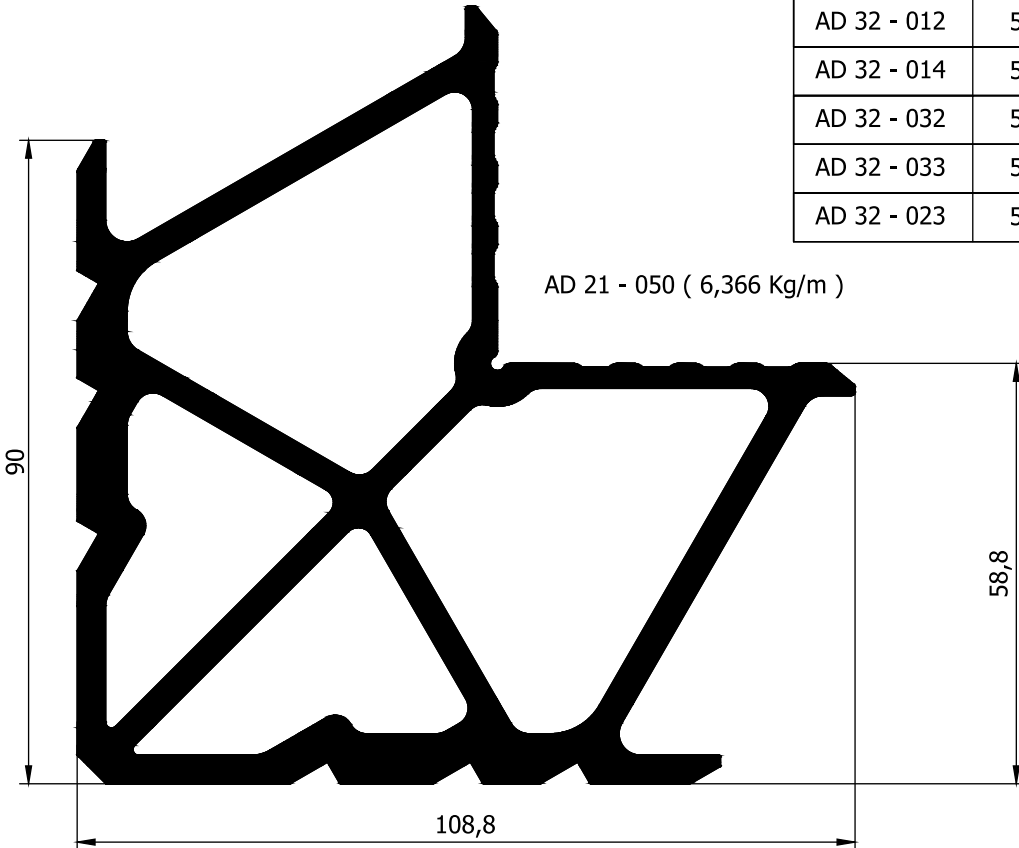

| Kullanılan Prf. | Dış Bölüm Kesim Ölçüsü | İç Bölüm Kesim Ölçüsü |
|-----------------|------------------------|-----------------------|
| AD 32 - 012 | 5,8 mm | 26,5 mm |
| AD 32 - 014 | 5,8 mm | 25,5 mm |
| AD 32 - 032 | 5 mm | 25,7 mm |
| AD 32 - 033 | 5 mm | 24,7 mm |
| AD 32 - 023 | 5,8 mm | FARKLI |

AD 69 T YALITIMLI DOĞRAMA PROFİLLERİ

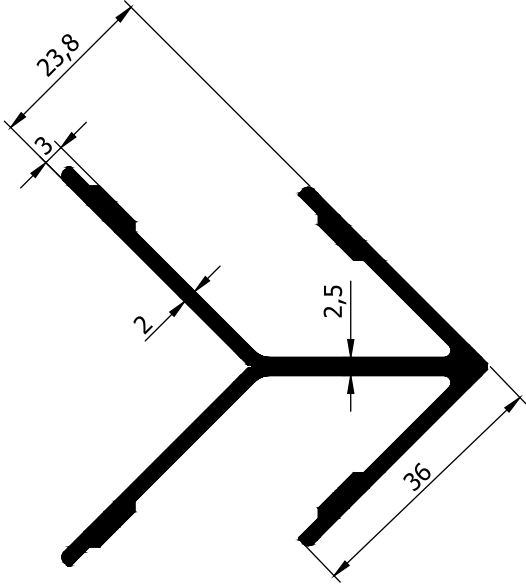

AD 20 - 048 (1,079 Kg/m)

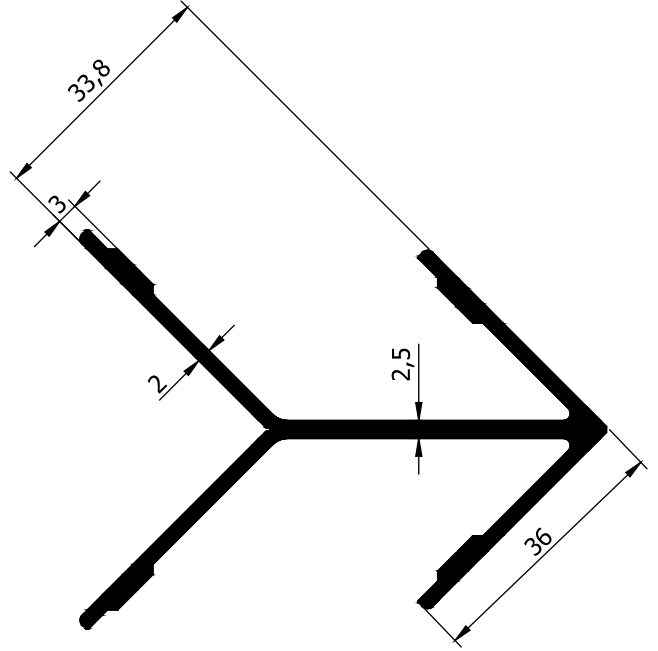

AD 20 - 049 (1,176 Kg/m)

| Kullanılan Prf. | Dış Bölüm Kesim Ölçüsü | İç Bölüm Kesim Ölçüsü |
|---|------------------------|-----------------------|
| AD 32 - 002 AD 32 - 006 AD 32 - 016 AD 32 - 021 AD 32 - 022 | 6,5 mm | 23,5 mm |
| AD 32 - 008 AD 32 - 009 | 5,8 mm 5,9 mm | 26,5 mm Farklı |
| AD 32 - 027 | | 26,5 mm |
| AD 32 - 056 | | 27 mm |
| AD 32 - 036 AD 32 - 039 AD 32 - 046 AD 32 - 050 AD 32 - 051 | 5,7 mm | 22,7 mm |
| AD 32 - 031 AD 32 - 041 | 5 mm | 25,7 mm FARKLI |

| Kullanılan Prf. | Dış Bölüm Kesim Ölçüsü | İç Bölüm Kesim Ölçüsü |
|----------------------------|------------------------|-----------------------|
| AD 32 - 003 AD 32 - 017 | 6,5 mm | 23,5 mm |
| AD 32 - 010 | 5,8 mm | 26,5 mm |
| AD 32 - 030 AD 32 - 034 | 5,7 mm | 22,7 mm |
| AD 32 - 042 | 5 mm | 25,7 mm |
| AD 32 - 055 | 5,3 mm | FARKLI |

AD 69 T YALITIMLI DOĞRAMA PROFİLLERİ

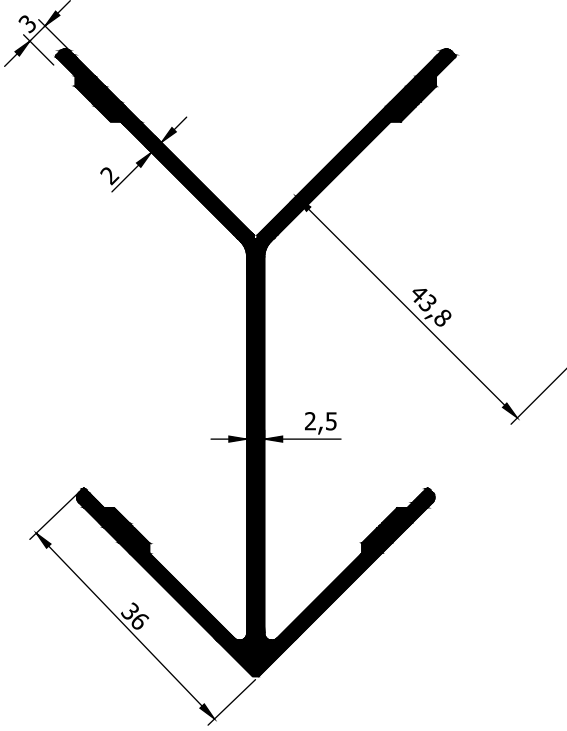

AD 20 - 050 (1,271 Kg/m)

| Kullanılan Prf. | Dış Bölüm Kesim Ölçüsü | İç Bölüm Kesim Ölçüsü |
|----------------------------|------------------------|-----------------------|
| AD 32 - 004 AD 32 - 018 | 6,5 mm | 23,5 mm |
| AD 32 - 052 | 6 mm | 19 mm |
| AD 32 - 053 | 6 mm | 27 mm |
| AD 32 - 011 | 5,8 mm | 26,5 mm |
| AD 32 - 037 AD 32 - 047 | 5,7 mm | 22,7 mm |
| AD 32 - 043 | 5 mm | 25,7 mm |
| AD 32 - 023 | FARKLI | 26,5 mm |
| AD 32 - 054 | 5,3 mm | 18,7 mm |
| AD 32 - 055 | FARKLI | 26,3 mm |

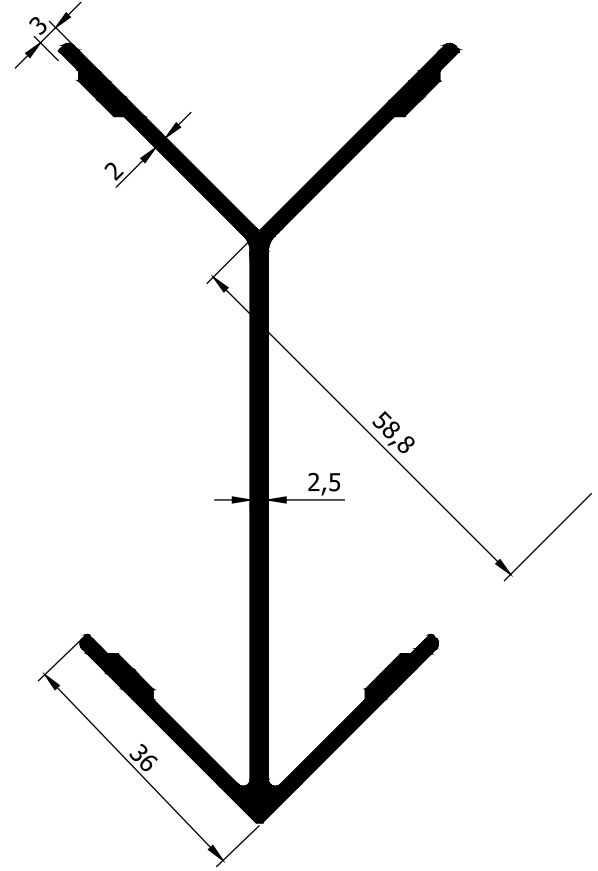

AD 20 - 051 (1,415 Kg/m)

| Kullanılan Prf. | Dış Bölüm Kesim Ölçüsü | İç Bölüm Kesim Ölçüsü |
|-----------------|------------------------|-----------------------|
| AD 32 - 012 | 5,8 mm | 26,5 mm |
| AD 32 - 014 | 5,8 mm | 25,5 mm |
| AD 32 - 032 | 5 mm | 25,7 mm |
| AD 32 - 033 | 5 mm | 24,7 mm |
| AD 32 - 023 | 5,8 mm | FARKLI |

Uyarı: Profil ağırlıklarımız teorik olup; teslim anındaki tartımız geçerlidir.

AD 69 T YALITIMLI DOĞRAMA PROFİLLERİ

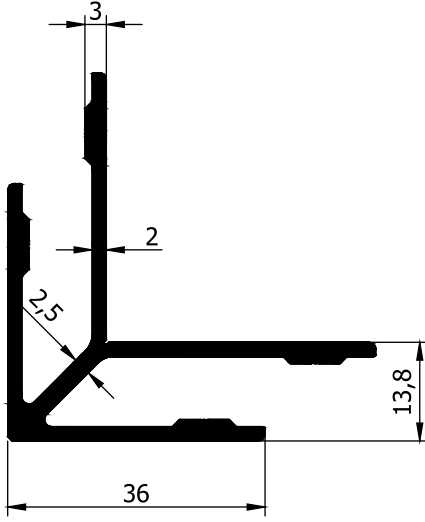

AD 20 - 052 (0,984 Kg/m)

| Kullanılan Prf. | Dış Bölüm Kesim Ölçüsü | İç Bölüm Kesim Ölçüsü |
|---|------------------------|-----------------------|
| AD 32 - 001 AD 32 - 005 AD 32 - 015 | 6,5 mm | 23,5 mm |
| AD 32 - 007 | 5,9 mm | 26,5 mm |
| AD 32 - 013 | 3,5 mm | 26,5 mm |
| AD 32 - 035 AD 32 - 038 AD 32 - 045 | 5,7 mm | 22,7 mm |
| AD 32 - 040 | 5 mm | 25,7 mm |
| AD 32 - 044 | 2,7 mm | 25,7 mm |

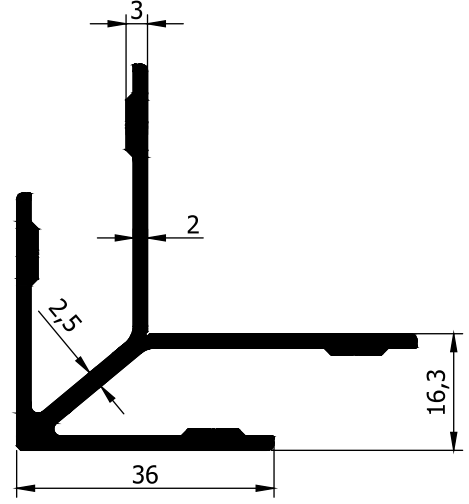

AD 20 - 053 (1,016 Kg/m)

| Kullanılan Prf. | Kesim Ölçüsü |
|-----------------|--------------|
| AD 32 - 009 | 26.5 mm |
| AD 32 - 041 | 25,7 mm |

Uyarı: Profil ağırlıklarımız teorik olup; teslim anındaki tartımız geçerlidir.

AD 69 T YALITIMLI DOĞRAMA PROFİLLERİ

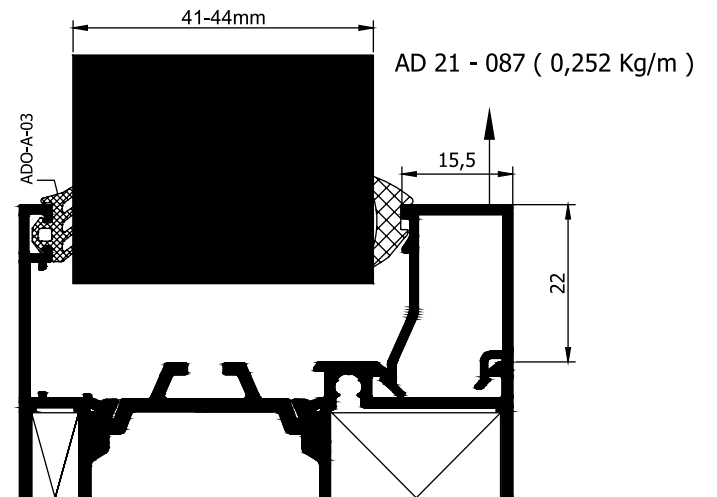
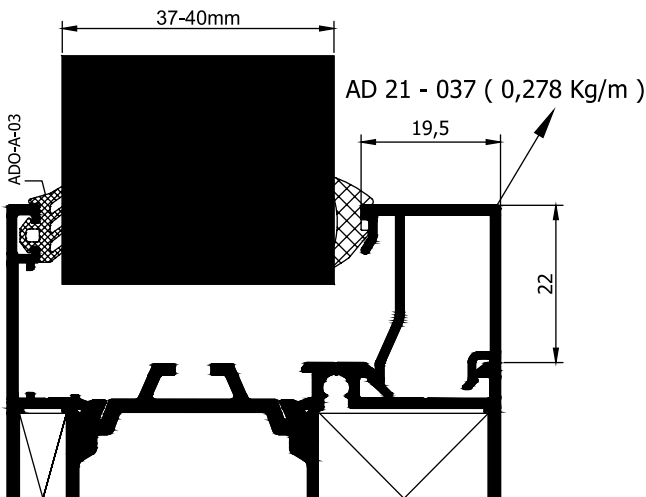
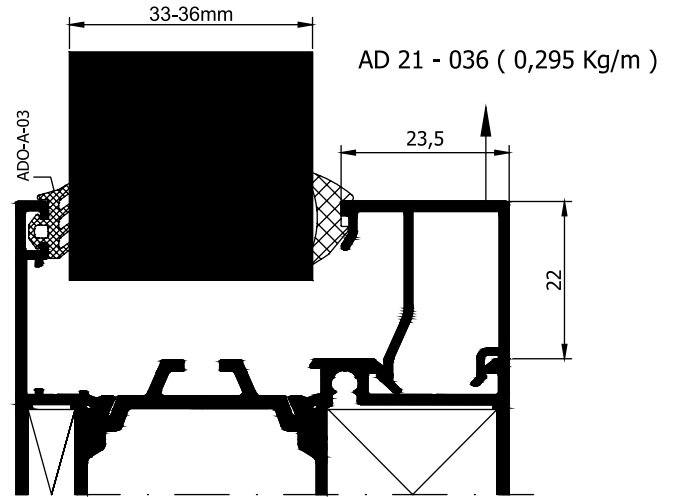
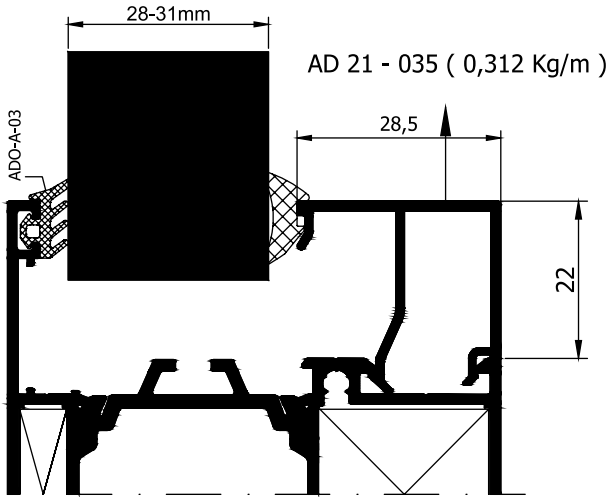
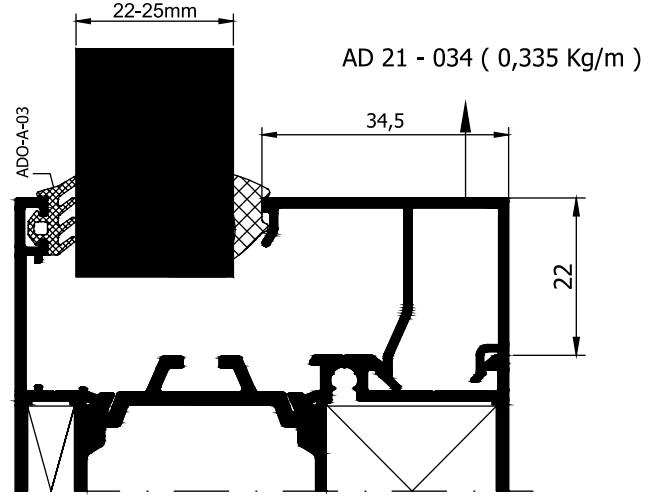
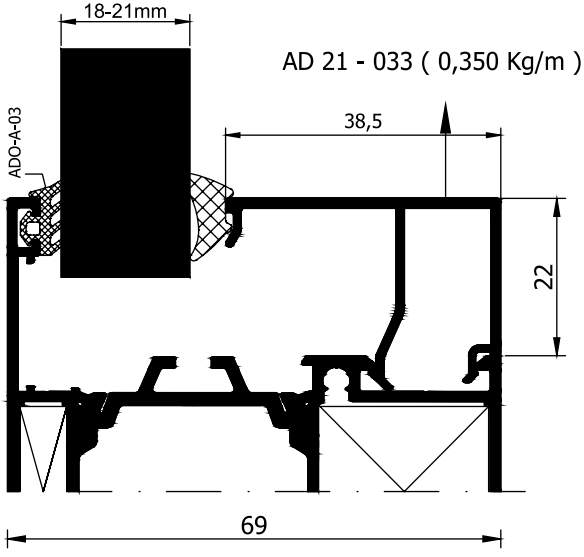





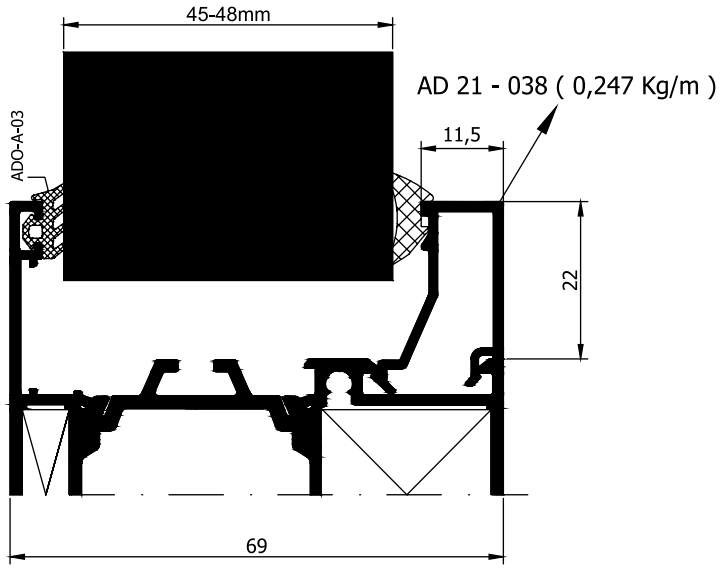



















































Uyarı: Profil ağırlıklarımız teorik olup; teslim anındaki tartımız geçerlidir.

AD 69 T YALITIMLI DOĞRAMA PROFİLLERİ



Uyarı: Profil ağırlıklarımız teorik olup; teslim anındaki tartımız geçerlidir.

AD 69 T YALITIMLI DOĞRAMA PROFİLLERİ

| ÇITA | DIŞ CAM FİTİLİ (3 MM) ADO-A-03 | İÇ CAM FİTİLİ | | İÇ CAM FİTİLİ KALINLIĞI | CAM-PANEL KALINLIĞI | ÇITA | DIŞ CAM FİTİLİ (3 MM) ADO-A-03 | İÇ CAM FİTİLİ | | İÇ CAM FİTİLİ KALINLIĞI | CAM-PANEL KALINLIĞI |
|------------------------|---|---|----------|-------------------------|---------------------|------------------------|--|---|----------|-------------------------|---------------------|
| AD 21 - 033 38.5 mm |  |  | ADO-A-05 | 5 MM | 18 MM | AD 21 - 037 19.5 mm |  |  | ADO-A-05 | 5 MM | 37 MM |
| AD 21 - 033 38.5 mm |  |  | ADO-A-06 | 4 MM | 19 MM | AD 21 - 037 19.5 mm |  |  | ADO-A-06 | 4 MM | 38 MM |
| AD 21 - 033 38.5 mm |  |  | ADO-A-07 | 3 MM | 20 MM | AD 21 - 037 19.5 mm |  |  | ADO-A-07 | 3 MM | 39 MM |
| AD 21 - 033 38.5 mm |  |  | ADO-A-08 | 2 MM | 21 MM | AD 21 - 037 19.5 mm |  |  | ADO-A-08 | 2 MM | 40 MM |
| AD 21 - 034 34.5 mm |  |  | ADO-A-05 | 5 MM | 22 MM | AD 21 - 087 15.5 mm |  |  | ADO-A-05 | 5 MM | 41 MM |
| AD 21 - 034 34.5 mm |  |  | ADO-A-06 | 4 MM | 23 MM | AD 21 - 087 15.5 mm |  |  | ADO-A-06 | 4 MM | 42 MM |
| AD 21 - 034 34.5 mm |  |  | ADO-A-07 | 3 MM | 24 MM | AD 21 - 087 15.5 mm |  |  | ADO-A-07 | 3 MM | 43 MM |
| AD 21 - 034 34.5 mm |  |  | ADO-A-08 | 2 MM | 25 MM | AD 21 - 087 15.5 mm |  |  | ADO-A-08 | 2 MM | 44 MM |
| AD 21 - 035 28.5 mm |  |  | ADO-A-05 | 5 MM | 28 MM | AD 21 - 038 11.5 mm |  |  | ADO-A-05 | 5 MM | 45 MM |
| AD 21 - 035 28.5 mm |  |  | ADO-A-06 | 4 MM | 29 MM | AD 21 - 038 11.5 mm |  |  | ADO-A-06 | 4 MM | 46 MM |
| AD 21 - 035 28.5 mm |  |  | ADO-A-07 | 3 MM | 30 MM | AD 21 - 038 11.5 mm |  |  | ADO-A-07 | 3 MM | 47 MM |
| AD 21 - 035 28.5 mm |  |  | ADO-A-08 | 2 MM | 31 MM | AD 21 - 038 11.5 mm |  |  | ADO-A-08 | 2 MM | 48 MM |
| AD 21 - 036 23.5 mm |  |  | ADO-A-05 | 5 MM | 33 MM | | | | | | |
| AD 21 - 036 23.5 mm |  |  | ADO-A-06 | 4 MM | 34 MM | | | | | | |
| AD 21 - 036 23.5 mm |  |  | ADO-A-07 | 3 MM | 35 MM | | | | | | |
| AD 21 - 036 23.5 mm |  |  | ADO-A-08 | 2 MM | 36 MM | | | | | | |

AD 69 T YALITIMLI DOĞRAMA PROFİLLERİ

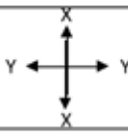
| AD 69 T YALITIMLI DOĞRAMA SİSTEMİ ATALET MOMENTİ TABLOSU (IXX cm ²) | | | | | | | | | | | | | |
|---|----------|---------|---------|---------|---------|---------|---------|---------|---------|---------|---------|---------|---------|
|  | 800 mm | 1000 mm | 1200 mm | 1400 mm | 1600 mm | 1800 mm | 2000 mm | 2200 mm | 2400 mm | 2600 mm | 2800 mm | 3000 mm | 3500 mm |
| | AD32-015 | 15,25 | 18,05 | 20,18 | 21,78 | 22,99 | 23,90 | 24,61 | 25,17 | 25,61 | 25,97 | 26,26 | 26,50 |
| AD32-016 | 16,72 | 19,98 | 22,51 | 24,46 | 25,94 | 27,09 | 27,98 | 28,68 | 29,25 | 29,70 | 30,08 | 30,39 | 30,96 |
| AD32-017 | 18,10 | 21,79 | 24,74 | 27,04 | 28,82 | 30,21 | 31,30 | 32,17 | 32,87 | 33,44 | 33,91 | 34,30 | 35,02 |
| AD32-018 | 19,87 | 24,15 | 27,66 | 30,46 | 32,67 | 34,41 | 35,80 | 36,91 | 37,81 | 38,55 | 39,16 | 39,67 | 40,61 |
| AD32-019 | 23,81 | 29,38 | 34,21 | 38,25 | 41,56 | 44,27 | 46,47 | 48,27 | 49,75 | 50,98 | 52,01 | 52,87 | 54,50 |
| AD32-021 | 57,48 | 67,44 | 76,07 | 83,29 | 89,21 | 94,03 | 97,96 | 101,18 | 103,83 | 106,02 | 107,85 | 109,39 | 112,30 |
| AD32-022 | 99,90 | 114,71 | 128,06 | 139,57 | 149,28 | 157,38 | 164,10 | 169,68 | 174,34 | 178,23 | 181,51 | 184,29 | 189,60 |
| AD32-034 | 20,26 | 24,77 | 28,51 | 31,52 | 33,92 | 35,82 | 37,34 | 38,56 | 39,56 | 40,37 | 41,04 | 41,61 | 42,66 |
| AD32-045 | 17,01 | 20,45 | 23,15 | 25,23 | 26,83 | 28,07 | 29,04 | 29,80 | 30,42 | 30,91 | 31,32 | 31,66 | 32,29 |
| AD32-046 | 18,71 | 22,71 | 25,94 | 28,48 | 30,48 | 32,04 | 33,28 | 34,26 | 35,06 | 35,71 | 36,24 | 36,69 | 37,52 |
| AD32-047 | 21,69 | 26,68 | 30,90 | 34,37 | 37,17 | 39,42 | 41,23 | 42,71 | 43,91 | 44,90 | 45,73 | 46,42 | 47,71 |
| AD32-048 | 25,46 | 31,66 | 37,21 | 41,98 | 45,98 | 49,30 | 52,05 | 54,33 | 56,22 | 57,81 | 59,14 | 60,27 | 62,42 |
| AD32-050 | 66,18 | 78,02 | 88,71 | 97,96 | 105,77 | 112,29 | 117,72 | 122,23 | 125,99 | 129,14 | 131,80 | 134,05 | 138,35 |
| AD32-051 | 115,75 | 133,09 | 149,34 | 163,88 | 176,52 | 187,34 | 196,53 | 204,30 | 210,88 | 216,47 | 221,22 | 225,29 | 233,15 |

| AD 69 T ORTA KAYIT BAĞ LANTI KOMBİNASYON TABLOSU | | |
|--|--------------------------|--------------------------|
| PROFİL KODU | 1. BAĞ LANTI PROFİL KODU | 2. BAĞ LANTI PROFİL KODU |
| AD32-001 | AD21-074 | AD21-075 |
| AD32-002 | AD21-074 | AD21-075 |
| AD32-003 | AD21-074 | AD21-075 |
| AD32-004 | AD21-074 | AD21-075 |
| AD32-005 | AD21-074 | AD21-075 |
| AD32-006 | AD21-074 | AD21-075 |
| AD32-007 | AD21-074 | AD21-076 |
| AD32-008 | AD21-074 | AD21-076 |
| AD32-009 | AD21-074 | AD21-076 |
| AD32-010 | AD21-074 | AD21-076 |
| AD32-011 | AD21-074 | AD21-076 |
| AD32-012 | AD21-074 | AD21-076 |
| AD32-013 | AD21-074 | AD21-076 |
| AD32-014 | AD21-074 | AD21-076 |
| AD32-015 | AD21-074 | AD21-075 |
| AD32-016 | AD21-074 | AD21-075 |
| AD32-017 | AD21-074 | AD21-075 |
| AD32-018 | AD21-074 | AD21-075 |
| AD32-019 | AD21-074 | AD21-075 |
| AD32-020 | AD21-074 | AD21-075 |
| AD32-021 | AD21-074 | AD21-075 |
| AD32-022 | AD21-074 | AD21-075 |
| AD32-023 | AD21-074 | AD21-076 |
| AD32-030 | AD21-074 | AD21-075 |
| AD32-031 | AD21-074 | AD21-076 |
| AD32-032 | AD21-074 | AD21-076 |
| AD32-033 | AD21-074 | AD21-076 |
| AD32-034 | AD21-074 | AD21-075 |
| AD32-035 | AD21-074 | AD21-075 |
| AD32-036 | AD21-074 | AD21-075 |
| AD32-037 | AD21-074 | AD21-075 |
| AD32-038 | AD21-074 | AD21-075 |
| AD32-039 | AD21-074 | AD21-075 |
| AD32-040 | AD21-074 | AD21-076 |
| AD32-041 | AD21-074 | AD21-076 |
| AD32-042 | AD21-074 | AD21-076 |
| AD32-043 | AD21-074 | AD21-076 |
| AD32-044 | AD21-074 | AD21-076 |
| AD32-045 | AD21-074 | AD21-075 |
| AD32-046 | AD21-074 | AD21-075 |
| AD32-047 | AD21-074 | AD21-075 |
| AD32-048 | AD21-074 | AD21-075 |
| AD32-049 | AD21-074 | AD21-075 |
| AD32-050 | AD21-074 | AD21-075 |
| AD32-051 | AD21-074 | AD21-075 |
| AD32-052 | AD21-074 | AD21-077 |
| AD32-053 | AD21-074 | AD21-077 |
| AD32-054 | AD21-074 | AD21-077 |
| AD32-055 | AD21-074 | AD21-077 |

AD 69 T YALITIMLI DOĞRAMA PROFİLLERİ

| AD 69 T YALITIMLI SERİ | | | |
|------------------------|------------------|-----------------------|------|
| PROFİL KODU | KÖŞE ÇAVUŞU KODU | AÇIKLAMA | ADET |
| AD32-001 | 005.002.003.00 | KÖŞE ÇAVUŞU 45x18.7 | 1 |
| AD32-002 | 005.002.003.00 | KÖŞE ÇAVUŞU 45x18.7 | 1 |
| AD32-003 | 005.002.003.00 | KÖŞE ÇAVUŞU 45x18.7 | 1 |
| AD32-004 | 005.002.003.00 | KÖŞE ÇAVUŞU 45x18.7 | 1 |
| AD32-005 | 005.002.003.00 | KÖŞE ÇAVUŞU 45x18.7 | 2 |
| AD32-006 | 005.002.003.00 | KÖŞE ÇAVUŞU 45x18.7 | 2 |
| AD32-007 | 005.002.001.00 | KÖŞE ÇAVUŞU 39.7x15.7 | 1 |
| | 005.002.002.00 | KÖŞE ÇAVUŞU 35x14.2 | 1 |
| AD32-008 | 005.002.001.00 | KÖŞE ÇAVUŞU 39.7x15.7 | 1 |
| | 005.002.002.00 | KÖŞE ÇAVUŞU 35x14.2 | 1 |
| AD32-009 | 005.002.001.00 | KÖŞE ÇAVUŞU 39.7x15.7 | 1 |
| | 005.002.002.00 | KÖŞE ÇAVUŞU 35x14.2 | 1 |
| AD32-010 | 005.002.001.00 | KÖŞE ÇAVUŞU 39.7x15.7 | 1 |
| | 005.002.002.00 | KÖŞE ÇAVUŞU 35x14.2 | 1 |
| AD32-011 | 005.002.001.00 | KÖŞE ÇAVUŞU 39.7x15.7 | 1 |
| | 005.002.002.00 | KÖŞE ÇAVUŞU 35x14.2 | 1 |
| AD32-012 | 005.002.001.00 | KÖŞE ÇAVUŞU 39.7x15.7 | 1 |
| | 005.002.002.00 | KÖŞE ÇAVUŞU 35x14.2 | 1 |
| AD32-013 | 005.002.001.00 | KÖŞE ÇAVUŞU 39.7x15.7 | 1 |
| | 005.002.002.00 | KÖŞE ÇAVUŞU 35x14.2 | 1 |
| AD32-014 | 005.002.001.00 | KÖŞE ÇAVUŞU 39.7x15.7 | 1 |
| | 005.002.002.00 | KÖŞE ÇAVUŞU 35x14.2 | 1 |
| AD32-015 | 005.002.003.00 | KÖŞE ÇAVUŞU 45x18.7 | 2 |
| AD32-016 | 005.002.003.00 | KÖŞE ÇAVUŞU 45x18.7 | 2 |
| AD32-017 | 005.002.003.00 | KÖŞE ÇAVUŞU 45x18.7 | 2 |
| AD32-018 | 005.002.003.00 | KÖŞE ÇAVUŞU 45x18.7 | 2 |
| AD32-019 | 005.002.003.00 | KÖŞE ÇAVUŞU 45x18.7 | 2 |
| AD32-020 | 005.002.003.00 | KÖŞE ÇAVUŞU 45x18.7 | 1 |
| AD32-021 | 005.002.003.00 | KÖŞE ÇAVUŞU 45x18.7 | 2 |
| AD32-022 | 005.002.003.00 | KÖŞE ÇAVUŞU 45x18.7 | 2 |
| AD32-023 | 005.002.001.00 | KÖŞE ÇAVUŞU 39.7x15.7 | 1 |
| | 005.002.002.00 | KÖŞE ÇAVUŞU 35x14.2 | 1 |
| AD32-026 | 005.002.003.00 | KÖŞE ÇAVUŞU 45x18.7 | 1 |
| AD32-027 | 005.002.002.00 | KÖŞE ÇAVUŞU 35x14.2 | 1 |
| AD32-030 | 005.002.003.00 | KÖŞE ÇAVUŞU 45x18.7 | 1 |
| AD32-031 | 005.002.001.00 | KÖŞE ÇAVUŞU 39.7x15.7 | 1 |
| | 005.002.002.00 | KÖŞE ÇAVUŞU 35x14.2 | 1 |
| AD32-032 | 005.002.001.00 | KÖŞE ÇAVUŞU 39.7x15.7 | 1 |
| | 005.002.002.00 | KÖŞE ÇAVUŞU 35x14.2 | 1 |
| AD32-033 | 005.002.001.00 | KÖŞE ÇAVUŞU 39.7x15.7 | 1 |
| | 005.002.002.00 | KÖŞE ÇAVUŞU 35x14.2 | 1 |
| AD32-034 | 005.002.003.00 | KÖŞE ÇAVUŞU 45x18.7 | 2 |
| AD32-035 | 005.002.003.00 | KÖŞE ÇAVUŞU 45x18.7 | 1 |
| AD32-036 | 005.002.003.00 | KÖŞE ÇAVUŞU 45x18.7 | 1 |
| AD32-037 | 005.002.003.00 | KÖŞE ÇAVUŞU 45x18.7 | 1 |
| AD32-038 | 005.002.003.00 | KÖŞE ÇAVUŞU 45x18.7 | 2 |
| AD32-039 | 005.002.003.00 | KÖŞE ÇAVUŞU 45x18.7 | 2 |
| AD32-040 | 005.002.001.00 | KÖŞE ÇAVUŞU 39.7x15.7 | 1 |
| | 005.002.002.00 | KÖŞE ÇAVUŞU 35x14.2 | 1 |
| AD32-041 | 005.002.001.00 | KÖŞE ÇAVUŞU 39.7x15.7 | 1 |
| | 005.002.002.00 | KÖŞE ÇAVUŞU 35x14.2 | 1 |
| AD32-042 | 005.002.001.00 | KÖŞE ÇAVUŞU 39.7x15.7 | 1 |
| | 005.002.002.00 | KÖŞE ÇAVUŞU 35x14.2 | 1 |
| AD32-043 | 005.002.001.00 | KÖŞE ÇAVUŞU 39.7x15.7 | 1 |
| | 005.002.002.00 | KÖŞE ÇAVUŞU 35x14.2 | 1 |
| AD32-044 | 005.002.001.00 | KÖŞE ÇAVUŞU 39.7x15.7 | 1 |
| | 005.002.002.00 | KÖŞE ÇAVUŞU 35x14.2 | 1 |
| AD32-045 | 005.002.003.00 | KÖŞE ÇAVUŞU 45x18.7 | 2 |
| AD32-046 | 005.002.003.00 | KÖŞE ÇAVUŞU 45x18.7 | 2 |

AD 69 T YALITIMLI DOĞRAMA PROFİLLERİ

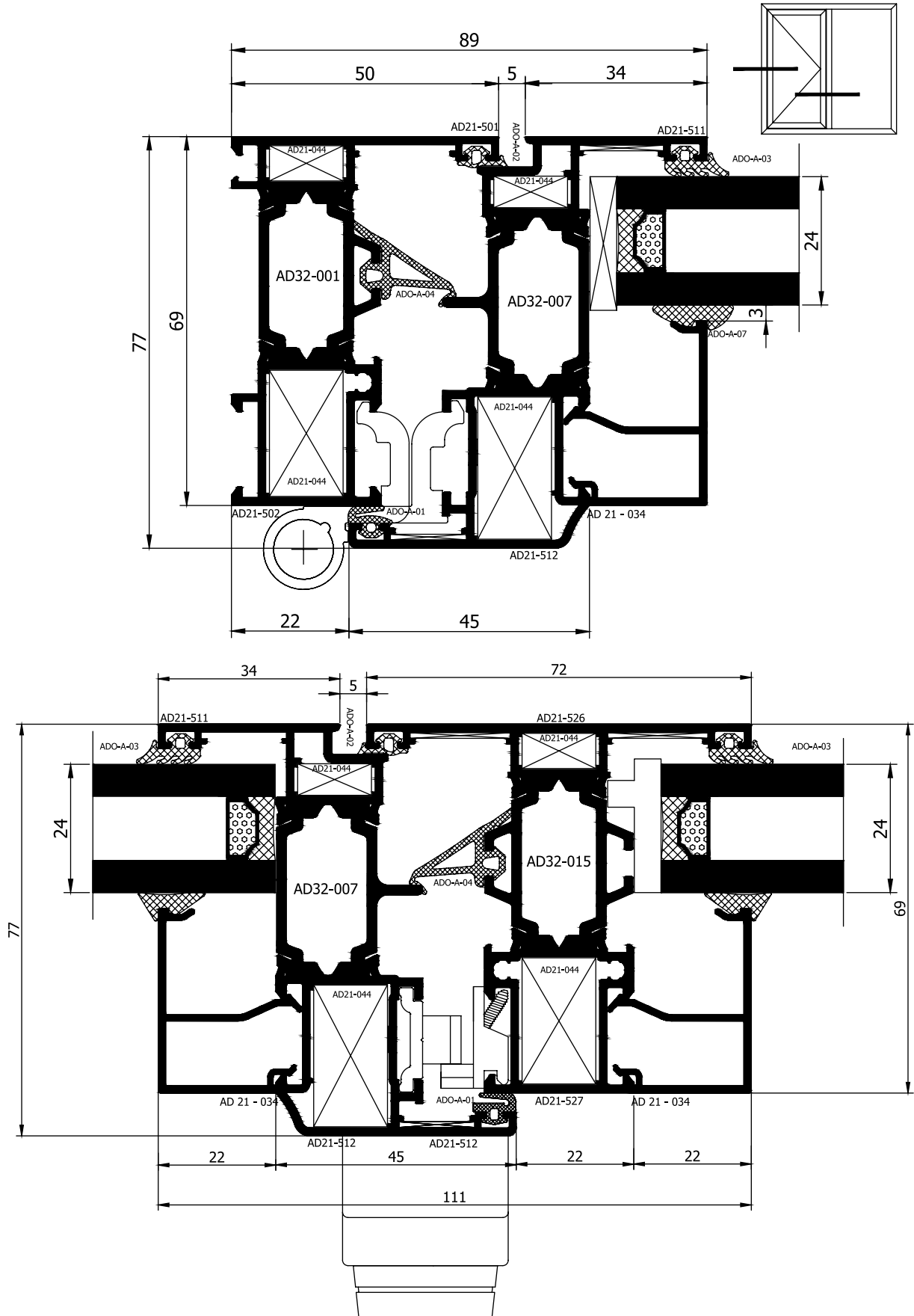

AD 69 T YALITIMLI DOĞRAMA PROFİLLERİ

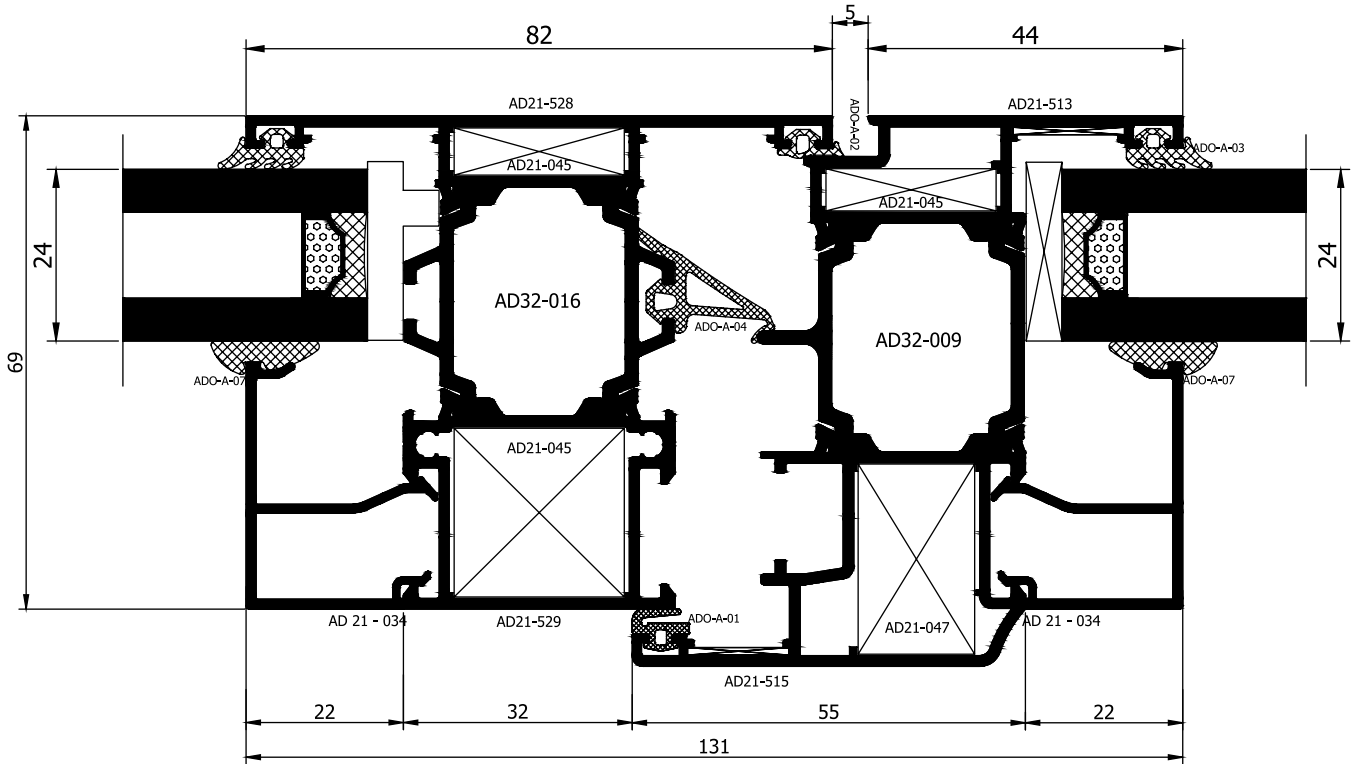
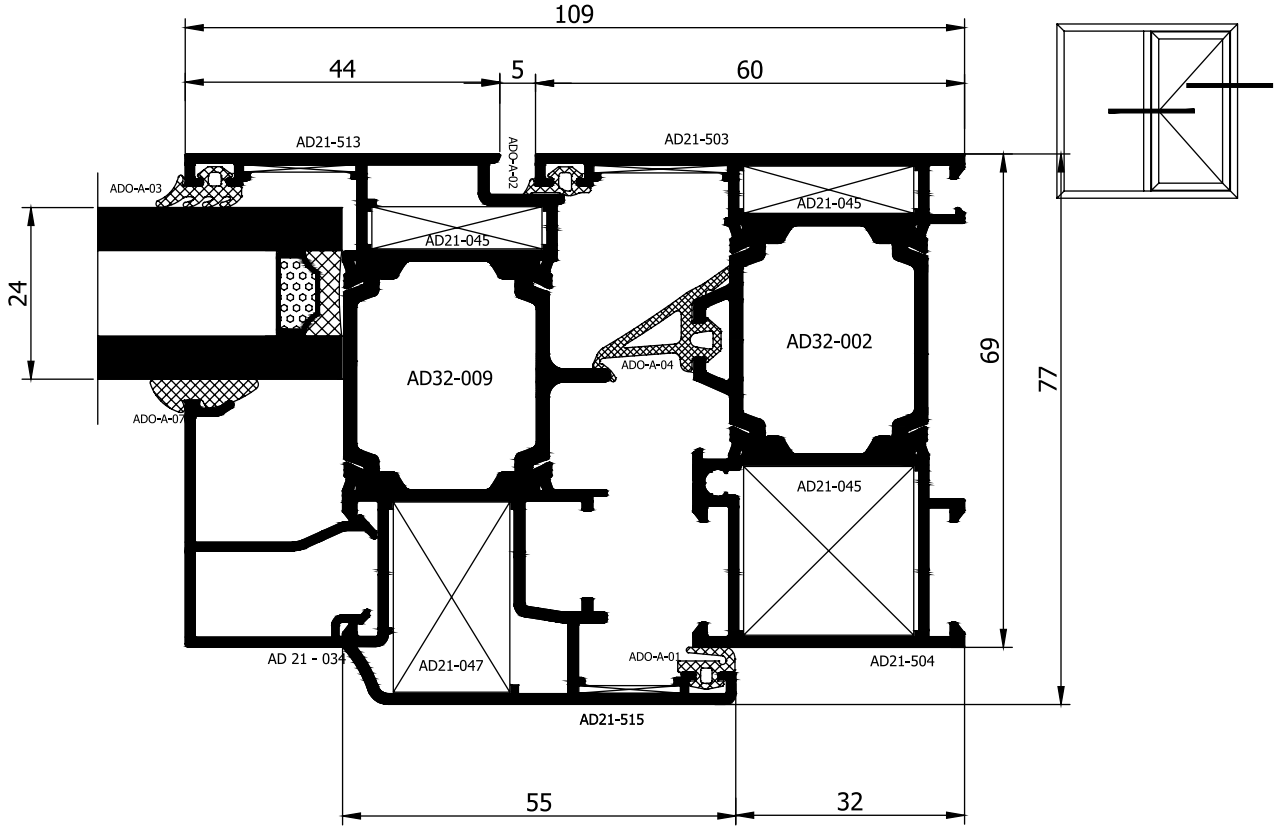

AD 69 T YALITIMLI DOĞRAMA PROFİLLERİ

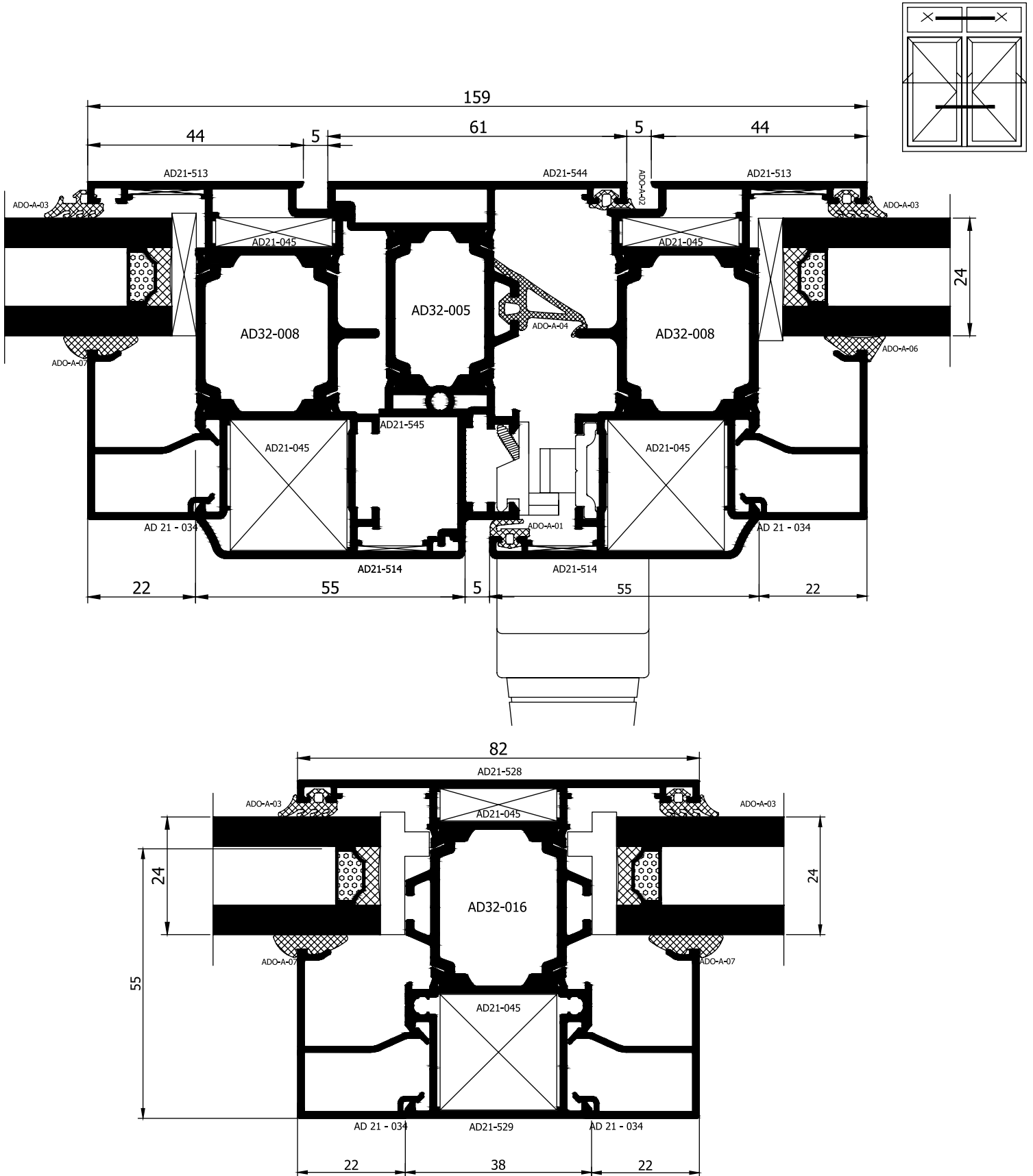

AD 69 T YALITIMLI DOĞRAMA PROFİLLERİ

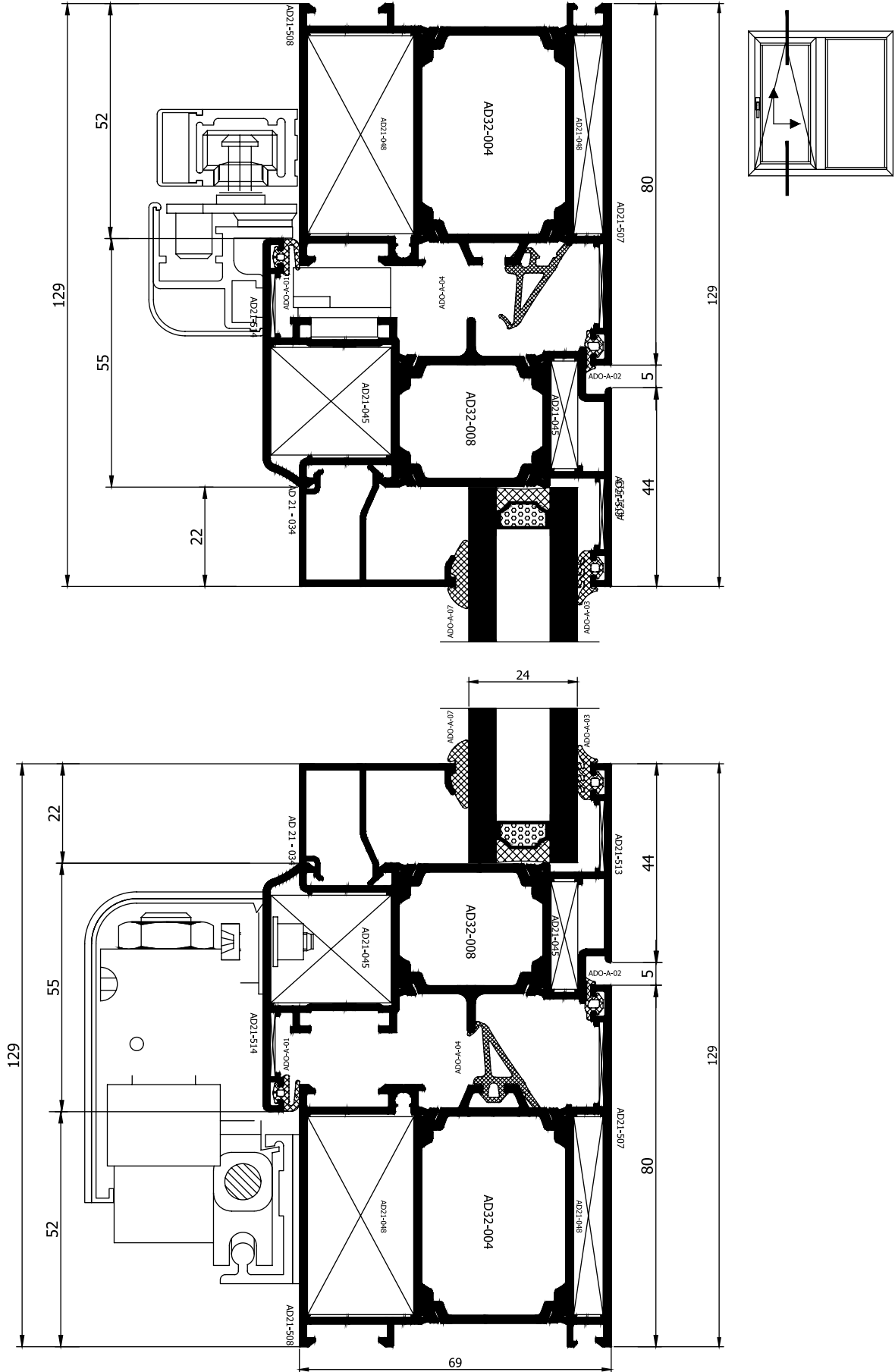

AD 69 T YALITIMLI DOĞRAMA PROFİLLERİ

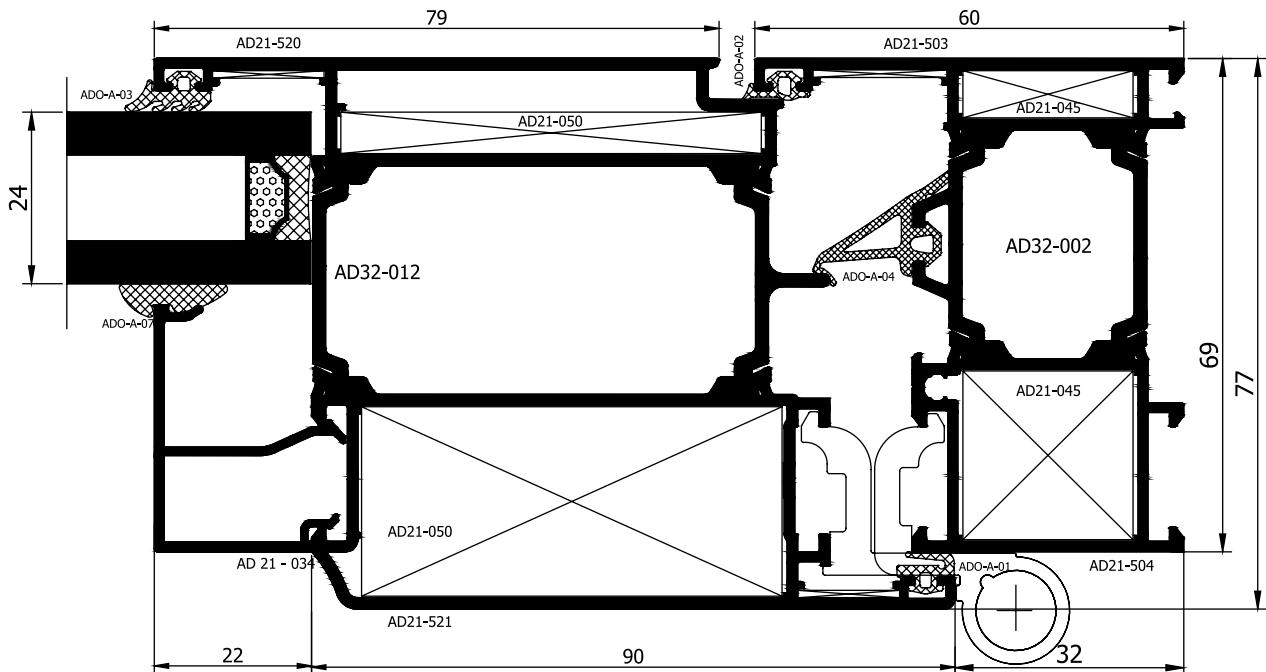
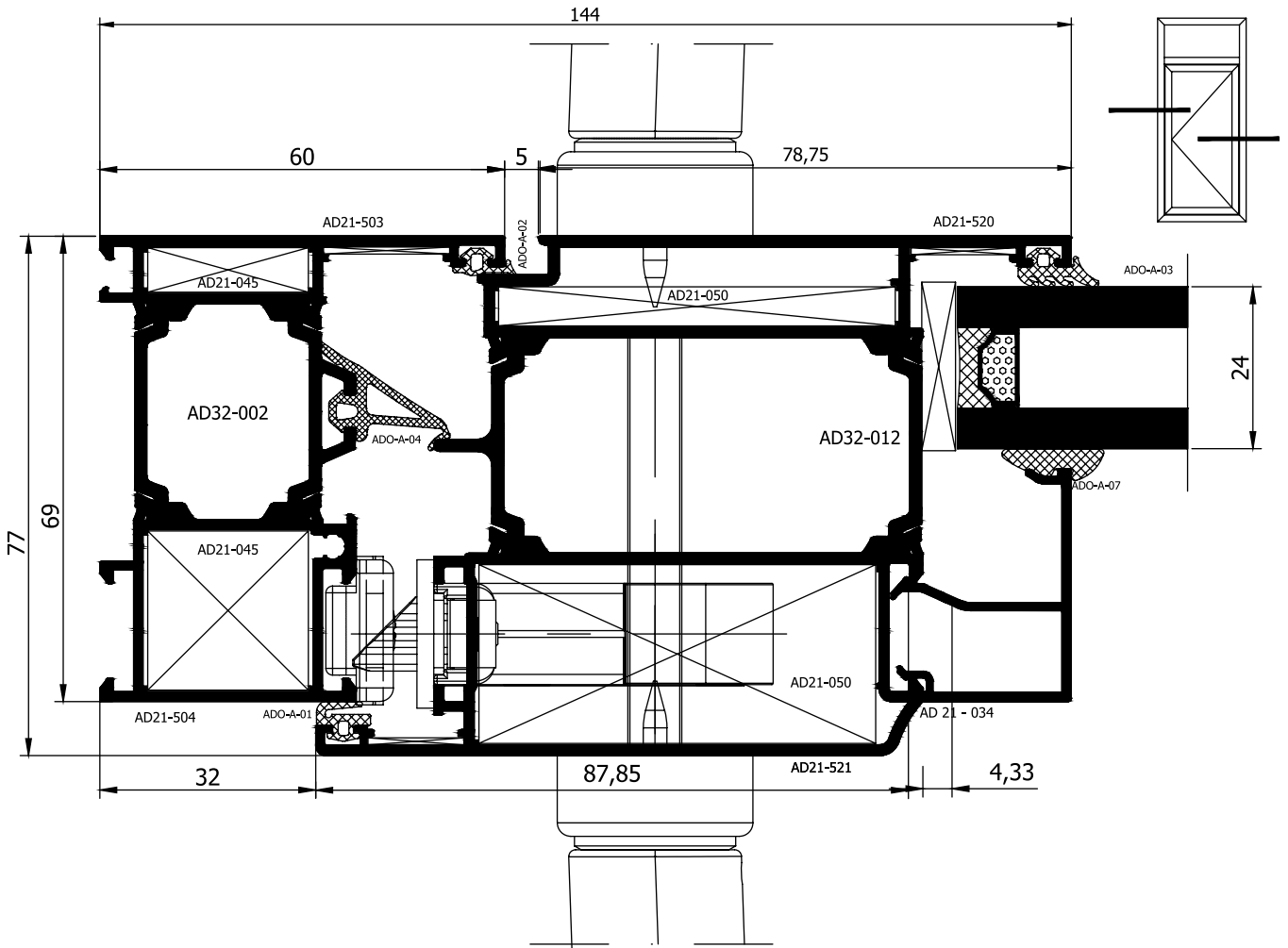

AD 69 T YALITIMLI DOĞRAMA PROFİLLERİ

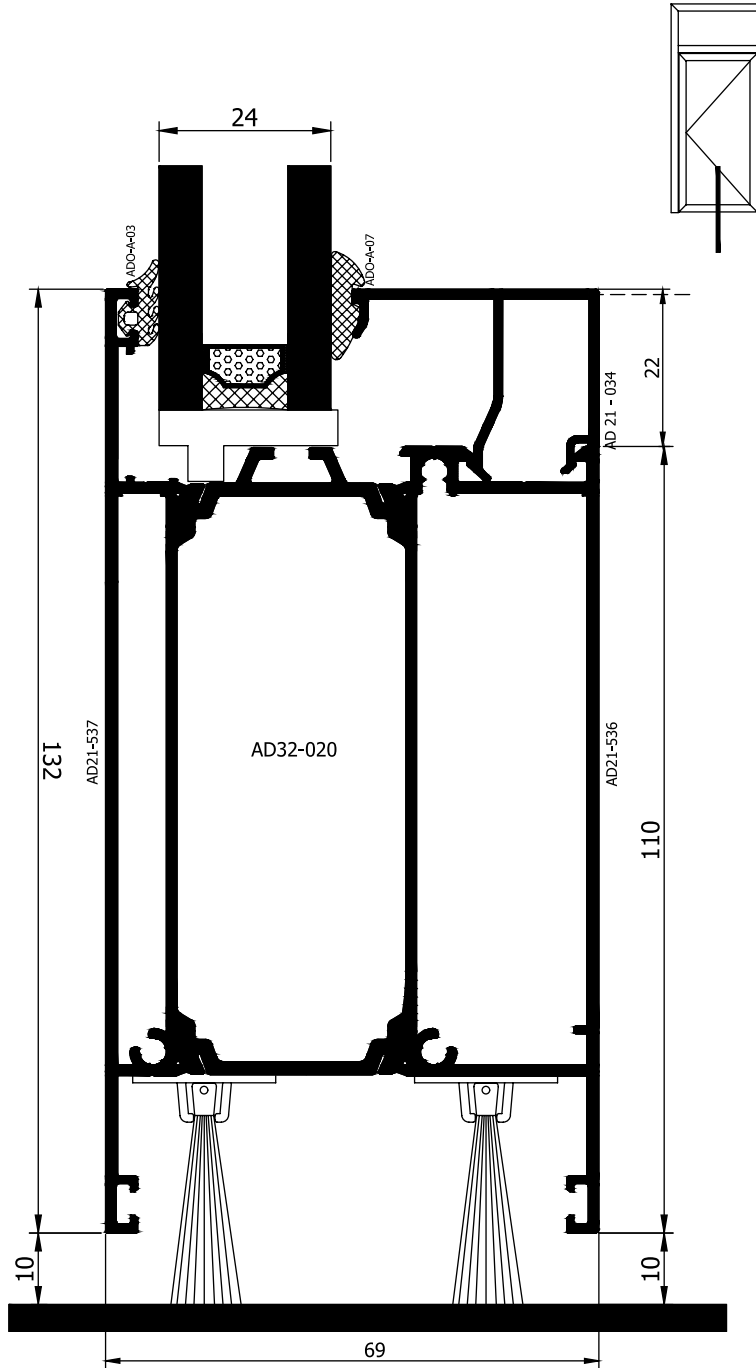

AD 69 T YALITIMLI DOĞRAMA PROFİLLERİ

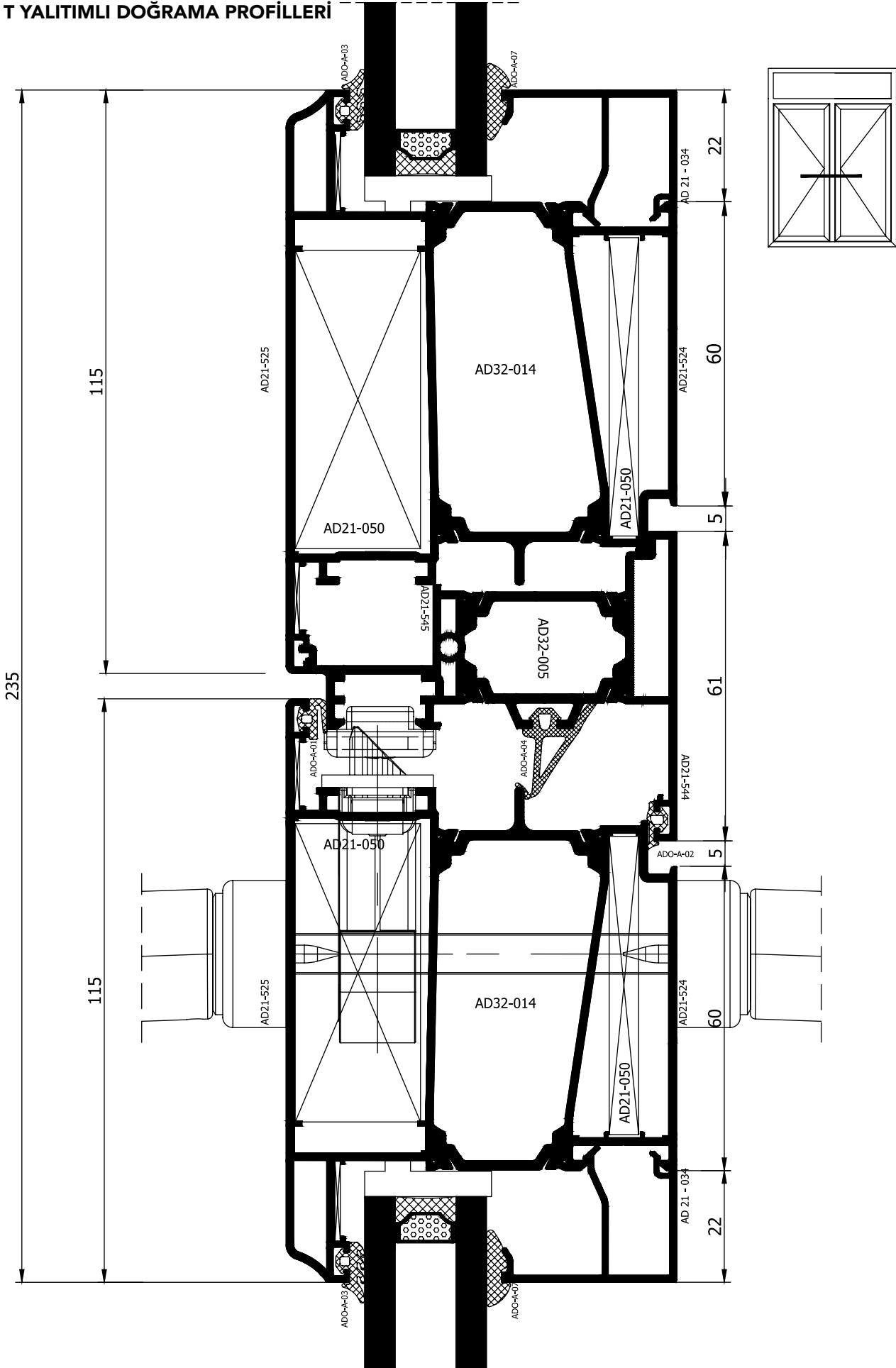

AD 69 T YALITIMLI DOĞRAMA PROFİLLERİ

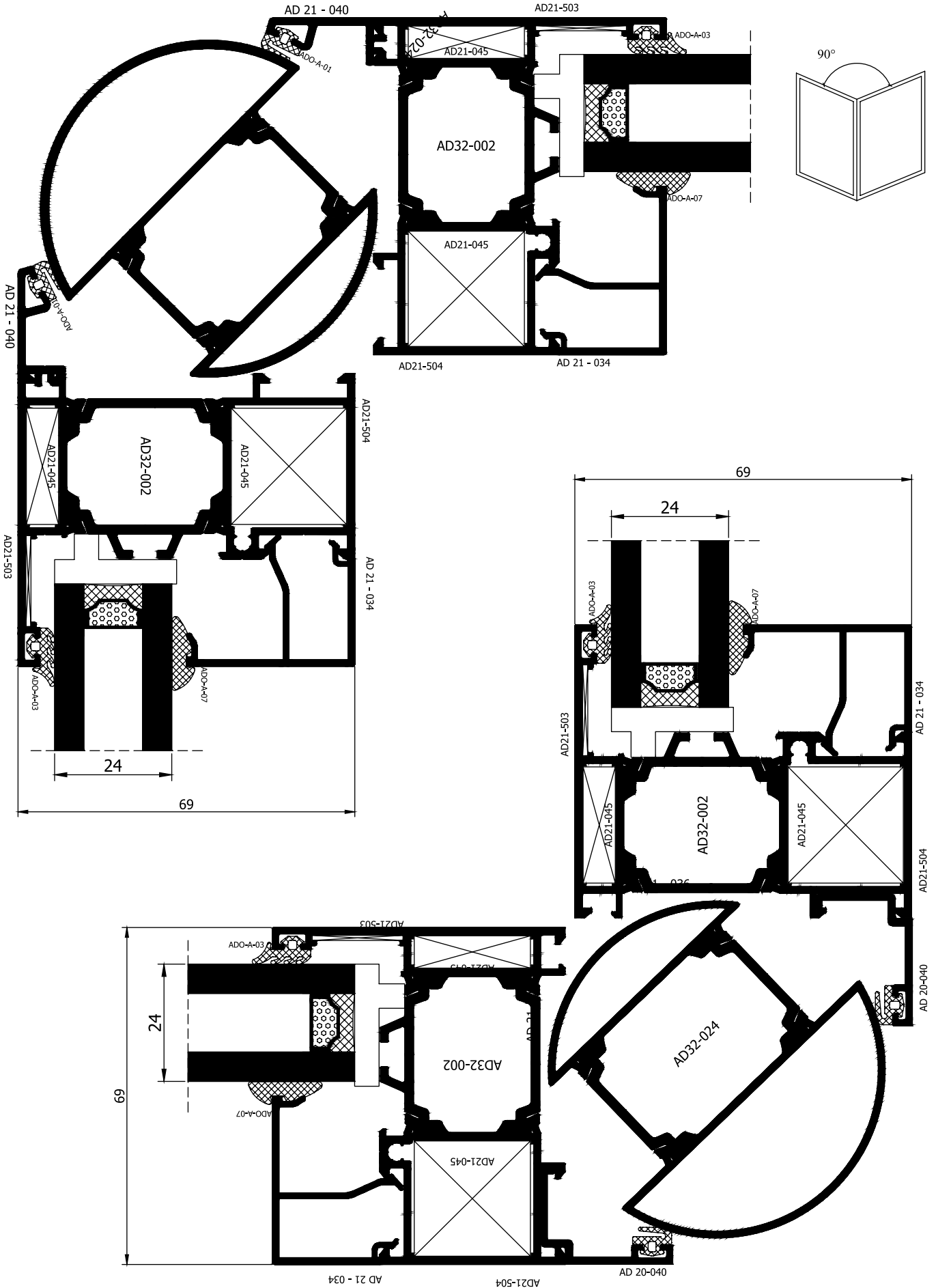

AD 69 T YALITIMLI DOĞRAMA PROFİLLERİ

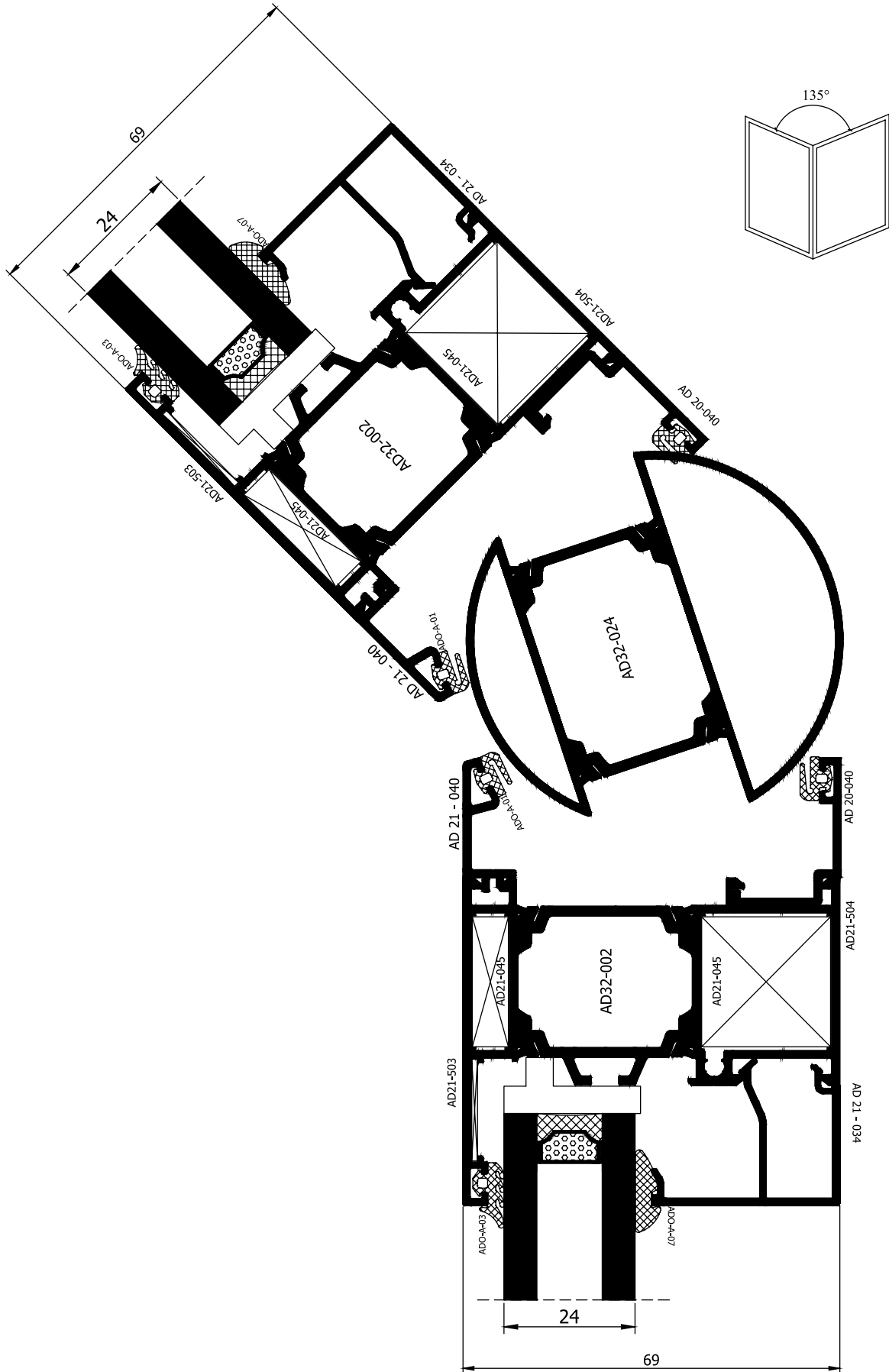





ADO Alüminyum

www.adoaluminyum.com.tr

FABRİKA

Antalya Organize Sanayi Bölgesi 2.Kısım Mah. 21.Cadde No:3 07040 Döşemealtı / ANTALYA
Tel : +90 242 236 40 00 · Faks : +90 242 236 40 90 · Email : info@adoaluminyum.com.tr